

Wiley Series in Probability and Statistics

Introduction to
**Linear
Regression
Analysis**

FIFTH EDITION

DOUGLAS C. MONTGOMERY
ELIZABETH A. PECK
G. GEOFFREY VINING

 **WILEY**

 ftp://

INTRODUCTION TO LINEAR REGRESSION ANALYSIS

WILEY SERIES IN PROBABILITY AND STATISTICS

Established by WALTER A. SHEWHART and SAMUEL S. WILKS

Editors: *David J. Balding, Noel A. C. Cressie, Garrett M. Fitzmaurice,
Harvey Goldstein, Iain M. Johnstone, Geert Molenberghs, David W. Scott,
Adrian F. M. Smith, Ruey S. Tsay, Sanford Weisberg*

Editors Emeriti: *Vic Barnett, J. Stuart Hunter, Joseph B. Kadane, Jozef L. Teugels*

A complete list of the titles in this series appears at the end of this volume.

INTRODUCTION TO LINEAR REGRESSION ANALYSIS

Fifth Edition

DOUGLAS C. MONTGOMERY

Arizona State University
School of Computing, Informatics, and Decision Systems Engineering
Tempe, AZ

ELIZABETH A. PECK

The Coca-Cola Company (retired)
Atlanta, GA

G. GEOFFREY VINING

Virginia Tech
Department of Statistics
Blacksburg, VA



A JOHN WILEY & SONS, INC., PUBLICATION

Copyright © 2012 by John Wiley & Sons, Inc. All rights reserved.

Published by John Wiley & Sons, Inc., Hoboken, New Jersey.
Published simultaneously in Canada.

No part of this publication may be reproduced, stored in a retrieval system, or transmitted in any form or by any means, electronic, mechanical, photocopying, recording, scanning, or otherwise, except as permitted under Section 107 or 108 of the 1976 United States Copyright Act, without either the prior written permission of the Publisher, or authorization through payment of the appropriate per-copy fee to the Copyright Clearance Center, Inc., 222 Rosewood Drive, Danvers, MA 01923, (978) 750-8400, fax (978) 750-4470, or on the web at www.copyright.com. Requests to the Publisher for permission should be addressed to the Permissions Department, John Wiley & Sons, Inc., 111 River Street, Hoboken, NJ 07030, (201) 748-6011, fax (201) 748-6008, or online at <http://www.wiley.com/go/permissions>.

Limit of Liability/Disclaimer of Warranty: While the publisher and author have used their best efforts in preparing this book, they make no representations or warranties with respect to the accuracy or completeness of the contents of this book and specifically disclaim any implied warranties of merchantability or fitness for a particular purpose. No warranty may be created or extended by sales representatives or written sales materials. The advice and strategies contained herein may not be suitable for your situation. You should consult with a professional where appropriate. Neither the publisher nor author shall be liable for any loss of profit or any other commercial damages, including but not limited to special, incidental, consequential, or other damages.

For general information on our other products and services or for technical support, please contact our Customer Care Department within the United States at (800) 762-2974, outside the United States at (317) 572-3993 or fax (317) 572-4002.

Wiley also publishes its books in a variety of electronic formats. Some content that appears in print may not be available in electronic formats. For more information about Wiley products, visit our web site at www.wiley.com.

Library of Congress Cataloging-in-Publication Data:

Montgomery, Douglas C.

Introduction to linear regression analysis / Douglas C. Montgomery, Elizabeth A. Peck, G. Geoffrey Vining. – 5th ed.

p. cm. – (Wiley series in probability and statistics ; 821)

Includes bibliographical references and index.

ISBN 978-0-470-54281-1 (hardback)

1. Regression analysis. I. Peck, Elizabeth A., 1953– II. Vining, G. Geoffrey, 1954– III. Title.

QA278.2.M65 2012

519.5'36–dc23

2012003859

Printed in the United States of America.

10 9 8 7 6 5 4 3 2 1

CONTENTS

PREFACE	xiii
1. INTRODUCTION	1
1.1 Regression and Model Building / 1	
1.2 Data Collection / 5	
1.3 Uses of Regression / 9	
1.4 Role of the Computer / 10	
2. SIMPLE LINEAR REGRESSION	12
2.1 Simple Linear Regression Model / 12	
2.2 Least-Squares Estimation of the Parameters / 13	
2.2.1 Estimation of β_0 and β_1 / 13	
2.2.2 Properties of the Least-Squares Estimators and the Fitted Regression Model / 18	
2.2.3 Estimation of σ^2 / 20	
2.2.4 Alternate Form of the Model / 22	
2.3 Hypothesis Testing on the Slope and Intercept / 22	
2.3.1 Use of t Tests / 22	
2.3.2 Testing Significance of Regression / 24	
2.3.3 Analysis of Variance / 25	
2.4 Interval Estimation in Simple Linear Regression / 29	
2.4.1 Confidence Intervals on β_0 , β_1 and σ^2 / 29	
2.4.2 Interval Estimation of the Mean Response / 30	
2.5 Prediction of New Observations / 33	
2.6 Coefficient of Determination / 35	

2.7	A Service Industry Application of Regression / 37
2.8	Using SAS® and R for Simple Linear Regression / 39
2.9	Some Considerations in the Use of Regression / 42
2.10	Regression Through the Origin / 45
2.11	Estimation by Maximum Likelihood / 51
2.12	Case Where the Regressor x is Random / 52
2.12.1	x and y Jointly Distributed / 53
2.12.2	x and y Jointly Normally Distributed: Correlation Model / 53
	Problems / 58

3. MULTIPLE LINEAR REGRESSION

67

3.1	Multiple Regression Models / 67
3.2	Estimation of the Model Parameters / 70
3.2.1	Least-Squares Estimation of the Regression Coefficients / 71
3.2.2	Geometrical Interpretation of Least Squares / 77
3.2.3	Properties of the Least-Squares Estimators / 79
3.2.4	Estimation of σ^2 / 80
3.2.5	Inadequacy of Scatter Diagrams in Multiple Regression / 82
3.2.6	Maximum-Likelihood Estimation / 83
3.3	Hypothesis Testing in Multiple Linear Regression / 84
3.3.1	Test for Significance of Regression / 84
3.3.2	Tests on Individual Regression Coefficients and Subsets of Coefficients / 88
3.3.3	Special Case of Orthogonal Columns in \mathbf{X} / 93
3.3.4	Testing the General Linear Hypothesis / 95
3.4	Confidence Intervals in Multiple Regression / 97
3.4.1	Confidence Intervals on the Regression Coefficients / 98
3.4.2	CI Estimation of the Mean Response / 99
3.4.3	Simultaneous Confidence Intervals on Regression Coefficients / 100
3.5	Prediction of New Observations / 104
3.6	A Multiple Regression Model for the Patient Satisfaction Data / 104
3.7	Using SAS and R for Basic Multiple Linear Regression / 106
3.8	Hidden Extrapolation in Multiple Regression / 107
3.9	Standardized Regression Coefficients / 111
3.10	Multicollinearity / 117
3.11	Why Do Regression Coefficients Have the Wrong Sign? / 119
	Problems / 121

4. MODEL ADEQUACY CHECKING	129
4.1 Introduction / 129	
4.2 Residual Analysis / 130	
4.2.1 Definition of Residuals / 130	
4.2.2 Methods for Scaling Residuals / 130	
4.2.3 Residual Plots / 136	
4.2.4 Partial Regression and Partial Residual Plots / 143	
4.2.5 Using Minitab®, SAS, and R for Residual Analysis / 146	
4.2.6 Other Residual Plotting and Analysis Methods / 149	
4.3 PRESS Statistic / 151	
4.4 Detection and Treatment of Outliers / 152	
4.5 Lack of Fit of the Regression Model / 156	
4.5.1 Formal Test for Lack of Fit / 156	
4.5.2 Estimation of Pure Error from Near Neighbors / 160	
Problems / 165	
5. TRANSFORMATIONS AND WEIGHTING TO CORRECT MODEL INADEQUACIES	171
5.1 Introduction / 171	
5.2 Variance-Stabilizing Transformations / 172	
5.3 Transformations to Linearize the Model / 176	
5.4 Analytical Methods for Selecting a Transformation / 182	
5.4.1 Transformations on y : The Box–Cox Method / 182	
5.4.2 Transformations on the Regressor Variables / 184	
5.5 Generalized and Weighted Least Squares / 188	
5.5.1 Generalized Least Squares / 188	
5.5.2 Weighted Least Squares / 190	
5.5.3 Some Practical Issues / 191	
5.6 Regression Models with Random Effect / 194	
5.6.1 Subsampling / 194	
5.6.2 The General Situation for a Regression Model with a Single Random Effect / 198	
5.6.3 The Importance of the Mixed Model in Regression / 202	
Problems / 202	
6. DIAGNOSTICS FOR LEVERAGE AND INFLUENCE	211
6.1 Importance of Detecting Influential Observations / 211	
6.2 Leverage / 212	
6.3 Measures of Influence: Cook's D / 215	
6.4 Measures of Influence: $DFFITs$ and $DFBETAs$ / 217	
6.5 A Measure of Model Performance / 219	

6.6	Detecting Groups of Influential Observations / 220	
6.7	Treatment of Influential Observations / 220	
	Problems / 221	
7.	POLYNOMIAL REGRESSION MODELS	223
7.1	Introduction / 223	
7.2	Polynomial Models in One Variable / 223	
7.2.1	Basic Principles / 223	
7.2.2	Piecewise Polynomial Fitting (Splines) / 229	
7.2.3	Polynomial and Trigonometric Terms / 235	
7.3	Nonparametric Regression / 236	
7.3.1	Kernel Regression / 237	
7.3.2	Locally Weighted Regression (Loess) / 237	
7.3.3	Final Cautions / 241	
7.4	Polynomial Models in Two or More Variables / 242	
7.5	Orthogonal Polynomials / 248	
	Problems / 254	
8.	INDICATOR VARIABLES	260
8.1	General Concept of Indicator Variables / 260	
8.2	Comments on the Use of Indicator Variables / 273	
8.2.1	Indicator Variables versus Regression on Allocated Codes / 273	
8.2.2	Indicator Variables as a Substitute for a Quantitative Regressor / 274	
8.3	Regression Approach to Analysis of Variance / 275	
	Problems / 280	
9.	MULTICOLLINEARITY	285
9.1	Introduction / 285	
9.2	Sources of Multicollinearity / 286	
9.3	Effects of Multicollinearity / 288	
9.4	Multicollinearity Diagnostics / 292	
9.4.1	Examination of the Correlation Matrix / 292	
9.4.2	Variance Inflation Factors / 296	
9.4.3	Eigensystem Analysis of $X'X$ / 297	
9.4.4	Other Diagnostics / 302	
9.4.5	SAS and R Code for Generating Multicollinearity Diagnostics / 303	
9.5	Methods for Dealing with Multicollinearity / 303	
9.5.1	Collecting Additional Data / 303	
9.5.2	Model Respecification / 304	
9.5.3	Ridge Regression / 304	

9.5.4	Principal-Component Regression / 313	
9.5.5	Comparison and Evaluation of Biased Estimators / 319	
9.6	Using SAS to Perform Ridge and Principal-Component Regression / 321	
	Problems / 323	
10.	VARIABLE SELECTION AND MODEL BUILDING	327
10.1	Introduction / 327	
10.1.1	Model-Building Problem / 327	
10.1.2	Consequences of Model Misspecification / 329	
10.1.3	Criteria for Evaluating Subset Regression Models / 332	
10.2	Computational Techniques for Variable Selection / 338	
10.2.1	All Possible Regressions / 338	
10.2.2	Stepwise Regression Methods / 344	
10.3	Strategy for Variable Selection and Model Building / 351	
10.4	Case Study: Gorman and Toman Asphalt Data Using SAS / 354	
	Problems / 367	
11.	VALIDATION OF REGRESSION MODELS	372
11.1	Introduction / 372	
11.2	Validation Techniques / 373	
11.2.1	Analysis of Model Coefficients and Predicted Values / 373	
11.2.2	Collecting Fresh Data—Confirmation Runs / 375	
11.2.3	Data Splitting / 377	
11.3	Data from Planned Experiments / 385	
	Problems / 386	
12.	INTRODUCTION TO NONLINEAR REGRESSION	389
12.1	Linear and Nonlinear Regression Models / 389	
12.1.1	Linear Regression Models / 389	
12.1.2	Nonlinear Regression Models / 390	
12.2	Origins of Nonlinear Models / 391	
12.3	Nonlinear Least Squares / 395	
12.4	Transformation to a Linear Model / 397	
12.5	Parameter Estimation in a Nonlinear System / 400	
12.5.1	Linearization / 400	
12.5.2	Other Parameter Estimation Methods / 407	
12.5.3	Starting Values / 408	
12.6	Statistical Inference in Nonlinear Regression / 409	
12.7	Examples of Nonlinear Regression Models / 411	
12.8	Using SAS and R / 412	
	Problems / 416	

13. GENERALIZED LINEAR MODELS	421
13.1 Introduction / 421	
13.2 Logistic Regression Models / 422	
13.2.1 Models with a Binary Response Variable / 422	
13.2.2 Estimating the Parameters in a Logistic Regression Model / 423	
13.2.3 Interpretation of the Parameters in a Logistic Regression Model / 428	
13.2.4 Statistical Inference on Model Parameters / 430	
13.2.5 Diagnostic Checking in Logistic Regression / 440	
13.2.6 Other Models for Binary Response Data / 442	
13.2.7 More Than Two Categorical Outcomes / 442	
13.3 Poisson Regression / 444	
13.4 The Generalized Linear Model / 450	
13.4.1 Link Functions and Linear Predictors / 451	
13.4.2 Parameter Estimation and Inference in the GLM / 452	
13.4.3 Prediction and Estimation with the GLM / 454	
13.4.4 Residual Analysis in the GLM / 456	
13.4.5 Using R to Perform GLM Analysis / 458	
13.4.6 Overdispersion / 461	
Problems / 462	
14. REGRESSION ANALYSIS OF TIME SERIES DATA	474
14.1 Introduction to Regression Models for Time Series Data / 474	
14.2 Detecting Autocorrelation: The Durbin-Watson Test / 475	
14.3 Estimating the Parameters in Time Series Regression Models / 480	
Problems / 496	
15. OTHER TOPICS IN THE USE OF REGRESSION ANALYSIS	500
15.1 Robust Regression / 500	
15.1.1 Need for Robust Regression / 500	
15.1.2 <i>M</i> -Estimators / 503	
15.1.3 Properties of Robust Estimators / 510	

15.2	Effect of Measurement Errors in the Regressors / 511	
15.2.1	Simple Linear Regression / 511	
15.2.2	The Berkson Model / 513	
15.3	Inverse Estimation—The Calibration Problem / 513	
15.4	Bootstrapping in Regression / 517	
15.4.1	Bootstrap Sampling in Regression / 518	
15.4.2	Bootstrap Confidence Intervals / 519	
15.5	Classification and Regression Trees (CART) / 524	
15.6	Neural Networks / 526	
15.7	Designed Experiments for Regression / 529	
	Problems / 537	
APPENDIX A. STATISTICAL TABLES		541
APPENDIX B. DATA SETS FOR EXERCISES		553
APPENDIX C. SUPPLEMENTAL TECHNICAL MATERIAL		574
C.1	Background on Basic Test Statistics / 574	
C.2	Background from the Theory of Linear Models / 577	
C.3	Important Results on SS_R and SS_{Res} / 581	
C.4	Gauss-Markov Theorem, $\text{Var}(\boldsymbol{\varepsilon}) = \sigma^2\mathbf{I}$ / 587	
C.5	Computational Aspects of Multiple Regression / 589	
C.6	Result on the Inverse of a Matrix / 590	
C.7	Development of the PRESS Statistic / 591	
C.8	Development of $S_{(i)}^2$ / 593	
C.9	Outlier Test Based on R -Student / 594	
C.10	Independence of Residuals and Fitted Values / 596	
C.11	Gauss-Markov Theorem, $\text{Var}(\boldsymbol{\varepsilon}) = \mathbf{V}$ / 597	
C.12	Bias in MS_{Res} When the Model Is Underspecified / 599	
C.13	Computation of Influence Diagnostics / 600	
C.14	Generalized Linear Models / 601	
APPENDIX D. INTRODUCTION TO SAS		613
D.1	Basic Data Entry / 614	
D.2	Creating Permanent SAS Data Sets / 618	
D.3	Importing Data from an EXCEL File / 619	
D.4	Output Command / 620	
D.5	Log File / 620	
D.6	Adding Variables to an Existing SAS Data Set / 622	

APPENDIX E. INTRODUCTION TO R TO PERFORM LINEAR REGRESSION ANALYSIS	623
E.1 Basic Background on R / 623	
E.2 Basic Data Entry / 624	
E.3 Brief Comments on Other Functionality in R / 626	
E.4 R Commander / 627	
REFERENCES	628
INDEX	642

PREFACE

Regression analysis is one of the most widely used techniques for analyzing multi-factor data. Its broad appeal and usefulness result from the conceptually logical process of using an equation to express the relationship between a variable of interest (the response) and a set of related predictor variables. Regression analysis is also interesting theoretically because of elegant underlying mathematics and a well-developed statistical theory. Successful use of regression requires an appreciation of both the theory and the practical problems that typically arise when the technique is employed with real-world data.

This book is intended as a text for a basic course in regression analysis. It contains the standard topics for such courses and many of the newer ones as well. It blends both theory and application so that the reader will gain an understanding of the basic principles necessary to apply regression model-building techniques in a wide variety of application environments. The book began as an outgrowth of notes for a course in regression analysis taken by seniors and first-year graduate students in various fields of engineering, the chemical and physical sciences, statistics, mathematics, and management. We have also used the material in many seminars and industrial short courses for professional audiences. We assume that the reader has taken a first course in statistics and has familiarity with hypothesis tests and confidence intervals and the normal, t , χ^2 , and F distributions. Some knowledge of matrix algebra is also necessary.

The computer plays a significant role in the modern application of regression. Today even spreadsheet software has the capability to fit regression equations by least squares. Consequently, we have integrated many aspects of computer usage into the text, including displays of both tabular and graphical output, and general discussions of capabilities of some software packages. We use Minitab®, JMP®, SAS®, and R for various problems and examples in the text. We selected these packages because they are widely used both in practice and in teaching regression and they have good regression. Many of the homework problems require software

for their solution. All data sets in the book are available in electronic form from the publisher. The ftp site ftp://ftp.wiley.com/public/sci_tech_med/introduction_linear_regression hosts the data, problem solutions, PowerPoint files, and other material related to the book.

CHANGES IN THE FIFTH EDITION

We have made extensive changes in this edition of the book. This includes the reorganization of text material, new examples, new exercises, a new chapter on time series regression, and new material on designed experiments for regression models. Our objective was to make the book more useful as both a text and a reference and to update our treatment of certain topics.

Chapter 1 is a general introduction to regression modeling and describes some typical applications of regression. Chapters 2 and 3 provide the standard results for least-squares model fitting in simple and multiple regression, along with basic inference procedures (tests of hypotheses, confidence and prediction intervals). Chapter 4 discusses some introductory aspects of model adequacy checking, including residual analysis and a strong emphasis on residual plots, detection and treatment of outliers, the PRESS statistic, and testing for lack of fit. Chapter 5 discusses how transformations and weighted least squares can be used to resolve problems of model inadequacy or to deal with violations of the basic regression assumptions. Both the Box–Cox and Box–Tidwell techniques for analytically specifying the form of a transformation are introduced. Influence diagnostics are presented in Chapter 6, along with an introductory discussion of how to deal with influential observations. Polynomial regression models and their variations are discussed in Chapter 7. Topics include the basic procedures for fitting and inference for polynomials and discussion of centering in polynomials, hierarchy, piecewise polynomials, models with both polynomial and trigonometric terms, orthogonal polynomials, an overview of response surfaces, and an introduction to nonparametric and smoothing regression techniques. Chapter 8 introduces indicator variables and also makes the connection between regression and analysis-of-variance models. Chapter 9 focuses on the multicollinearity problem. Included are discussions of the sources of multicollinearity, its harmful effects, diagnostics, and various remedial measures. We introduce biased estimation, including ridge regression and some of its variations and principal-component regression. Variable selection and model-building techniques are developed in Chapter 10, including stepwise procedures and all-possible-regressions. We also discuss and illustrate several criteria for the evaluation of subset regression models. Chapter 11 presents a collection of techniques useful for regression model validation.

The first 11 chapters are the nucleus of the book. Many of the concepts and examples flow across these chapters. The remaining four chapters cover a variety of topics that are important to the practitioner of regression, and they can be read independently. Chapter 12 introduces nonlinear regression, and Chapter 13 is a basic treatment of generalized linear models. While these are perhaps not standard topics for a linear regression textbook, they are so important to students and professionals in engineering and the sciences that we would have been seriously remiss without giving an introduction to them. Chapter 14 covers regression

models for time series data. Chapter 15 includes a survey of several important topics, including robust regression, the effect of measurement errors in the regressors, the inverse estimation or calibration problem, bootstrapping regression estimates, classification and regression trees, neural networks, and designed experiments for regression.

In addition to the text material, Appendix C contains brief presentations of some additional topics of a more technical or theoretical nature. Some of these topics will be of interest to specialists in regression or to instructors teaching a more advanced course from the book. Computing plays an important role in many regression courses. Minitab, JMP, SAS, and R are widely used in regression courses. Outputs from all of these packages are provided in the text. Appendix D is an introduction to using SAS for regression problems. Appendix E is an introduction to R.

USING THE BOOK AS A TEXT

Because of the broad scope of topics, this book has great flexibility as a text. For a first course in regression, we would recommend covering Chapters 1 through 10 in detail and then selecting topics that are of specific interest to the audience. For example, one of the authors (D.C.M.) regularly teaches a course in regression to an engineering audience. Topics for that audience include nonlinear regression (because mechanistic models that are almost always nonlinear occur often in engineering), a discussion of neural networks, and regression model validation. Other topics that we would recommend for consideration are multicollinearity (because the problem occurs so often) and an introduction to generalized linear models focusing mostly on logistic regression. G.G.V. has taught a regression course for graduate students in statistics that makes extensive use of the Appendix C material.

We believe the computer should be directly integrated into the course. In recent years, we have taken a notebook computer and computer projector to most classes and illustrated the techniques as they are introduced in the lecture. We have found that this greatly facilitates student understanding and appreciation of the techniques. We also require that the students use regression software for solving the homework problems. In most cases, the problems use real data or are based on real-world settings that represent typical applications of regression.

There is an instructor's manual that contains solutions to all exercises, electronic versions of all data sets, and questions/problems that might be suitable for use on examinations.

ACKNOWLEDGMENTS

We would like to thank all the individuals who provided helpful feedback and assistance in the preparation of this book. Dr. Scott M. Kowalski, Dr. Ronald G. Askin, Dr. Mary Sue Younger, Dr. Russell G. Heikes, Dr. John A. Cornell, Dr. André I. Khuri, Dr. George C. Runger, Dr. Marie Gaudard, Dr. James W. Wisnowski, Dr. Ray Hill, and Dr. James R. Simpson made many suggestions that greatly improved both earlier editions and this fifth edition of the book. We particularly appreciate the many graduate students and professional practitioners who provided feedback,

often in the form of penetrating questions, that led to rewriting or expansion of material in the book. We are also indebted to John Wiley & Sons, the American Statistical Association, and the Biometrika Trustees for permission to use copyrighted material.

DOUGLAS C. MONTGOMERY
ELIZABETH A. PECK
G. GEOFFREY VINING

CHAPTER 1

INTRODUCTION

1.1 REGRESSION AND MODEL BUILDING

Regression analysis is a **statistical technique** for investigating and **modeling the relationship between variables**. Applications of regression are numerous and occur in almost every field, including engineering, the physical and chemical sciences, economics, management, life and biological sciences, and the social sciences. In fact, regression analysis may be the most widely used statistical technique.

As an example of a problem in which regression analysis may be helpful, suppose that an industrial engineer employed by a soft drink beverage bottler is analyzing the product delivery and service operations for vending machines. He suspects that the time required by a route deliveryman to load and service a machine is related to the number of cases of product delivered. The engineer visits 25 randomly chosen retail outlets having vending machines, and the in-outlet delivery time (in minutes) and the volume of product delivered (in cases) are observed for each. The 25 observations are plotted in Figure 1.1*a*. This graph is called a **scatter diagram**. This display clearly suggests a relationship between delivery time and delivery volume; in fact, the impression is that the data points generally, but not exactly, fall along a straight line. Figure 1.1*b* illustrates this straight-line relationship.

If we let y represent delivery time and x represent delivery volume, then the equation of a straight line relating these two variables is

$$y = \beta_0 + \beta_1 x \quad (1.1)$$

where β_0 is the intercept and β_1 is the slope. Now the data points do not fall exactly on a straight line, so Eq. (1.1) should be modified to account for this. Let

Introduction to Linear Regression Analysis, Fifth Edition. Douglas C. Montgomery, Elizabeth A. Peck, G. Geoffrey Vining.

© 2012 John Wiley & Sons, Inc. Published 2012 by John Wiley & Sons, Inc.

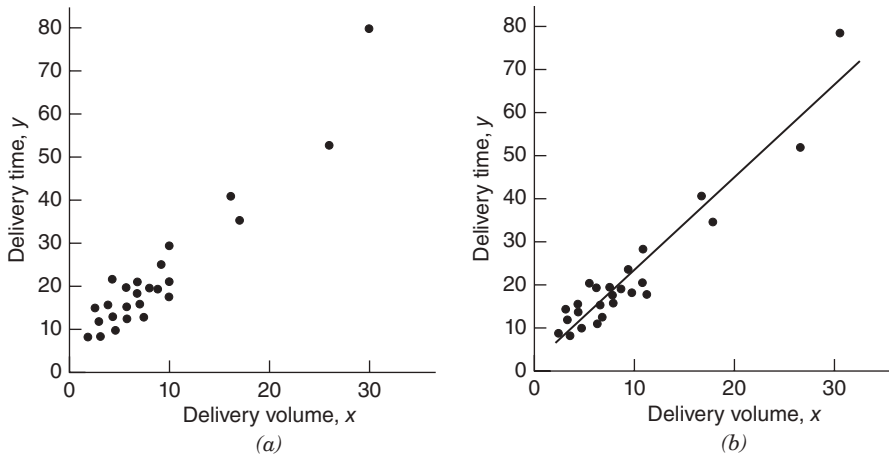

Figure 1.1 (a) Scatter diagram for delivery volume. (b) Straight-line relationship between delivery time and delivery volume.

the difference between the observed value of y and the straight line ($\beta_0 + \beta_1 x$) be an **error** ε . It is convenient to think of ε as a statistical error; that is, it is a random variable that accounts for the failure of the model to fit the data exactly. The error may be made up of the effects of other variables on delivery time, measurement errors, and so forth. Thus, a more plausible model for the delivery time data is

$$y = \beta_0 + \beta_1 x + \varepsilon \quad (1.2)$$

Equation (1.2) is called a **linear regression model**. Customarily x is called the independent variable and y is called the dependent variable. However, this often causes confusion with the concept of statistical independence, so we refer to x as the **predictor** or **regressor** variable and y as the **response** variable. Because Eq. (1.2) involves only one regressor variable, it is called a **simple linear regression model**.

To gain some additional insight into the linear regression model, suppose that we can fix the value of the regressor variable x and observe the corresponding value of the response y . Now if x is fixed, the random component ε on the right-hand side of Eq. (1.2) determines the properties of y . Suppose that the mean and variance of ε are 0 and σ^2 , respectively. Then the mean response at any value of the regressor variable is

$$E(y | x) = \mu_{y|x} = E(\beta_0 + \beta_1 x + \varepsilon) = \beta_0 + \beta_1 x$$

Notice that this is the same relationship that we initially wrote down following inspection of the scatter diagram in Figure 1.1a. The variance of y given any value of x is

$$\text{Var}(y | x) = \sigma_{y|x}^2 = \text{Var}(\beta_0 + \beta_1 x + \varepsilon) = \sigma^2$$

Thus, the true regression model $\mu_{y|x} = \beta_0 + \beta_1 x$ is a line of mean values, that is, the height of the regression line at any value of x is just the expected value of y for that

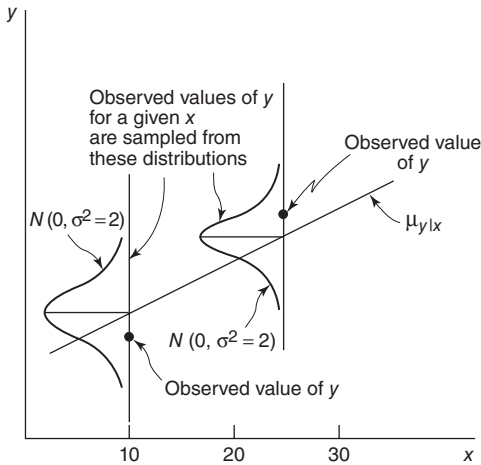

Figure 1.2 How observations are generated in linear regression.

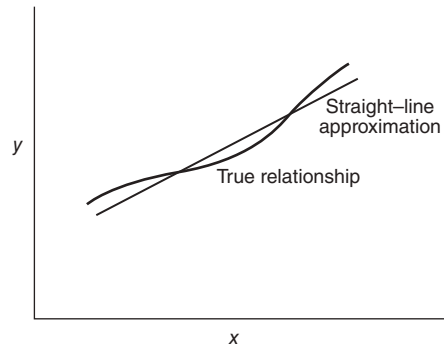

Figure 1.3 Linear regression approximation of a complex relationship.

x . The slope, β_1 can be interpreted as the change in the mean of y for a unit change in x . Furthermore, the variability of y at a particular value of x is determined by the variance of the error component of the model, σ^2 . This implies that there is a distribution of y values at each x and that the variance of this distribution is the same at each x .

For example, suppose that the true regression model relating delivery time to delivery volume is $\mu_{y|x} = 3.5 + 2x$, and suppose that the variance is $\sigma^2 = 2$. Figure 1.2 illustrates this situation. Notice that we have used a normal distribution to describe the random variation in ϵ . Since y is the sum of a constant $\beta_0 + \beta_1 x$ (the mean) and a normally distributed random variable, y is a normally distributed random variable. For example, if $x = 10$ cases, then delivery time y has a normal distribution with mean $3.5 + 2(10) = 23.5$ minutes and variance 2. The variance σ^2 determines the amount of variability or noise in the observations y on delivery time. When σ^2 is small, the observed values of delivery time will fall close to the line, and when σ^2 is large, the observed values of delivery time may deviate considerably from the line.

In almost all applications of regression, the regression equation is only an approximation to the true functional relationship between the variables of interest. These functional relationships are often based on physical, chemical, or other engineering or scientific theory, that is, knowledge of the underlying mechanism. Consequently, these types of models are often called **mechanistic models**. Regression models, on the other hand, are thought of as **empirical models**. Figure 1.3 illustrates a situation where the true relationship between y and x is relatively complex, yet it may be approximated quite well by a linear regression equation. Sometimes the underlying mechanism is more complex, resulting in the need for a more complex approximating function, as in Figure 1.4, where a “piecewise linear” regression function is used to approximate the true relationship between y and x .

Generally regression equations are valid only over the region of the regressor variables contained in the observed data. For example, consider Figure 1.5. Suppose that data on y and x were collected in the interval $x_1 \leq x \leq x_2$. Over this interval the

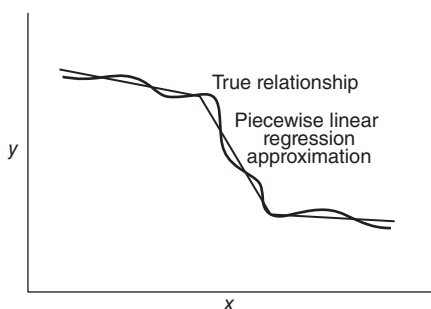

Figure 1.4 Piecewise linear approximation of a complex relationship.

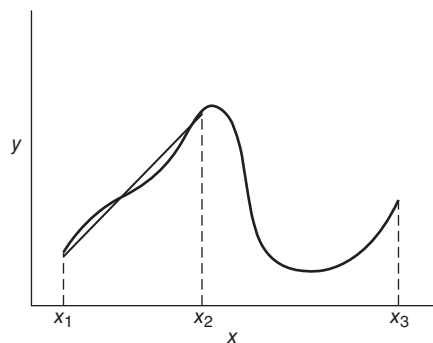

Figure 1.5 The danger of extrapolation in regression.

linear regression equation shown in Figure 1.5 is a good approximation of the true relationship. However, suppose this equation were used to predict values of y for values of the regressor variable in the region $x_2 \leq x \leq x_3$. Clearly the linear regression model is not going to perform well over this range of x because of model error or equation error.

In general, the response variable y may be related to k regressors, x_1, x_2, \dots, x_k , so that

$$y = \beta_0 + \beta_1 x_1 + \beta_2 x_2 + \dots + \beta_k x_k + \varepsilon \quad (1.3)$$

This is called a **multiple linear regression model** because more than one regressor is involved. The adjective linear is employed to indicate that the model is linear in the parameters $\beta_0, \beta_1, \dots, \beta_k$, not because y is a linear function of the x 's. We shall see subsequently that many models in which y is related to the x 's in a nonlinear fashion can still be treated as linear regression models as long as the equation is linear in the β 's.

An important objective of regression analysis is to **estimate the unknown parameters** in the regression model. This process is also called fitting the model to the data. We study several parameter estimation techniques in this book. One of these techniques is the method of least squares (introduced in Chapter 2). For example, the least-squares fit to the delivery time data is

$$\hat{y} = 3.321 + 2.1762x$$

where \hat{y} is the fitted or estimated value of delivery time corresponding to a delivery volume of x cases. This fitted equation is plotted in Figure 1.1*b*.

The next phase of a regression analysis is called **model adequacy checking**, in which the appropriateness of the model is studied and the quality of the fit ascertained. Through such analyses the usefulness of the regression model may be determined. The outcome of adequacy checking may indicate either that the model is reasonable or that the original fit must be modified. Thus, regression analysis is an **iterative** procedure, in which data lead to a model and a fit of the model to the data is produced. The quality of the fit is then investigated, leading either to modification

of the model or the fit or to adoption of the model. This process is illustrated several times in subsequent chapters.

A regression model does not imply a cause-and-effect relationship between the variables. Even though a strong empirical relationship may exist between two or more variables, this cannot be considered evidence that the regressor variables and the response are related in a cause-and-effect manner. To establish causality, the relationship between the regressors and the response must have a basis outside the sample data—for example, the relationship may be suggested by theoretical considerations. Regression analysis can aid in confirming a cause-and-effect relationship, but it cannot be the sole basis of such a claim.

Finally it is important to remember that regression analysis is part of a broader data-analytic approach to problem solving. That is, the regression equation itself may not be the primary objective of the study. It is usually more important to gain insight and understanding concerning the system generating the data.

1.2 DATA COLLECTION

An essential aspect of regression analysis is data collection. Any regression analysis is only as good as the data on which it is based. Three basic methods for collecting data are as follows:

- A retrospective study based on historical data
- An observational study
- A designed experiment

A good data collection scheme can ensure a simplified and a generally more applicable model. A poor data collection scheme can result in serious problems for the analysis and its interpretation. The following example illustrates these three methods.

Example 1.1

Consider the acetone–butyl alcohol distillation column shown in Figure 1.6. The operating personnel are interested in the concentration of acetone in the distillate (product) stream. Factors that may influence this are the reboil temperature, the condensate temperature, and the reflux rate. For this column, operating personnel maintain and archive the following records:

- The concentration of acetone in a test sample taken every hour from the product stream
- The reboil temperature controller log, which is a plot of the reboil temperature
- The condenser temperature controller log
- The nominal reflux rate each hour

The nominal reflux rate is supposed to be constant for this process. Only infrequently does production change this rate. We now discuss how the three different data collection strategies listed above could be applied to this process. ■

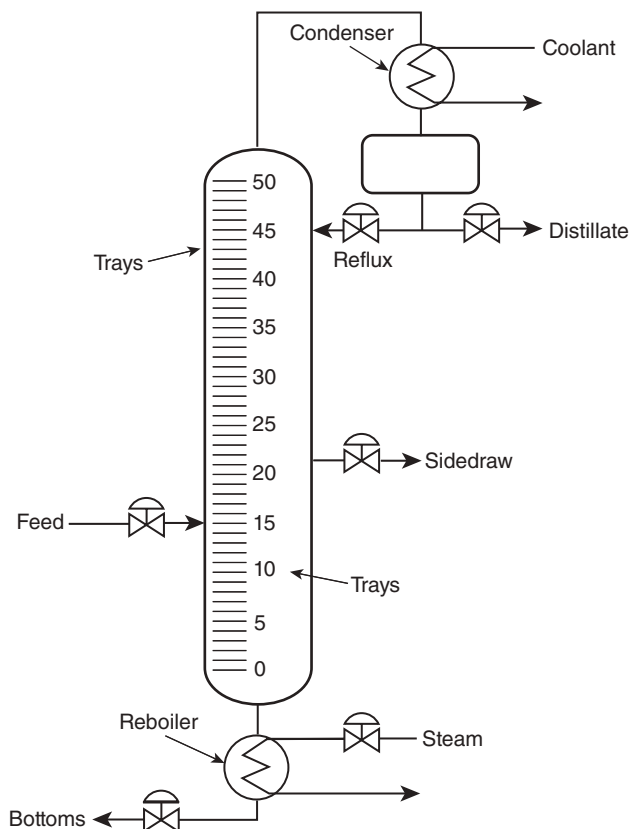

Figure 1.6 Acetone–butyl alcohol distillation column.

Retrospective Study We could pursue a retrospective study that would use either all or a sample of the historical process data over some period of time to determine the relationships among the two temperatures and the reflux rate on the acetone concentration in the product stream. In so doing, we take advantage of previously collected data and minimize the cost of the study. However, these are several problems:

1. We really cannot see the effect of reflux on the concentration since we must assume that it did not vary much over the historical period.
2. The data relating the two temperatures to the acetone concentration do not correspond directly. Constructing an approximate correspondence usually requires a great deal of effort.
3. Production controls temperatures as tightly as possible to specific target values through the use of automatic controllers. Since the two temperatures vary so little over time, we will have a great deal of difficulty seeing their real impact on the concentration.
4. Within the narrow ranges that they do vary, the condensate temperature tends to increase with the reboil temperature. As a result, we will have a great deal

of difficulty separating out the individual effects of the two temperatures. This leads to the problem of **collinearity** or **multicollinearity**, which we discuss in Chapter 9.

Retrospective studies often offer limited amounts of useful information. In general, their primary disadvantages are as follows:

- Some of the relevant data often are missing.
- The reliability and quality of the data are often highly questionable.
- The nature of the data often may not allow us to address the problem at hand.
- The analyst often tries to use the data in ways they were never intended to be used.
- Logs, notebooks, and memories may not explain interesting phenomena identified by the data analysis.

Using historical data always involves the risk that, for whatever reason, some of the data were not recorded or were lost. Typically, historical data consist of information considered critical and of information that is convenient to collect. The convenient information is often collected with great care and accuracy. The essential information often is not. Consequently, historical data often suffer from transcription errors and other problems with data quality. These errors make historical data prone to **outliers**, or observations that are very different from the bulk of the data. A regression analysis is only as reliable as the data on which it is based.

Just because data are convenient to collect does not mean that these data are particularly useful. Often, data not considered essential for routine process monitoring and not convenient to collect do have a significant impact on the process. Historical data cannot provide this information since they were never collected. For example, the ambient temperature may impact the heat losses from our distillation column. On cold days, the column loses more heat to the environment than during very warm days. The production logs for this acetone–butyl alcohol column do not record the ambient temperature. As a result, historical data do not allow the analyst to include this factor in the analysis even though it may have some importance.

In some cases, we try to use data that were collected as surrogates for what we really needed to collect. The resulting analysis is informative only to the extent that these surrogates really reflect what they represent. For example, the nature of the inlet mixture of acetone and butyl alcohol can significantly affect the column's performance. The column was designed for the feed to be a saturated liquid (at the mixture's boiling point). The production logs record the feed temperature but do not record the specific concentrations of acetone and butyl alcohol in the feed stream. Those concentrations are too hard to obtain on a regular basis. In this case, inlet temperature is a surrogate for the nature of the inlet mixture. It is perfectly possible for the feed to be at the correct specific temperature and the inlet feed to be either a subcooled liquid or a mixture of liquid and vapor.

In some cases, the data collected most casually, and thus with the lowest quality, the least accuracy, and the least reliability, turn out to be very influential for explaining our response. This influence may be real, or it may be an artifact related to the inaccuracies in the data. Too many analyses reach invalid conclusions because they

lend too much credence to data that were never meant to be used for the strict purposes of analysis.

Finally, the primary purpose of many analyses is to isolate the root causes underlying interesting phenomena. With historical data, these interesting phenomena may have occurred months or years before. Logs and notebooks often provide no significant insights into these root causes, and memories clearly begin to fade over time. Too often, analyses based on historical data identify interesting phenomena that go unexplained.

Observational Study We could use an observational study to collect data for this problem. As the name implies, an observational study simply observes the process or population. We interact or disturb the process only as much as is required to obtain relevant data. With proper planning, these studies can ensure accurate, complete, and reliable data. On the other hand, these studies often provide very limited information about specific relationships among the data.

In this example, we would set up a data collection form that would allow the production personnel to record the two temperatures and the actual reflux rate at specified times corresponding to the observed concentration of acetone in the product stream. The data collection form should provide the ability to add comments in order to record any interesting phenomena that may occur. Such a procedure would ensure accurate and reliable data collection and would take care of problems 1 and 2 above. This approach also minimizes the chances of observing an outlier related to some error in the data. Unfortunately, an observational study cannot address problems 3 and 4. As a result, observational studies can lend themselves to problems with collinearity.

Designed Experiment The best data collection strategy for this problem uses a designed experiment where we would manipulate the two temperatures and the reflux ratio, which we would call the factors, according to a well-defined strategy, called the experimental design. This strategy must ensure that we can separate out the effects on the acetone concentration related to each factor. In the process, we eliminate any collinearity problems. The specified values of the factors used in the experiment are called the levels. Typically, we use a small number of levels for each factor, such as two or three. For the distillation column example, suppose we use a “high” or +1 and a “low” or -1 level for each of the factors. We thus would use two levels for each of the three factors. A treatment combination is a specific combination of the levels of each factor. Each time we carry out a treatment combination is an experimental run or setting. The experimental design or plan consists of a series of runs.

For the distillation example, a very reasonable experimental strategy uses every possible treatment combination to form a basic experiment with eight different settings for the process. Table 1.1 presents these combinations of high and low levels.

Figure 1.7 illustrates that this design forms a cube in terms of these high and low levels. With each setting of the process conditions, we allow the column to reach equilibrium, take a sample of the product stream, and determine the acetone concentration. We then can draw specific inferences about the effect of these factors. Such an approach allows us to proactively study a population or process.

TABLE 1.1 Designed Experiment for the Distillation Column

Reboil Temperature	Condensate Temperature	Reflux Rate
-1	-1	-1
+1	-1	-1
-1	+1	-1
+1	+1	-1
-1	-1	+1
+1	-1	+1
-1	+1	+1
+1	+1	+1

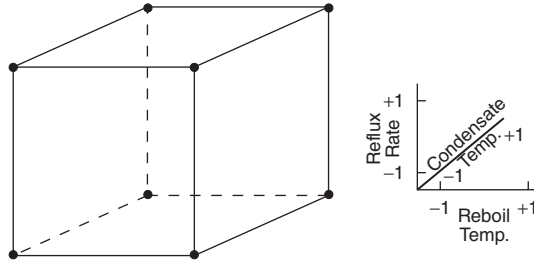
**Figure 1.7** The designed experiment for the distillation column.

1.3 USES OF REGRESSION

Regression models are used for several purposes, including the following:

1. Data description
2. Parameter estimation
3. Prediction and estimation
4. Control

Engineers and scientists frequently use equations to summarize or describe a set of data. Regression analysis is helpful in developing such equations. For example, we may collect a considerable amount of delivery time and delivery volume data, and a regression model would probably be a much more convenient and useful summary of those data than a table or even a graph.

Sometimes parameter estimation problems can be solved by regression methods. For example, chemical engineers use the Michaelis–Menten equation $y = \beta_1 x / (x + \beta_2) + \varepsilon$ to describe the relationship between the velocity of reaction y and concentration x . Now in this model, β_1 is the asymptotic velocity of the reaction, that is, the maximum velocity as the concentration gets large. If a sample of observed values of velocity at different concentrations is available, then the engineer can use regression analysis to fit this model to the data, producing an estimate of the maximum velocity. We show how to fit regression models of this type in Chapter 12.

Many applications of regression involve prediction of the response variable. For example, we may wish to predict delivery time for a specified number of cases of soft drinks to be delivered. These predictions may be helpful in planning delivery activities such as routing and scheduling or in evaluating the productivity of delivery operations. The dangers of extrapolation when using a regression model for prediction because of model or equation error have been discussed previously (see Figure 1.5). However, even when the model form is correct, poor estimates of the model parameters may still cause poor prediction performance.

Regression models may be used for control purposes. For example, a chemical engineer could use regression analysis to develop a model relating the tensile strength of paper to the hardwood concentration in the pulp. This equation could

then be used to control the strength to suitable values by varying the level of hardwood concentration. When a regression equation is used for control purposes, it is important that the variables be related in a causal manner. Note that a cause-and-effect relationship may not be necessary if the equation is to be used only for prediction. In this case it is only necessary that the relationships that existed in the original data used to build the regression equation are still valid. For example, the daily electricity consumption during August in Atlanta, Georgia, may be a good predictor for the maximum daily temperature in August. However, any attempt to reduce the maximum temperature by curtailing electricity consumption is clearly doomed to failure.

1.4 ROLE OF THE COMPUTER

Building a regression model is an iterative process. The model-building process is illustrated in Figure 1.8. It begins by using any theoretical knowledge of the process that is being studied and available data to specify an initial regression model. Graphical data displays are often very useful in specifying the initial model. Then the parameters of the model are estimated, typically by either least squares or maximum likelihood. These procedures are discussed extensively in the text. Then model adequacy must be evaluated. This consists of looking for potential misspecification of the model form, failure to include important variables, including unnecessary variables, or unusual/inappropriate data. If the model is inadequate, then must be made and the parameters estimated again. This process may be repeated several times until an adequate model is obtained. Finally, model validation should be carried out to ensure that the model will produce results that are acceptable in the final application.

A good regression computer program is a necessary tool in the model-building process. However, the routine application of standard regression computer programs often does not lead to successful results. The computer is **not** a substitute for creative thinking about the problem. Regression analysis requires the **intelligent** and **artful** use of the computer. We must learn how to interpret what the computer is telling us and how to incorporate that information in subsequent models. Generally, regression computer programs are part of more general statistics software packages, such as Minitab, SAS, JMP, and R. We discuss and illustrate the use of

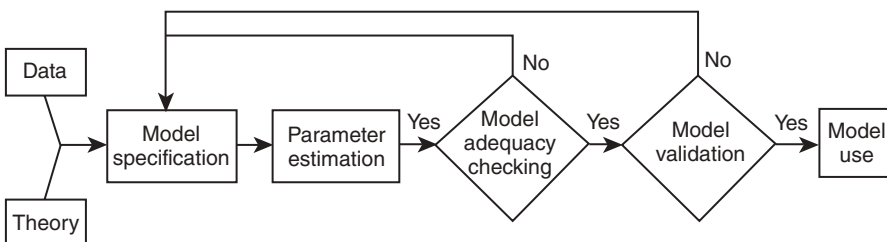

Figure 1.8 Regression model-building process.

these packages throughout the book. Appendix D contains details of the SAS procedures typically used in regression modeling along with basic instructions for their use. Appendix E provides a brief introduction to the R statistical software package. We present R code for doing analyses throughout the text. Without these skills, it is virtually impossible to successfully build a regression model.

CHAPTER 2

SIMPLE LINEAR REGRESSION

2.1 SIMPLE LINEAR REGRESSION MODEL

This chapter considers the **simple linear regression model**, that is, a model with a single regressor x that has a relationship with a response y that is a straight line. This simple linear regression model is

$$y = \beta_0 + \beta_1 x + \varepsilon \quad (2.1)$$

where the intercept β_0 and the slope β_1 are unknown constants and ε is a random error component. The errors are assumed to have mean zero and unknown variance σ^2 . Additionally we usually assume that the errors are uncorrelated. This means that the value of one error does not depend on the value of any other error.

It is convenient to view the regressor x as controlled by the data analyst and measured with negligible error, while the response y is a random variable. That is, there is a probability distribution for y at each possible value for x . The mean of this distribution is

$$E(y|x) = \beta_0 + \beta_1 x \quad (2.2a)$$

and the variance is

$$\text{Var}(y|x) = \text{Var}(\beta_0 + \beta_1 x + \varepsilon) = \sigma^2 \quad (2.2b)$$

Thus, the mean of y is a linear function of x although the variance of y does not depend on the value of x . Furthermore, because the errors are uncorrelated, the responses are also uncorrelated.

The parameters β_0 and β_1 are usually called **regression coefficients**. These coefficients have a simple and often useful interpretation. The slope β_1 is the change in the mean of the distribution of y produced by a unit change in x . If the range of data on x includes $x = 0$, then the intercept β_0 is the mean of the distribution of the response y when $x = 0$. If the range of x does not include zero, then β_0 has no practical interpretation.

2.2 LEAST-SQUARES ESTIMATION OF THE PARAMETERS

The parameters β_0 and β_1 are unknown and must be estimated using sample data. Suppose that we have n pairs of data, say $(y_1, x_1), (y_2, x_2), \dots, (y_n, x_n)$. As noted in Chapter 1, these data may result either from a controlled experiment designed specifically to collect the data, from an observational study, or from existing historical records (a retrospective study).

2.2.1 Estimation of β_0 and β_1

The **method of least squares** is used to estimate β_0 and β_1 . That is, we estimate β_0 and β_1 so that the sum of the squares of the differences between the observations y_i and the straight line is a minimum. From Eq. (2.1) we may write

$$y_i = \beta_0 + \beta_1 x_i + \varepsilon_i, \quad i = 1, 2, \dots, n \quad (2.3)$$

Equation (2.1) maybe viewed as a **population regression model** while Eq. (2.3) is a **sample regression model**, written in terms of the n pairs of data (y_i, x_i) ($i = 1, 2, \dots, n$). Thus, the least-squares criterion is

$$S(\beta_0, \beta_1) = \sum_{i=1}^n (y_i - \beta_0 - \beta_1 x_i)^2 \quad (2.4)$$

The least-squares estimators of β_0 and β_1 , say $\hat{\beta}_0$ and $\hat{\beta}_1$, must satisfy

$$\left. \frac{\partial S}{\partial \beta_0} \right|_{\hat{\beta}_0, \hat{\beta}_1} = -2 \sum_{i=1}^n (y_i - \hat{\beta}_0 - \hat{\beta}_1 x_i) = 0$$

and

$$\left. \frac{\partial S}{\partial \beta_1} \right|_{\hat{\beta}_0, \hat{\beta}_1} = -2 \sum_{i=1}^n (y_i - \hat{\beta}_0 - \hat{\beta}_1 x_i) x_i = 0$$

Simplifying these two equations yields

$$\begin{aligned} n\hat{\beta}_0 + \hat{\beta}_1 \sum_{i=1}^n x_i &= \sum_{i=1}^n y_i \\ \hat{\beta}_0 \sum_{i=1}^n x_i + \hat{\beta}_1 \sum_{i=1}^n x_i^2 &= \sum_{i=1}^n y_i x_i \end{aligned} \quad (2.5)$$

Equations (2.5) are called the **least-squares normal equations**. The solution to the normal equations is

$$\hat{\beta}_0 = \bar{y} - \hat{\beta}_1 \bar{x} \quad (2.6)$$

and

$$\hat{\beta}_1 = \frac{\sum_{i=1}^n y_i x_i - \frac{\left(\sum_{i=1}^n y_i\right)\left(\sum_{i=1}^n x_i\right)}{n}}{\sum_{i=1}^n x_i^2 - \frac{\left(\sum_{i=1}^n x_i\right)^2}{n}} \quad (2.7)$$

where

$$\bar{y} = \frac{1}{n} \sum_{i=1}^n y_i \quad \text{and} \quad \bar{x} = \frac{1}{n} \sum_{i=1}^n x_i$$

are the averages of y_i and x_i , respectively. Therefore, $\hat{\beta}_0$ and $\hat{\beta}_1$ in Eqs. (2.6) and (2.7) are the **least-squares estimators** of the intercept and slope, respectively. The fitted simple linear regression model is then

$$\hat{y} = \hat{\beta}_0 + \hat{\beta}_1 x \quad (2.8)$$

Equation (2.8) gives a point estimate of the mean of y for a particular x .

Since the denominator of Eq. (2.7) is the corrected sum of squares of the x_i and the numerator is the corrected sum of cross products of x_i and y_i , we may write these quantities in a more compact notation as

$$S_{xx} = \sum_{i=1}^n x_i^2 - \frac{\left(\sum_{i=1}^n x_i\right)^2}{n} = \sum_{i=1}^n (x_i - \bar{x})^2 \quad (2.9)$$

and

$$S_{xy} = \sum_{i=1}^n y_i x_i - \frac{\left(\sum_{i=1}^n y_i\right)\left(\sum_{i=1}^n x_i\right)}{n} = \sum_{i=1}^n y_i (x_i - \bar{x}) \quad (2.10)$$

Thus, a convenient way to write Eq. (2.7) is

$$\hat{\beta}_1 = \frac{S_{xy}}{S_{xx}} \quad (2.11)$$

The difference between the observed value y_i and the corresponding fitted value \hat{y}_i is a **residual**. Mathematically the i th residual is

$$e_i = y_i - \hat{y}_i = y_i - (\hat{\beta}_0 + \hat{\beta}_1 x_i), \quad i = 1, 2, \dots, n \quad (2.12)$$

Residuals play an important role in investigating **model adequacy** and in detecting departures from the underlying assumptions. This topic is discussed in subsequent chapters.

Example 2.1 The Rocket Propellant Data

A rocket motor is manufactured by bonding an igniter propellant and a sustainer propellant together inside a metal housing. The shear strength of the bond between the two types of propellant is an important quality characteristic. It is suspected that shear strength is related to the age in weeks of the batch of sustainer propellant. Twenty observations on shear strength and the age of the corresponding batch of propellant have been collected and are shown in Table 2.1. The scatter diagram, shown in Figure 2.1, suggests that there is a strong statistical relationship between shear strength and propellant age, and the tentative assumption of the straight-line model $y = \beta_0 + \beta_1 x + \varepsilon$ appears to be reasonable.

TABLE 2.1 Data for Example 2.1

Observation, i	Shear Strength, y_i (psi)	Age of Propellant, x_i (weeks)
1	2158.70	15.50
2	1678.15	23.75
3	2316.00	8.00
4	2061.30	17.00
5	2207.50	5.50
6	1708.30	19.00
7	1784.70	24.00
8	2575.00	2.50
9	2357.90	7.50
10	2256.70	11.00
11	2165.20	13.00
12	2399.55	3.75
13	1779.80	25.00
14	2336.75	9.75
15	1765.30	22.00
16	2053.50	18.00
17	2414.40	6.00
18	2200.50	12.50
19	2654.20	2.00
20	1753.70	21.50

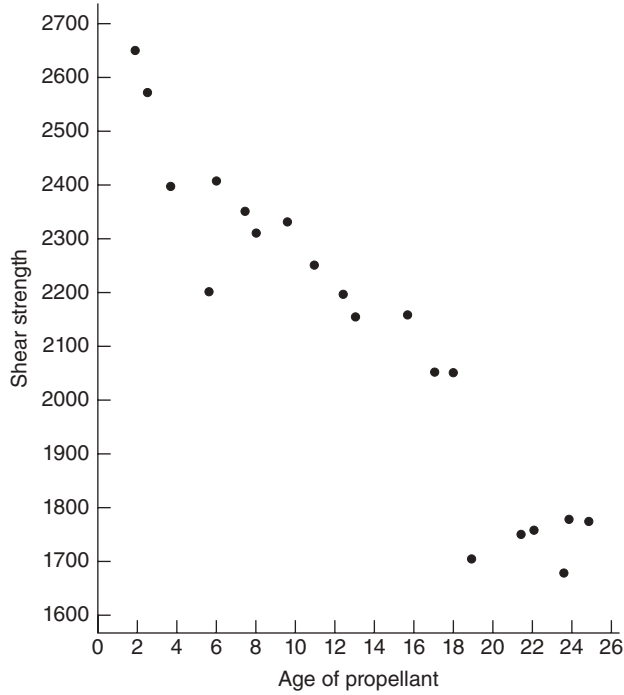

Figure 2.1 Scatter diagram of shear strength versus propellant age, Example 2.1.

To estimate the model parameters, first calculate

$$S_{xx} = \sum_{i=1}^n x_i^2 - \frac{\left(\sum_{i=1}^n x_i\right)^2}{n} = 4677.69 - \frac{71,422.56}{20} = 1106.56$$

and

$$S_{xy} = \sum_{i=1}^n x_i y_i - \frac{\sum_{i=1}^n x_i \sum_{i=1}^n y_i}{n} = 528,492.64 - \frac{(267.25)(42,627.15)}{20} = -41,112.65$$

Therefore, from Eqs. (2.11) and (2.6), we find that

$$\hat{\beta}_1 = \frac{S_{xy}}{S_{xx}} = \frac{-41,112.65}{1106.56} = -37.15$$

and

$$\hat{\beta}_0 = \bar{y} - \hat{\beta}_1 \bar{x} = 2131.3575 - (-37.15)13.3625 = 2627.82$$

TABLE 2.2 Data, Fitted Values, and Residuals for Example 2.1

Observed Value, y_i	Fitted Value, \hat{y}_i	Residual, e_i
2158.70	2051.94	106.76
1678.15	1745.42	-67.27
2316.00	2330.59	-14.59
2061.30	1996.21	65.09
2207.50	2423.48	-215.98
1708.30	1921.90	-213.60
1784.70	1736.14	48.56
2575.00	2534.94	40.06
2357.90	2349.17	8.73
2256.70	2219.13	37.57
2165.20	2144.83	20.37
2399.55	2488.50	-88.95
1799.80	1698.98	80.82
2336.75	2265.58	71.17
1765.30	1810.44	-45.14
2053.50	1959.06	94.44
2414.40	2404.90	9.50
2200.50	2163.40	37.10
2654.20	2553.52	100.68
1753.70	1829.02	-75.32
$\Sigma y_i = 42,627.15$	$\Sigma \hat{y}_i = 42,627.15$	$\Sigma e_i = 0.00$

The least-squares fit is

$$\hat{y} = 2627.82 - 37.15x$$

We may interpret the slope -37.15 as the average weekly decrease in propellant shear strength due to the age of the propellant. Since the lower limit of the x 's is near the origin, the intercept 2627.82 represents the shear strength in a batch of propellant immediately following manufacture. Table 2.2 displays the observed values y_i , the fitted values \hat{y}_i , and the residuals. ■

After obtaining the least-squares fit, a number of interesting questions come to mind:

1. How well does this equation fit the data?
2. Is the model likely to be useful as a predictor?
3. Are any of the basic assumptions (such as constant variance and uncorrelated errors) violated, and if so, how serious is this?

All of these issues must be investigated before the model is finally adopted for use. As noted previously, the residuals play a key role in evaluating model adequacy. Residuals can be viewed as realizations of the model errors ε_i . Thus, to check the constant variance and uncorrelated errors assumption, we must ask ourselves if the residuals look like a random sample from a distribution with these properties. We

TABLE 2.3 Minitab Regression Output for Example 2.1**Regression Analysis**

The regression equation is

Strength = 2628 - 37.2 Age

Predictor	Coef	StDev	T	P
Constant	2627.82	44.18	59.47	0.000
Age	-37.154	2.889	-12.86	0.000

S = 96.11 R-Sq = 90.2% R-Sq(adj) = 89.6%

Analysis of Variance

Source	DF	SS	MS	F	P
Regression	1	1527483	1527483	165.38	0.000
Error	18	166255	9236		
Total	19	1693738			

return to these questions in Chapter 4, where the use of residuals in model adequacy checking is explored.

Computer Output Computer software packages are used extensively in fitting regression models. Regression routines are found in both network and PC-based statistical software, as well as in many popular spreadsheet packages. Table 2.3 presents the output from Minitab, a widely used PC-based statistics package, for the rocket propellant data in Example 2.1. The upper portion of the table contains the fitted regression model. Notice that before rounding the regression coefficients agree with those we calculated manually. Table 2.3 also contains other information about the regression model. We return to this output and explain these quantities in subsequent sections.

2.2.2 Properties of the Least-Squares Estimators and the Fitted Regression Model

The least-squares estimators $\hat{\beta}_0$ and $\hat{\beta}_1$ have several important properties. First, note from Eqs. (2.6) and (2.7) that $\hat{\beta}_0$ and $\hat{\beta}_1$ are **linear combinations** of the observations y_i . For example,

$$\hat{\beta}_1 = \frac{S_{xy}}{S_{xx}} = \sum_{i=1}^n c_i y_i$$

where $c_i = (x_i - \bar{x})/S_{xx}$ for $i = 1, 2, \dots, n$.

The least-squares estimators $\hat{\beta}_0$ and $\hat{\beta}_1$ are **unbiased estimators** of the model parameters β_0 and β_1 . To show this for $\hat{\beta}_1$, consider

$$\begin{aligned} E(\hat{\beta}_1) &= E\left(\sum_{i=1}^n c_i y_i\right) = \sum_{i=1}^n c_i E(y_i) \\ &= \sum_{i=1}^n c_i (\beta_0 + \beta_1 x_i) = \beta_0 \sum_{i=1}^n c_i + \beta_1 \sum_{i=1}^n c_i x_i \end{aligned}$$

since $E(\varepsilon_i) = 0$ by assumption. Now we can show directly that $\sum_{i=1}^n c_i = 0$ and $\sum_{i=1}^n c_i x_i = 1$, so

$$E(\hat{\beta}_1) = \beta_1$$

That is, if we assume that the model is correct [$E(y_i) = \beta_0 + \beta_1 x_i$], then $\hat{\beta}_1$ is an unbiased estimator of β_1 . Similarly we may show that $\hat{\beta}_0$ is an unbiased estimator of β_0 , or

$$E(\hat{\beta}_0) = \beta_0$$

The variance of $\hat{\beta}_1$ is found as

$$\text{Var}(\hat{\beta}_1) = \text{Var}\left(\sum_{i=1}^n c_i y_i\right) = \sum_{i=1}^n c_i^2 \text{Var}(y_i) \quad (2.13)$$

because the observations y_i are uncorrelated, and so the variance of the sum is just the sum of the variances. The variance of each term in the sum is $c_i^2 \text{Var}(y_i)$, and we have assumed that $\text{Var}(y_i) = \sigma^2$; consequently,

$$\text{Var}(\hat{\beta}_1) = \sigma^2 \sum_{i=1}^n c_i^2 = \frac{\sigma^2 \sum_{i=1}^n (x_i - \bar{x})^2}{S_{xx}} = \frac{\sigma^2}{S_{xx}} \quad (2.14)$$

The variance of $\hat{\beta}_0$ is

$$\begin{aligned} \text{Var}(\hat{\beta}_0) &= \text{Var}(\bar{y} - \hat{\beta}_1 \bar{x}) \\ &= \text{Var}(\bar{y}) + \bar{x}^2 \text{Var}(\hat{\beta}_1) - 2\bar{x} \text{Cov}(\bar{y}, \hat{\beta}_1) \end{aligned}$$

Now the variance of \bar{y} is just $\text{Var}(\bar{y}) = \sigma^2/n$, and the covariance between \bar{y} and $\hat{\beta}_1$ can be shown to be zero (see Problem 2.25). Thus,

$$\text{Var}(\hat{\beta}_0) = \text{Var}(\bar{y}) + \bar{x}^2 \text{Var}(\hat{\beta}_1) = \sigma^2 \left(\frac{1}{n} + \frac{\bar{x}^2}{S_{xx}} \right) \quad (2.15)$$

Another important result concerning the quality of the least-squares estimators $\hat{\beta}_0$ and $\hat{\beta}_1$ is the **Gauss-Markov theorem**, which states that for the regression model (2.1) with the assumptions $E(\varepsilon) = 0$, $\text{Var}(\varepsilon) = \sigma^2$, and uncorrelated errors, the least-squares estimators are unbiased and have minimum variance when compared with all other unbiased estimators that are linear combinations of the y_i . We often say that the least-squares estimators are **best linear unbiased estimators**, where “best” implies minimum variance. Appendix C.4 proves the Gauss-Markov theorem for the more general multiple linear regression situation, of which simple linear regression is a special case.

There are several other useful properties of the least-squares fit:

1. The sum of the residuals in any regression model that contains an intercept β_0 is always zero, that is,

$$\sum_{i=1}^n (y_i - \hat{y}_i) = \sum_{i=1}^n e_i = 0$$

This property follows directly from the first normal equation in Eqs. (2.5) and is demonstrated in Table 2.2 for the residuals from Example 2.1. Rounding errors may affect the sum.

2. The sum of the observed values y_i equals the sum of the fitted values \hat{y}_i , or

$$\sum_{i=1}^n y_i = \sum_{i=1}^n \hat{y}_i$$

Table 2.2 demonstrates this result for Example 2.1.

3. The least-squares regression line always passes through the **centroid** [the point (\bar{y}, \bar{x})] of the data.
4. The sum of the residuals weighted by the corresponding value of the regressor variable always equals zero, that is,

$$\sum_{i=1}^n x_i e_i = 0$$

5. The sum of the residuals weighted by the corresponding fitted value always equals zero, that is,

$$\sum_{i=1}^n \hat{y}_i e_i = 0$$

2.2.3 Estimation of σ^2

In addition to estimating β_0 and β_1 , an estimate of σ^2 is required to test hypotheses and construct interval estimates pertinent to the regression model. Ideally we would like this estimate not to depend on the adequacy of the fitted model. This is only possible when there are several observations on y for at least one value of x (see Section 4.5) or when prior information concerning σ^2 is available. When this approach cannot be used, the estimate of σ^2 is obtained from the **residual** or **error sum of squares**,

$$SS_{\text{Res}} = \sum_{i=1}^n e_i^2 = \sum_{i=1}^n (y_i - \hat{y}_i)^2 \quad (2.16)$$

A convenient computing formula for SS_{Res} may be found by substituting $\hat{y}_i = \hat{\beta}_0 + \hat{\beta}_1 x_i$ into Eq. (2.16) and simplifying, yielding

$$SS_{\text{Res}} = \sum_{i=1}^n y_i^2 - n\bar{y}^2 - \hat{\beta}_1 S_{xy} \quad (2.17)$$

But

$$\sum_{i=1}^n y_i^2 - n\bar{y}^2 = \sum_{i=1}^n (y_i - \bar{y})^2 \equiv SS_{\text{T}}$$

is just the corrected sum of squares of the response observations, so

$$SS_{\text{Res}} = SS_{\text{T}} - \hat{\beta}_1 S_{xy} \quad (2.18)$$

The residual sum of squares has $n - 2$ degrees of freedom, because two degrees of freedom are associated with the estimates $\hat{\beta}_0$ and $\hat{\beta}_1$ involved in obtaining \hat{y}_i . Section C.3 shows that the expected value of SS_{Res} is $E(SS_{\text{Res}}) = (n - 2)\sigma^2$, so an **unbiased estimator of σ^2** is

$$\hat{\sigma}^2 = \frac{SS_{\text{Res}}}{n - 2} = MS_{\text{Res}} \quad (2.19)$$

The quantity MS_{Res} is called the **residual mean square**. The square root of $\hat{\sigma}^2$ is sometimes called the **standard error of regression**, and it has the same units as the response variable y .

Because $\hat{\sigma}^2$ depends on the residual sum of squares, any violation of the assumptions on the model errors or any misspecification of the model form may seriously damage the usefulness of $\hat{\sigma}^2$ as an estimate of σ^2 . Because $\hat{\sigma}^2$ is computed from the regression model residuals, we say that it is a **model-dependent** estimate of σ^2 .

Example 2.2 The Rocket Propellant Data

To estimate σ^2 for the rocket propellant data in Example 2.1, first find

$$\begin{aligned} SS_{\text{T}} &= \sum_{i=1}^n y_i^2 - n\bar{y}^2 = \sum_{i=1}^n y_i^2 - \frac{\left(\sum_{i=1}^n y_i\right)^2}{n} \\ &= 92,547,433.45 - \frac{(42,627.15)^2}{20} = 1,693,737.60 \end{aligned}$$

From Eq. (2.18) the residual sum of squares is

$$\begin{aligned} SS_{\text{Res}} &= SS_{\text{T}} - \hat{\beta}_1 S_{xy} \\ &= 1,693,737.60 - (-37.15)(-41,112.65) = 166,402.65 \end{aligned}$$

Therefore, the estimate of σ^2 is computed from Eq. (2.19) as

$$\hat{\sigma}^2 = \frac{SS_{\text{Res}}}{n - 2} = \frac{166,402.65}{18} = 9244.59$$

Remember that this estimate of σ^2 is **model dependent**. Note that this differs slightly from the value given in the Minitab output (Table 2.3) because of rounding. ■

2.2.4 Alternate Form of the Model

There is an alternate form of the simple linear regression model that is occasionally useful. Suppose that we redefine the regressor variable x_i as the deviation from its own average, say $x_i - \bar{x}$. The regression model then becomes

$$\begin{aligned} y_i &= \beta_0 + \beta_1(x_i - \bar{x}) + \beta_1\bar{x} + \varepsilon_i \\ &= (\beta_0 + \beta_1\bar{x}) + \beta_1(x_i - \bar{x}) + \varepsilon_i \\ &= \beta'_0 + \beta_1(x_i - \bar{x}) + \varepsilon_i \end{aligned} \quad (2.20)$$

Note that redefining the regressor variable in Eq. (2.20) has shifted the origin of the x 's from zero to \bar{x} . In order to keep the fitted values the same in both the original and transformed models, it is necessary to modify the original intercept. The relationship between the original and transformed intercept is

$$\beta'_0 = \beta_0 + \beta_1\bar{x} \quad (2.21)$$

It is easy to show that the least-squares estimator of the transformed intercept is $\hat{\beta}'_0 = \bar{y}$. The estimator of the slope is unaffected by the transformation. This alternate form of the model has some advantages. First, the least-squares estimators $\hat{\beta}'_0 = \bar{y}$ and $\hat{\beta}_1 = S_{xy}/S_{xx}$ are **uncorrelated**, that is, $\text{Cov}(\hat{\beta}'_0, \hat{\beta}_1) = 0$. This will make some applications of the model easier, such as finding confidence intervals on the mean of y (see Section 2.4.2). Finally, the fitted model is

$$\hat{y} = \bar{y} + \hat{\beta}_1(x - \bar{x}) \quad (2.22)$$

Although Eqs. (2.22) and (2.8) are equivalent (they both produce the same value of \hat{y} for the same value of x), Eq. (2.22) directly reminds the analyst that the regression model is only valid over the range of x in the **original data**. This region is centered at \bar{x} .

2.3 HYPOTHESIS TESTING ON THE SLOPE AND INTERCEPT

We are often interested in testing hypotheses and constructing confidence intervals about the model parameters. Hypothesis testing is discussed in this section, and Section 2.4 deals with confidence intervals. These procedures require that we make the additional assumption that the model errors ε_i are normally distributed. Thus, the complete assumptions are that the errors are normally and independently distributed with mean 0 and variance σ^2 , abbreviated NID(0, σ^2). In Chapter 4 we discuss how these assumptions can be checked through **residual analysis**.

2.3.1 Use of t Tests

Suppose that we wish to test the hypothesis that the slope equals a constant, say β_{10} . The appropriate hypotheses are

$$H_0: \beta_1 = \beta_{10}, \quad H_1: \beta_1 \neq \beta_{10} \tag{2.23}$$

where we have specified a two-sided alternative. Since the errors ε_i are $NID(0, \sigma^2)$, the observations y_i are $NID(\beta_0 + \beta_1 x_i, \sigma^2)$. Now $\hat{\beta}_1$ is a linear combination of the observations, so $\hat{\beta}_1$ is normally distributed with mean β_1 and variance σ^2/S_{xx} using the mean and variance of $\hat{\beta}_1$ found in Section 2.2.2. Therefore, the statistic

$$Z_0 = \frac{\hat{\beta}_1 - \beta_{10}}{\sqrt{\sigma^2/S_{xx}}}$$

is distributed $N(0, 1)$ if the null hypothesis $H_0: \beta_1 = \beta_{10}$ is true. If σ^2 were known, we could use Z_0 to test the hypotheses (2.23). Typically, σ^2 is unknown. We have already seen that MS_{Res} is an unbiased estimator of σ^2 . Appendix C.3 establishes that $(n - 2)MS_{Res}/\sigma^2$ follows a χ^2_{n-2} distribution and that MS_{Res} and $\hat{\beta}_1$ are independent. By the definition of a t statistic given in Section C.1,

$$t_0 = \frac{\hat{\beta}_1 - \beta_{10}}{\sqrt{MS_{Res}/S_{xx}}} \tag{2.24}$$

follows a t_{n-2} distribution if the null hypothesis $H_0: \beta_1 = \beta_{10}$ is true. The degrees of freedom associated with t_0 are the number of degrees of freedom associated with MS_{Res} . Thus, the ratio t_0 is the test statistic used to test $H_0: \beta_1 = \beta_{10}$. The test procedure computes t_0 and compares the observed value of t_0 from Eq. (2.24) with the upper $\alpha/2$ percentage point of the t_{n-2} distribution ($t_{\alpha/2, n-2}$). This procedure rejects the null hypothesis if

$$|t_0| > t_{\alpha/2, n-2} \tag{2.25}$$

Alternatively, a P -value approach could also be used for decision making.

The denominator of the test statistic, t_0 , in Eq. (2.24) is often called the **estimated standard error**, or more simply, the **standard error** of the slope. That is,

$$se(\hat{\beta}_1) = \sqrt{\frac{MS_{Res}}{S_{xx}}} \tag{2.26}$$

Therefore, we often see t_0 written as

$$t_0 = \frac{\hat{\beta}_1 - \beta_{10}}{se(\hat{\beta}_1)} \tag{2.27}$$

A similar procedure can be used to test hypotheses about the intercept. To test

$$H_0: \beta_0 = \beta_{00}, \quad H_1: \beta_0 \neq \beta_{00} \tag{2.28}$$

we would use the **test statistic**

$$t_0 = \frac{\hat{\beta}_0 - \beta_{00}}{\sqrt{MS_{Res}(1/n + \bar{x}^2/S_{xx})}} = \frac{\hat{\beta}_0 - \beta_{00}}{se(\hat{\beta}_0)} \tag{2.29}$$

where $se(\hat{\beta}_0) = \sqrt{MS_{Res}(1/n + \bar{x}^2/S_x)}$ is the **standard error of the intercept**. We reject the null hypothesis $H_0: \beta_0 = \beta_{00}$ if $|t_0| > t_{\alpha/2, n-2}$.

2.3.2 Testing Significance of Regression

A very important special case of the hypotheses in Eq. (2.23) is

$$H_0: \beta_1 = 0, \quad H_1: \beta_1 \neq 0 \quad (2.30)$$

These hypotheses relate to the **significance of regression**. Failing to reject $H_0: \beta_1 = 0$ implies that there is no linear relationship between x and y . This situation is illustrated in Figure 2.2. Note that this may imply either that x is of little value in explaining the variation in y and that the best estimator of y for any x is $\hat{y} = \bar{y}$ (Figure 2.2a) or that the true relationship between x and y is not linear (Figure 2.2b). Therefore, failing to reject $H_0: \beta_1 = 0$ is equivalent to saying that there is **no linear relationship between y and x** .

Alternatively, if $H_0: \beta_1 = 0$ is rejected, this implies that x is of value in explaining the variability in y . This is illustrated in Figure 2.3. However, rejecting $H_0: \beta_1 = 0$ could mean either that the straight-line model is adequate (Figure 2.3a) or that even

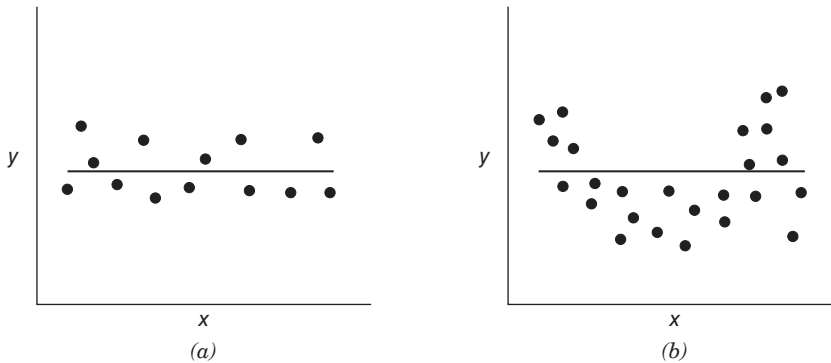

Figure 2.2 Situations where the hypothesis $H_0: \beta_1 = 0$ is not rejected.

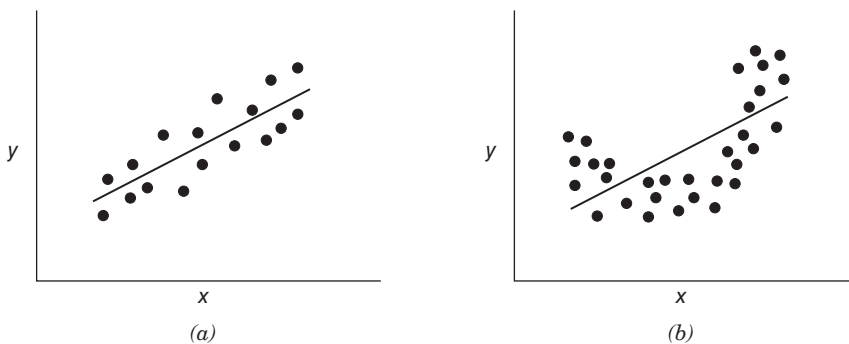

Figure 2.3 Situations where the hypothesis $H_0: \beta_1 = 0$ is rejected.

though there is a linear effect of x , better results could be obtained with the addition of higher order polynomial terms in x (Figure 2.3*b*).

The test procedure for $H_0: \beta_1 = 0$ may be developed from two approaches. The first approach simply makes use of the t statistic in Eq. (2.27) with $\beta_{10} = 0$, or

$$t_0 = \frac{\hat{\beta}_1}{\text{se}(\hat{\beta}_1)}$$

The null hypothesis of significance of regression would be rejected if $|t_0| > t_{\alpha/2, n-2}$.

Example 2.3 The Rocket Propellant Data

We test for significance of regression in the rocket propellant regression model of Example 2.1. The estimate of the slope is $\hat{\beta}_1 = -37.15$, and in Example 2.2, we computed the estimate of σ^2 to be $MS_{\text{Res}} = \hat{\sigma}^2 = 9244.59$. The standard error of the slope is

$$\text{se}(\hat{\beta}_1) = \sqrt{\frac{MS_{\text{Res}}}{S_{xx}}} = \sqrt{\frac{9244.59}{1106.56}} = 2.89$$

Therefore, the test statistic is

$$t_0 = \frac{\hat{\beta}_1}{\text{se}(\hat{\beta}_1)} = \frac{-37.15}{2.89} = -12.85$$

If we choose $\alpha = 0.05$, the critical value of t is $t_{0.025, 18} = 2.101$. Thus, we would reject $H_0: \beta_1 = 0$ and conclude that there is a linear relationship between shear strength and the age of the propellant. ■

Minitab Output The Minitab output in Table 2.3 gives the standard errors of the slope and intercept (called “StDev” in the table) along with the t statistic for testing $H_0: \beta_1 = 0$ and $H_0: \beta_0 = 0$. Notice that the results shown in this table for the slope essentially agree with the manual calculations in Example 2.3. Like most computer software, Minitab uses the P -value approach to hypothesis testing. The P value for the test for significance of regression is reported as $P = 0.000$ (this is a rounded value; the actual P value is 1.64×10^{-10}). Clearly there is strong evidence that strength is linearly related to the age of the propellant. The test statistic for $H_0: \beta_0 = 0$ is reported as $t_0 = 59.47$ with $P = 0.000$. One would feel very confident in claiming that the intercept is not zero in this model.

2.3.3 Analysis of Variance

We may also use an **analysis-of-variance** approach to test significance of regression. The analysis of variance is based on a partitioning of total variability in the response variable y . To obtain this partitioning, begin with the identity

$$y_i - \bar{y} = (\hat{y}_i - \bar{y}) + (y_i - \hat{y}_i) \tag{2.31}$$

Squaring both sides of Eq. (2.31) and summing over all n observations produces

$$\sum_{i=1}^n (y_i - \bar{y})^2 = \sum_{i=1}^n (\hat{y}_i - \bar{y})^2 + \sum_{i=1}^n (y_i - \hat{y}_i)^2 + 2 \sum_{i=1}^n (\hat{y}_i - \bar{y})(y_i - \hat{y}_i)$$

Note that the third term on the right-hand side of this expression can be rewritten as

$$\begin{aligned} 2 \sum_{i=1}^n (\hat{y}_i - \bar{y})(y_i - \hat{y}_i) &= 2 \sum_{i=1}^n \hat{y}_i (y_i - \hat{y}_i) - 2\bar{y} \sum_{i=1}^n (y_i - \hat{y}_i) \\ &= 2 \sum_{i=1}^n \hat{y}_i e_i - 2\bar{y} \sum_{i=1}^n e_i = 0 \end{aligned}$$

since the sum of the residuals is always zero (property 1, Section 2.2.2) and the sum of the residuals weighted by the corresponding fitted value \hat{y}_i is also zero (property 5, Section 2.2.2). Therefore,

$$\sum_{i=1}^n (y_i - \bar{y})^2 = \sum_{i=1}^n (\hat{y}_i - \bar{y})^2 + \sum_{i=1}^n (y_i - \hat{y}_i)^2 \quad (2.32)$$

The left-hand side of Eq. (2.32) is the corrected sum of squares of the observations, SS_T , which measures the total variability in the observations. The two components of SS_T measure, respectively, the amount of variability in the observations y_i accounted for by the regression line and the residual variation left unexplained by the regression line. We recognize $SS_{\text{Res}} = \sum_{i=1}^n (y_i - \hat{y}_i)^2$ as the residual or error sum of squares from Eq. (2.16). It is customary to call $\sum_{i=1}^n (\hat{y}_i - \bar{y})^2$ the **regression** or **model sum of squares**.

Equation (2.32) is the **fundamental analysis-of-variance identity for a regression model**. Symbolically, we usually write

$$SS_T = SS_R + SS_{\text{Res}} \quad (2.33)$$

Comparing Eq. (2.33) with Eq. (2.18) we see that the regression sum of squares may be computed as

$$SS_R = \hat{\beta}_1 S_{xy} \quad (2.34)$$

The **degree-of-freedom** breakdown is determined as follows. The total sum of squares, SS_T , has $df_T = n - 1$ degrees of freedom because one degree of freedom is lost as a result of the constraint $\sum_{i=1}^n (y_i - \bar{y})$ on the deviations $y_i - \bar{y}$. The model or regression sum of squares, SS_R , has $df_R = 1$ degree of freedom because SS_R is completely determined by one parameter, namely, $\hat{\beta}_1$ [see Eq. (2.34)]. Finally, we noted previously that SS_{Res} has $df_{\text{Res}} = n - 2$ degrees of freedom because two

constraints are imposed on the deviations $y_i - \hat{y}_i$ as a result of estimating $\hat{\beta}_0$ and $\hat{\beta}_1$. Note that the degrees of freedom have an additive property:

$$\begin{aligned} df_T &= df_R + df_{Res} \\ n - 1 &= 1 + (n - 2) \end{aligned} \tag{2.35}$$

We can use the usual **analysis-of-variance** F test to test the hypothesis $H_0: \beta_1 = 0$. Appendix C.3 shows that (1) $SS_{Res} = (n - 2)MS_{Res}/\sigma^2$ follows a χ^2_{n-2} distribution; (2) if the null hypothesis $H_0: \beta_1 = 0$ is true, then SS_R/σ^2 follows a χ^2_1 distribution; and (3) SS_{Res} and SS_R are independent. By the definition of an F statistic given in Appendix C.1,

$$F_0 = \frac{SS_R/df_R}{SS_{Res}/df_{Res}} = \frac{SS_R/1}{SS_{Res}/(n-2)} = \frac{MS_R}{MS_{Res}} \tag{2.36}$$

follows the $F_{1,n-2}$ distribution. Appendix C.3 also shows that the expected values of these mean squares are

$$E(MS_{Res}) = \sigma^2, \quad E(MS_R) = \sigma^2 + \beta_1^2 S_{xx}$$

These expected mean squares indicate that if the observed value of F_0 is large, then it is likely that the slope $\beta_1 \neq 0$. Appendix C.3 also shows that if $\beta_1 \neq 0$, then F_0 follows a noncentral F distribution with 1 and $n - 2$ degrees of freedom and a **non-centrality** parameter of

$$\lambda = \frac{\beta_1^2 S_{xx}}{\sigma^2}$$

This noncentrality parameter also indicates that the observed value of F_0 should be large if $\beta_1 \neq 0$. Therefore, to test the hypothesis $H_0: \beta_1 = 0$, compute the test statistic F_0 and reject H_0 if

$$F_0 > F_{\alpha,1,n-2}$$

The test procedure is summarized in Table 2.4.

TABLE 2.4 Analysis of Variance for Testing Significance of Regression

Source of Variation	Sum of Squares	Degrees of Freedom	Mean Square	F_0
Regression	$SS_R = \hat{\beta}_1 S_{xy}$	1	MS_R	MS_R/MS_{Res}
Residual	$SS_{Res} = SS_T - \hat{\beta}_1 S_{xy}$	$n - 2$	MS_{Res}	
Total	SS_T	$n - 1$		

Example 2.4 The Rocket Propellant Data

We will test for significance of regression in the model developed in Example 2.1 for the rocket propellant data. The fitted model is $\hat{y} = 2627.82 - 37.15x$, $SS_T = 1,693,737.60$, and $S_{xy} = -41,112.65$. The regression sum of squares is computed from Eq. (2.34) as

$$SS_R = \hat{\beta}_1 S_{xy} = (-37.15)(-41,112.65) = 1,527,334.95$$

The analysis of variance is summarized in Table 2.5. The computed value of F_0 is 165.21, and from Table A.4, $F_{0.01,1,18} = 8.29$. The P value for this test is 1.66×10^{-10} . Consequently, we reject $H_0: \beta_1 = 0$. ■

Minitab Output The Minitab output in Table 2.3 also presents the analysis-of-variance test significance of regression. Comparing Tables 2.3 and 2.5, we note that there are some slight differences between the manual calculations and those performed by computer for the sums of squares. This is due to rounding the manual calculations to two decimal places. The computed values of the test statistics essentially agree.

More About the t Test We noted in Section 2.3.2 that the t statistic

$$t_0 = \frac{\hat{\beta}_1}{\text{se}(\hat{\beta}_1)} = \frac{\hat{\beta}_1}{\sqrt{MS_{\text{Res}}/S_{xx}}} \quad (2.37)$$

could be used for testing for significance of regression. However, note that on squaring both sides of Eq. (2.37), we obtain

$$t_0^2 = \frac{\hat{\beta}_1^2 S_{xx}}{MS_{\text{Res}}} = \frac{\hat{\beta}_1 S_{xy}}{MS_{\text{Res}}} = \frac{MS_R}{MS_{\text{Res}}} \quad (2.38)$$

Thus, t_0^2 in Eq. (2.38) is identical to F_0 of the analysis-of-variance approach in Eq. (2.36). For example; in the rocket propellant example $t_0 = -12.5$, so $t_0^2 = (-12.5)^2 = 156.25 \approx F_0 = 165.21$. In general, the square of a t random variable with f degrees of freedom is an F random variable with one and f degrees of freedom in the numerator and denominator, respectively. Although the t test for $H_0: \beta_1 = 0$ is equivalent to the F test in simple linear regression, the t test is somewhat more adaptable, as it could be used for one-sided alternative hypotheses (either $H_1: \beta_1 < 0$ or $H_1: \beta_1 > 0$), while the F test considers only the two-sided alternative. Regression

TABLE 2.5 Analysis-of-Variance Table for the Rocket Propellant Regression Model

Source of Variation	Sum of Squares	Degrees of Freedom	Mean Square	F_0	P value
Regression	1,527,334.95	1	1,527,334.95	165.21	1.66×10^{-10}
Residual	166,402.65	18	9,244.59		
Total	1,693,737.60	19			

computer programs routinely produce both the analysis of variance in Table 2.4 and the t statistic. Refer to the Minitab output in Table 2.3.

The real usefulness of the analysis of variance is in **multiple regression models**. We discuss multiple regression in the next chapter.

Finally, remember that deciding that $\beta_1 = 0$ is a very important conclusion that is only **aided** by the t or F test. The inability to show that the slope is not statistically different from zero may not necessarily mean that y and x are unrelated. It may mean that our ability to detect this relationship has been obscured by the variance of the measurement process or that the range of values of x is inappropriate. A great deal of nonstatistical evidence and knowledge of the subject matter in the field is required to conclude that $\beta_1 = 0$.

2.4 INTERVAL ESTIMATION IN SIMPLE LINEAR REGRESSION

In this section we consider confidence interval estimation of the regression model parameters. We also discuss interval estimation of the mean response $E(y)$ for given values of x . The normality assumptions introduced in Section 2.3 continue to apply.

2.4.1 Confidence Intervals on β_0 , β_1 , and σ^2

In addition to point estimates of β_0 , β_1 , and σ^2 , we may also obtain confidence interval estimates of these parameters. The width of these confidence intervals is a measure of the overall quality of the regression line. If the errors are normally and independently distributed, then the sampling distribution of both $(\hat{\beta}_1 - \beta_1)/\text{se}(\hat{\beta}_1)$ and $(\hat{\beta}_0 - \beta_0)/\text{se}(\hat{\beta}_0)$ is t with $n - 2$ degrees of freedom. Therefore, a $100(1 - \alpha)$ percent confidence interval (CI) on the slope β_1 is given by

$$\hat{\beta}_1 - t_{\alpha/2, n-2} \text{se}(\hat{\beta}_1) \leq \beta_1 \leq \hat{\beta}_1 + t_{\alpha/2, n-2} \text{se}(\hat{\beta}_1) \quad (2.39)$$

and a $100(1 - \alpha)$ percent CI on the intercept β_0 is

$$\hat{\beta}_0 - t_{\alpha/2, n-2} \text{se}(\hat{\beta}_0) \leq \beta_0 \leq \hat{\beta}_0 + t_{\alpha/2, n-2} \text{se}(\hat{\beta}_0) \quad (2.40)$$

These CIs have the usual frequentist interpretation. That is, if we were to take repeated samples of the same size at the same x levels and construct, for example, 95% CIs on the slope for each sample, then 95% of those intervals will contain the true value of β_1 .

If the errors are normally and independently distributed, Appendix C.3 shows that the sampling distribution of $(n - 2)MS_{\text{Res}}/\sigma^2$ is chi square with $n - 2$ degrees of freedom. Thus,

$$P\left\{\chi_{1-\alpha/2, n-2}^2 \leq \frac{(n-2)MS_{\text{Res}}}{\sigma^2} \leq \chi_{\alpha/2, n-2}^2\right\} = 1 - \alpha$$

and consequently a $100(1 - \alpha)$ percent CI on σ^2 is

$$\frac{(n-2)MS_{\text{Res}}}{\chi_{\alpha/2, n-2}^2} \leq \sigma^2 \leq \frac{(n-2)MS_{\text{Res}}}{\chi_{1-\alpha/2, n-2}^2} \quad (2.41)$$

Example 2.5 The Rocket Propellant Data

We construct 95% CIs on β_1 and σ^2 using the rocket propellant data from Example 2.1. The standard error of $\hat{\beta}_1$ is $\text{se}(\hat{\beta}_1) = 2.89$ and $t_{0.025, 18} = 2.101$. Therefore, from Eq. (2.35), the 95% CI on the slope is

$$\begin{aligned} \hat{\beta}_1 - t_{0.025, 18} \text{se}(\hat{\beta}_1) \leq \beta_1 \leq \hat{\beta}_1 + t_{0.025, 18} \text{se}(\hat{\beta}_1) \\ -37.15 - (2.101)(2.89) \leq \beta_1 \leq -37.15 + (2.101)(2.89) \end{aligned}$$

or

$$-43.22 \leq \beta_1 \leq -31.08$$

In other words, 95% of such intervals will include the true value of the slope.

If we had chosen a different value for α , the width of the resulting CI would have been different. For example, the 90% CI on β_1 is $-42.16 \leq \beta_1 \leq -32.14$, which is narrower than the 95% CI. The 99% CI is $-45.49 \leq \beta_1 \leq -28.81$, which is wider than the 95% CI. In general, the larger the confidence coefficient $(1 - \alpha)$ is, the wider the CI.

The 95% CI on σ^2 is found from Eq. (2.41) as follows:

$$\begin{aligned} \frac{(n-2)MS_{\text{Res}}}{\chi_{0.025, n-2}^2} \leq \sigma^2 \leq \frac{(n-2)MS_{\text{Res}}}{\chi_{0.975, n-2}^2} \\ \frac{18(9244.59)}{\chi_{0.025, 18}^2} \leq \sigma^2 \leq \frac{18(9244.59)}{\chi_{0.975, 18}^2} \end{aligned}$$

From Table A.2, $\chi_{0.025, 18}^2 = 31.5$ and $\chi_{0.975, 18}^2 = 8.23$. Therefore, the desired CI becomes

$$\frac{18(9244.59)}{31.5} \leq \sigma^2 \leq \frac{18(9244.59)}{8.23}$$

or

$$5282.62 \leq \sigma^2 \leq 20,219.03 \quad \blacksquare$$

2.4.2 Interval Estimation of the Mean Response

A major use of a regression model is to estimate the mean response $E(y)$ for a particular value of the regressor variable x . For example, we might wish to estimate the mean shear strength of the propellant bond in a rocket motor made from a batch of sustainer propellant that is 10 weeks old. Let x_0 be the level of the regressor variable for which we wish to estimate the mean response, say $E(y|x_0)$. We assume that

x_0 is any value of the regressor variable within the range of the original data on x used to fit the model. An unbiased point estimator of $E(y|x_0)$ is found from the fitted model as

$$\widehat{E}(y|x_0) = \hat{\mu}_{y|x_0} = \hat{\beta}_0 + \hat{\beta}_1 x_0 \quad (2.42)$$

To obtain a $100(1 - \alpha)$ percent CI on $E(y|x_0)$, first note that $\hat{\mu}_{y|x_0}$ is a normally distributed random variable because it is a linear combination of the observations y_i . The variance of $\hat{\mu}_{y|x_0}$ is

$$\begin{aligned} \text{Var}(\hat{\mu}_{y|x_0}) &= \text{Var}(\hat{\beta}_0 + \hat{\beta}_1 x_0) = \text{Var}\left[\bar{y} + \hat{\beta}_1(x_0 - \bar{x})\right] \\ &= \frac{\sigma^2}{n} + \frac{\sigma^2(x_0 - \bar{x})^2}{S_{xx}} = \sigma^2 \left[\frac{1}{n} + \frac{(x_0 - \bar{x})^2}{S_{xx}} \right] \end{aligned}$$

since (as noted in Section 2.2.4) $\text{Cov}(\bar{y}, \hat{\beta}_1) = 0$. Thus, the sampling distribution of

$$\frac{\hat{\mu}_{y|x_0} - E(y|x_0)}{\sqrt{MS_{\text{Res}}(1/n + (x_0 - \bar{x})^2/S_{xx})}}$$

is t with $n - 2$ degrees of freedom. Consequently, a **100(1 - α) percent CI on the mean response at the point $x = x_0$** is

$$\begin{aligned} \hat{\mu}_{y|x_0} - t_{\alpha/2, n-2} \sqrt{MS_{\text{Res}} \left(\frac{1}{n} + \frac{(x_0 - \bar{x})^2}{S_{xx}} \right)} \\ \leq E(y|x_0) \leq \hat{\mu}_{y|x_0} + t_{\alpha/2, n-2} \sqrt{MS_{\text{Res}} \left(\frac{1}{n} + \frac{(x_0 - \bar{x})^2}{S_{xx}} \right)} \end{aligned} \quad (2.43)$$

Note that the width of the CI for $E(y|x_0)$ is a function of x_0 . The interval width is a minimum for $x_0 = \bar{x}$ and widens as $|x_0 - \bar{x}|$ increases. Intuitively this is reasonable, as we would expect our best estimates of y to be made at x values near the center of the data and the precision of estimation to deteriorate as we move to the boundary of the x space.

Example 2.6 The Rocket Propellant Data

Consider finding a 95% CI on $E(y|x_0)$ for the rocket propellant data in Example 2.1. The CI is found from Eq. (2.43) as

$$\begin{aligned} \hat{\mu}_{y|x_0} - t_{\alpha/2, n-2} \sqrt{MS_{\text{Res}} \left(\frac{1}{n} + \frac{(x_0 - \bar{x})^2}{S_{xx}} \right)} \\ \leq E(y|x_0) \leq \hat{\mu}_{y|x_0} + t_{\alpha/2, n-2} \sqrt{MS_{\text{Res}} \left(\frac{1}{n} + \frac{(x_0 - \bar{x})^2}{S_{xx}} \right)} \end{aligned}$$

$$\hat{\mu}_{y|x_0} - (2.101)\sqrt{9244.59\left(\frac{1}{20} + \frac{(x_0 - 13.3625)^2}{1106.56}\right)}$$

$$\leq E(y|x_0) \leq \hat{\mu}_{y|x_0} + (2.101)\sqrt{9244.59\left(\frac{1}{20} + \frac{(x_0 - 13.3625)^2}{1106.56}\right)}$$

If we substitute values of x_0 and the fitted value $\hat{y}_0 = \hat{\mu}_{y|x_0}$ at the value of x_0 into this last equation, we will obtain the 95% CI on the mean response at $x = x_0$. For example, if $x_0 = \bar{x} = 13.3625$, then $\hat{\mu}_{y|x_0} = 2131.40$, and the CI becomes

$$2086.230 \leq E(y|13.3625) \leq 2176.571$$

Table 2.6 contains the 95% confidence limits on $E(y|x_0)$ for several other values of x_0 . These confidence limits are illustrated graphically in Figure 2.4. Note that the width of the CI increases as $|x_0 - \bar{x}|$ increases. ■

TABLE 2.6 Confidence Limits on $E(y|x_0)$ for Several Values of x_0

Lower Confidence Limit	x_0	Upper Confidence Limit
2438.919	3	2593.821
2341.360	6	2468.481
2241.104	9	2345.836
2136.098	12	2227.942
2086.230	$\bar{x} = 13.3625$	2176.571
2024.318	15	2116.822
1905.890	18	2012.351
1782.928	21	1912.412
1657.395	24	1815.045

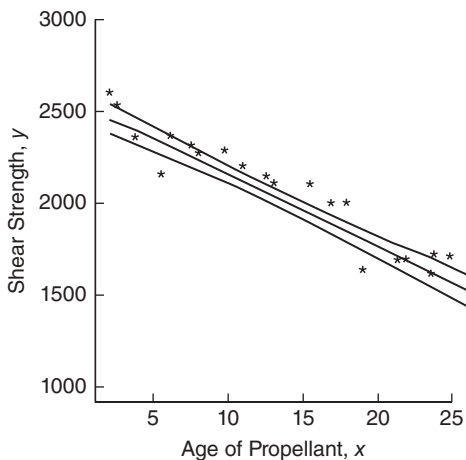

Figure 2.4 The upper and lower 95% confidence limits for the propellant data.

Many regression textbooks state that one should never use a regression model to **extrapolate** beyond the range of the original data. By extrapolation, we mean using the prediction equation beyond the boundary of the x space. Figure 1.5 illustrates clearly the dangers inherent in extrapolation; model or equation error can severely damage the prediction.

Equation (2.43) points out that the issue of extrapolation is much more subtle; the further the x value is from the center of the data, the more variable our estimate of $E(y|x_0)$. Please note, however, that nothing “magical” occurs at the boundary of the x space. It is not reasonable to think that the prediction is wonderful at the observed data value most remote from the center of the data and completely awful just beyond it. Clearly, Eq. (2.43) points out that we should be concerned about prediction quality as we approach the boundary and that as we move beyond this boundary, the prediction may deteriorate rapidly. Furthermore, the farther we move away from the original region of x space, the more likely it is that equation or model error will play a role in the process.

This is not the same thing as saying “never extrapolate.” Engineers and economists routinely use prediction equations to forecast a variable of interest one or more time periods in the future. Strictly speaking, this forecast is an extrapolation. Equation (2.43) supports such use of the prediction equation. However, Eq. (2.43) does not support using the regression model to forecast many periods in the future. Generally, the greater the extrapolation, the higher is the chance of equation error or model error impacting the results.

The probability statement associated with the CI (2.43) holds only when a single CI on the mean response is to be constructed. A procedure for constructing several CIs that, considered jointly, have a specified confidence level is a **simultaneous statistical inference** problem. These problems are discussed in Chapter 3.

2.5 PREDICTION OF NEW OBSERVATIONS

An important application of the regression model is prediction of new observations y corresponding to a specified level of the regressor variable x . If x_0 is the value of the regressor variable of interest, then

$$\hat{y}_0 = \hat{\beta}_0 + \hat{\beta}_1 x_0 \quad (2.44)$$

is the point estimate of the new value of the response y_0 .

Now consider obtaining an interval estimate of this future observation y_0 . The CI on the mean response at $x = x_0$ [Eq. (2.43)] is inappropriate for this problem because it is an interval estimate on the **mean** of y (a parameter), not a probability statement about future observations from that distribution. We now develop a **prediction interval for the future observation y_0** .

Note that the random variable

$$\psi = y_0 - \hat{y}_0$$

is normally distributed with mean zero and variance

$$\text{Var}(\psi) = \text{Var}(y_0 - \hat{y}_0) = \sigma^2 \left[1 + \frac{1}{n} + \frac{(x_0 - \bar{x})^2}{S_{xx}} \right]$$

because the future observation y_0 is independent of \hat{y}_0 . If we use \hat{y}_0 to predict y_0 , then the standard error of $\psi = y_0 - \hat{y}_0$ is the appropriate statistic on which to base a prediction interval. Thus, the $100(1 - \alpha)$ percent prediction interval on a future observation at x_0 is

$$\begin{aligned} \hat{y}_0 - t_{\alpha/2, n-2} \sqrt{MS_{\text{Res}} \left(1 + \frac{1}{n} + \frac{(x_0 - \bar{x})^2}{S_{xx}} \right)} \\ \leq y_0 \leq \hat{y}_0 + t_{\alpha/2, n-2} \sqrt{MS_{\text{Res}} \left(1 + \frac{1}{n} + \frac{(x_0 - \bar{x})^2}{S_{xx}} \right)} \end{aligned} \quad (2.45)$$

The prediction interval (2.45) is of minimum width at $x_0 = \bar{x}$ and widens as $|x_0 - \bar{x}|$ increases. By comparing (2.45) with (2.43), we observe that the prediction interval at x_0 is always wider than the CI at x_0 because the prediction interval depends on both the error from the fitted model and the error associated with future observations.

Example 2.7 The Rocket Propellant Data

We find a 95% prediction interval on a future value of propellant shear strength in a motor made from a batch of sustainer propellant that is 10 weeks old. Using (2.45), we find that the prediction interval is

$$\begin{aligned} \hat{y}_0 - t_{\alpha/2, n-2} \sqrt{MS_{\text{Res}} \left(1 + \frac{1}{n} + \frac{(x_0 - \bar{x})^2}{S_{xx}} \right)} \\ \leq y_0 \leq \hat{y}_0 + t_{\alpha/2, n-2} \sqrt{MS_{\text{Res}} \left(1 + \frac{1}{n} + \frac{(x_0 - \bar{x})^2}{S_{xx}} \right)} \\ 2256.32 - (2.101) \sqrt{9244.59 \left(1 + \frac{1}{20} + \frac{(10 - 13.3625)^2}{1106.56} \right)} \\ \leq y_0 \leq 2256.32 + (2.101) \sqrt{9244.59 \left(1 + \frac{1}{20} + \frac{(10 - 13.3625)^2}{1106.56} \right)} \end{aligned}$$

which simplifies to

$$2048.32 \leq y_0 \leq 2464.32$$

Therefore, a new motor made from a batch of 10-week-old sustainer propellant could reasonably be expected to have a propellant shear strength between 2048.32 and 2464.32 psi.

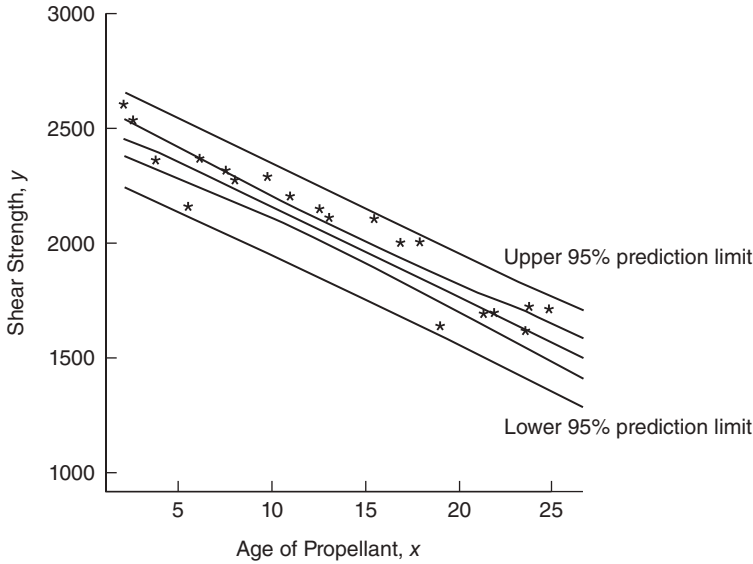

Figure 2.5 The 95% confidence and prediction intervals for the propellant data.

Figure 2.5 shows the 95% prediction interval calculated from (2.45) for the rocket propellant regression model. Also shown on this graph is the 95% CI on the mean [that is, $E(y|x)$ from Eq. (2.43)]. This graph nicely illustrates the point that the prediction interval is wider than the corresponding CI. ■

We may generalize (2.45) somewhat to find a $100(1 - \alpha)$ percent prediction interval on the **mean** of m future observations on the response at $x = x_0$. Let \bar{y}_0 be the mean of m future observations at $x = x_0$. A point estimator of \bar{y}_0 is $\hat{y}_0 = \hat{\beta}_0 + \hat{\beta}_1 x_0$. The $100(1 - \alpha)\%$ prediction interval on \bar{y}_0 is

$$\begin{aligned} & \hat{y}_0 - t_{\alpha/2, n-2} \sqrt{MS_{\text{Res}} \left(\frac{1}{m} + \frac{1}{n} + \frac{(x_0 - \bar{x})^2}{S_{xx}} \right)} \\ & \leq y_0 \leq \hat{y}_0 + t_{\alpha/2, n-2} \sqrt{MS_{\text{Res}} \left(\frac{1}{m} + \frac{1}{n} + \frac{(x_0 - \bar{x})^2}{S_{xx}} \right)} \end{aligned} \tag{2.46}$$

2.6 COEFFICIENT OF DETERMINATION

The quantity

$$R^2 = \frac{SS_R}{SS_T} = 1 - \frac{SS_{\text{Res}}}{SS_T} \tag{2.47}$$

is called the **coefficient of determination**. Since SS_T is a measure of the variability in y without considering the effect of the regressor variable x and SS_{Res} is a measure

of the variability in y remaining after x has been considered, R^2 is often called the proportion of variation explained by the regressor x . Because $0 \leq SS_{\text{Res}} \leq SS_{\text{T}}$, it follows that $0 \leq R^2 \leq 1$. Values of R^2 that are close to 1 imply that most of the variability in y is explained by the regression model. For the regression model for the rocket propellant data in Example 2.1, we have

$$R^2 = \frac{SS_{\text{R}}}{SS_{\text{T}}} = \frac{1,527,334.95}{1,693,737.60} = 0.9018$$

that is, 90.18% of the variability in strength is accounted for by the regression model.

The statistic R^2 should be used with caution, since it is always possible to make R^2 large by adding enough terms to the model. For example, if there are no repeat points (more than one y value at the same x value), a polynomial of degree $n - 1$ will give a “perfect” fit ($R^2 = 1$) to n data points. When there are repeat points, R^2 can never be exactly equal to 1 because the model cannot explain the variability related to “pure” error.

Although R^2 cannot decrease if we add a regressor variable to the model, this does not necessarily mean the new model is superior to the old one. Unless the error sum of squares in the new model is reduced by an amount equal to the original error mean square, the new model will have a larger error mean square than the old one because of the loss of one degree of freedom for error. Thus, the new model will actually be worse than the old one.

The magnitude of R^2 also depends on the range of variability in the regressor variable. Generally R^2 will increase as the spread of the x 's increases and decrease as the spread of the x 's decreases provided the assumed model form is correct. By the delta method (also see Hahn 1973), one can show that the expected value of R^2 from a straight-line regression is approximately

$$E(R^2) \approx \frac{\beta_1^2 S_{xx} / n - 1}{\frac{\beta_1^2 S_{xx}}{n - 1} + \sigma^2}$$

Clearly the expected value of R^2 will increase (decrease) as S_{xx} (a measure of the spread of the x 's) increases (decreases). Thus, a large value of R^2 may result simply because x has been varied over an unrealistically large range. On the other hand, R^2 may be small because the range of x was too small to allow its relationship with y to be detected.

There are several other misconceptions about R^2 . In general, R^2 does not measure the magnitude of the slope of the regression line. A large value of R^2 does not imply a steep slope. Furthermore, R^2 does not measure the appropriateness of the linear model, for R^2 will often be large even though y and x are nonlinearly related. For example, R^2 for the regression equation in Figure 2.3b will be relatively large even though the linear approximation is poor. Remember that although R^2 is large, this does not necessarily imply that the regression model will be an accurate predictor.

2.7 A SERVICE INDUSTRY APPLICATION OF REGRESSION

A hospital is implementing a program to improve service quality and productivity. As part of this program the hospital management is attempting to measure and evaluate patient satisfaction. Table B.17 contains some of the data that have been collected on a random sample of 25 recently discharged patients. The response variable is satisfaction, a subjective response measure on an increasing scale. The potential regressor variables are patient age, severity (an index measuring the severity of the patient's illness), an indicator of whether the patient is a surgical or medical patient (0 = surgical, 1 = medical), and an index measuring the patient's anxiety level. We start by building a simple linear regression model relating the response variable satisfaction to severity.

Figure 2.6 is a scatter diagram of satisfaction versus severity. There is a relatively mild indication of a potential linear relationship between these two variables. The output from JMP for fitting a simple linear regression model to these data is shown in Figure 2.7. JMP is an SAS product that is a menu-based PC statistics package with an extensive array of regression modeling and analysis capabilities.

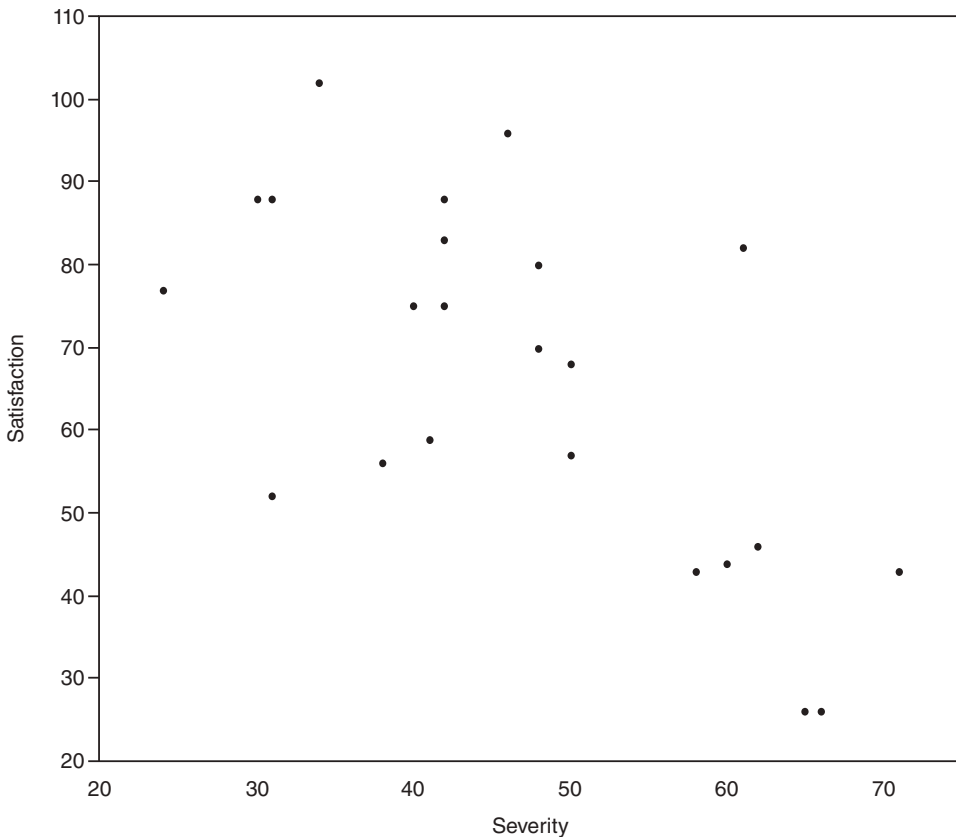
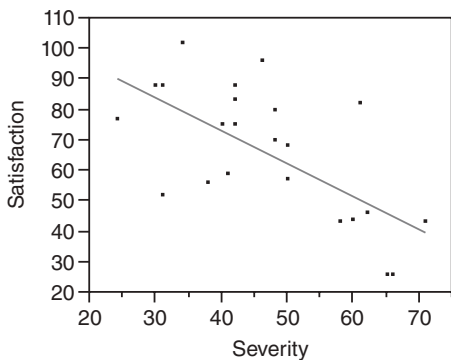
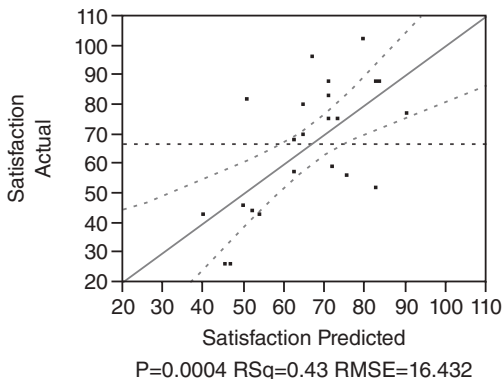

Figure 2.6 Scatter diagram of satisfaction versus severity.

**Response Satisfaction
Whole Model
Regression Plot**



Actual by Predicted Plot



Summary of Fit

RSquare	0.426596
RSquare Adj	0.401666
Root Mean Square Error	16.43242
Mean of Response	66.72
Observations (or Sum Wgts)	25

Analysis of Variance

Source	DF	Sum of Squares	Mean Square	F Ratio
Model	1	4620.482	4620.48	17.1114
Error	23	6210.558	270.02	Prob > F
C. Total	24	10831.040		0.0004*

Parameter Estimates

Term	Estimate	Std Error	t Ratio	Prob> t
Intercept	115.6239	12.27059	9.42	<.0001*

Figure 2.7 JMP output for the simple linear regression model for the patient satisfaction data.

At the top of the JMP output is the scatter plot of the satisfaction and severity data, along with the fitted regression line. The straight line fit looks reasonable although there is considerable variability in the observations around the regression line. The second plot is a graph of the actual satisfaction response versus the predicted response. If the model were a perfect fit to the data all of the points in this plot would lie exactly along the 45-degree line. Clearly, this model does not provide a perfect fit. Also, notice that while the regressor variable is significant (the ANOVA F statistic is 17.1114 with a P value that is less than 0.0004), the coefficient of determination $R^2 = 0.43$. That is, the model only accounts for about 43% of the variability in the data. It can be shown by the methods discussed in Chapter 4 that there are no fundamental problems with the underlying assumptions or measures of model adequacy, other than the rather low value of R^2 .

Low values for R^2 occur occasionally in practice. The model is significant, there are no obvious problems with assumptions or other indications of model inadequacy, but the proportion of variability explained by the model is low. Now this is not an entirely disastrous situation. There are many situations where explaining 30 to 40% of the variability in y with a single predictor provides information of considerable value to the analyst. Sometimes, a low value of R^2 results from having a lot of variability in the measurements of the response due to perhaps the type of measuring instrument being used, or the skill of the person making the measurements. Here the variability in the response probably arises because the response is an expression of opinion, which can be very subjective. Also, the measurements are taken on human patients, and there can be considerable variability both within people and between people. Sometimes, a low value of R^2 is a result of a poorly specified model. In these cases the model can often be improved by the addition of one or more predictor or regressor variables. We see in Chapter 3 that the addition of another regressor results in considerable improvement of this model.

2.8 USING SAS® AND R FOR SIMPLE LINEAR REGRESSION

The purpose of this section is to introduce readers to SAS and to R. Appendix D gives more details about using SAS, including how to import data from both text and EXCEL files. Appendix E introduces the R statistical software package. R is becoming increasingly popular since it is free over the Internet.

Table 2.7 gives the SAS source code to analyze the rocket propellant data that we have been analyzing throughout this chapter. Appendix D provides detail explaining how to enter the data into SAS. The statement PROC REG tells the software that we wish to perform an ordinary least-squares linear regression analysis. The “model” statement specifies the specific model and tells the software which analyses to perform. The variable name to the left of the equal sign is the response. The variables to the right of the equal sign but before the solidus are the regressors. The information after the solidus specifies additional analyses. By default, SAS prints the analysis-of-variance table and the tests on the individual coefficients. In this case, we have specified three options: “p” asks SAS to print the predicted values, “clm” (which stands for confidence limit, mean) asks SAS to print the confidence band, and “cli” (which stands for confidence limit, individual observations) asks SAS to print the prediction band.

TABLE 2.7 SAS Code for Rocket Propellant Data

```

data rocket;
input shear age;
cards;
2158.70 15.50
1678.15 23.75
2316.00 8.00
2061.30 17.00
2207.50 5.50
1708.30 19.00
1784.70 24.00
2575.00 2.50
2357.90 7.50
2256.70 11.00
2165.20 13.00
2399.55 3.75
1779.80 25.99
2336.75 9.75
1765.30 22.00
2053.50 18.00
2414.40 6.00
2200.50 12.50
2654.20 2.00
1753.70 21.50
proc reg;
model shear=age/p clm cli;
run;

```

Table 2.8 gives the SAS output for this analysis. PROC REG always produces the analysis-of-variance table and the information on the parameter estimates. The “p clm cli” options on the model statement produced the remainder of the output file.

SAS also produces a log file that provides a brief summary of the SAS session. The log file is almost essential for debugging SAS code. Appendix D provides more details about this file.

R is a popular statistical software package, primarily because it is freely available at www.r-project.org. An easier-to-use version of R is R Commander. R itself is a high-level programming language. Most of its commands are prewritten functions. It does have the ability to run loops and call other routines, for example, in C. Since it is primarily a programming language, it often presents challenges to novice users. The purpose of this section is to introduce the reader as to how to use R to analyze simple linear regression data sets.

The first step is to create the data set. The easiest way is to input the data into a text file using spaces for delimiters. Each row of the data file is a record. The top row should give the names for each variable. All other rows are the actual data records. For example, consider the rocket propellant data from Example 2.1 given in Table 2.1. Let propellant.txt be the name of the data file. The first row of the text file gives the variable names:

TABLE 2.8 SAS Output for Analysis of Rocket Propellant Data.

SAS system 1								
The REG Procedure								
Model: MODEL1								
Dependent Variable: shear								
Number of Observations Read						20		
Number of Observations Used						20		
Analysis of Variance								
Source	DF	Sum of Squares	Mean Square	F Value	Pr > F			
Model	1	1527483	1527483	165.38	<.0001			
Error	18	166255	9236.38100					
Corrected Total	19	1693738						
Root MSE	96.10609	R- square	0.9018					
Dependent Mean	2131.35750	Adj R- Sq	0.8964					
Coeff Var	4.50915							
Parameter Estimates								
Variable	DF	Parameter Estimate	Standard Error	t value	Pr > t			
Intercept	1	2627.82236	44.18391	59.47	<.0001			
age	1	-37.15359	2.88911	-12.86	<.0001			
The SAS System 2								
The REG Procedure								
Model: MODEL1								
Dependent Variable: shear								
Output Statistics								
Obs	Dependent Variable	Predicted Value	Std Error Mean Predict	95% CL	Mean	95% CL	Predict	Residual
1	2159	2052	22.3597	2005	2099	1845	2259	106.7583
2	1678	1745	36.9114	1668	1823	1529	1962	-67.2746
3	2316	2331	26.4924	2275	2386	2121	2540	-14.5936
4	2061	1996	23.9220	1946	2046	1788	2204	65.0887
5	2208	2423	31.2701	2358	2489	2211	2636	-215.9776
6	1708	1922	26.9647	1865	1979	1712	2132	-213.6041
7	1785	1736	37.5010	1657	1815	1519	1953	48.5638
8	2575	2535	38.0356	2455	2615	2318	2752	40.0616
9	2358	2349	27.3623	2292	2407	2139	2559	8.7296
10	2257	2219	22.5479	2172	2267	2012	2427	37.5671
11	2165	2145	21.5155	2100	2190	1938	2352	20.3743
12	2400	2488	35.1152	2415	2562	2274	2703	-88.9464
13	1780	1699	39.9031	1615	1783	1480	1918	80.8174
14	2337	2266	23.8903	2215	2316	2058	2474	71.1752
15	1765	1810	32.9362	1741	1880	1597	2024	-45.1434
16	2054	1959	25.3245	1906	2012	1750	2168	94.4423
17	2414	2405	30.2370	2341	2468	2193	2617	9.4992
18	2201	2163	21.6340	2118	2209	1956	2370	37.0975
19	2654	2554	39.2360	2471	2636	2335	2772	100.6848
20	1754	1829	31.8519	1762	1896	1616	2042	-75.3202
Sum of Residuals						0		
Sum of squared Residuals						166255		
Predicted Residual SS (PRESS)						205944		

```
strength age
```

The next row is the first data record, with spaces delimiting each data item:

```
2158.70 15.50
```

The R code to read the data into the package is:

```
prop <- read.table("propellant.txt", header=TRUE, sep=" ")
```

The object `prop` is the R data set, and “`propellant.txt`” is the original data file. The phrase, `header=TRUE` tells R that the first row is the variable names. The phrase `sep=" "` tells R that the data are space delimited.

The commands

```
prop.model <- lm(strength~age, data=prop)
summary(prop.model)
```

tell R

- to estimate the model, and
- to print the analysis of variance, the estimated coefficients, and their tests.

R Commander is an add-on package to R. It also is freely available. It provides an easy-to-use user interface, much like Minitab and JMP, to the parent R product. R Commander makes it much more convenient to use R; however, it does not provide much flexibility in its analysis. R Commander is a good way for users to get familiar with R. Ultimately, however, we recommend the use of the parent R product.

2.9 SOME CONSIDERATIONS IN THE USE OF REGRESSION

Regression analysis is widely used and, unfortunately, frequently misused. There are several common abuses of regression that should be mentioned:

1. Regression models are intended as interpolation equations over the range of the regressor variable(s) used to fit the model. As observed previously, we must be careful if we extrapolate outside of this range. Refer to Figure 1.5.
2. The disposition of the x values plays an important role in the least-squares fit. While all points have equal weight in determining the height of the line, the slope is more strongly influenced by the remote values of x . For example, consider the data in Figure 2.8. The slope in the least-squares fit depends heavily on either or both of the points A and B . Furthermore, the remaining data would give a very different estimate of the slope if A and B were deleted. Situations

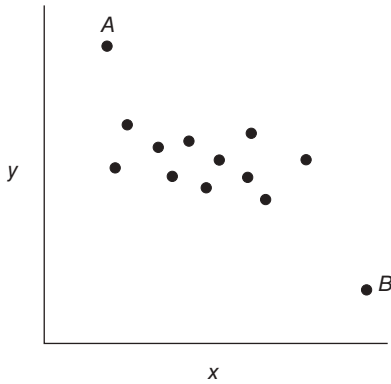

Figure 2.8 Two influential observations.

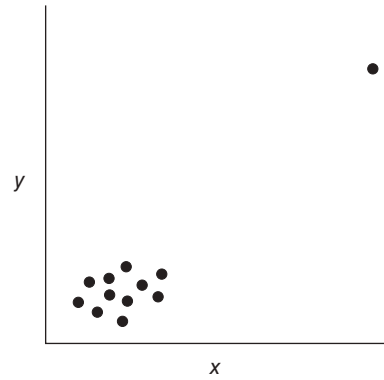

Figure 2.9 A point remote in x space.

such as this often require corrective action, such as further analysis and possible deletion of the unusual points, estimation of the model parameters with some technique that is less seriously influenced by these points than least squares, or restructuring the model, possibly by introducing further regressors.

A somewhat different situation is illustrated in Figure 2.9, where one of the 12 observations is very remote in x space. In this example the slope is largely determined by the extreme point. If this point is deleted, the slope estimate is probably zero. Because of the gap between the two clusters of points, we really have only two distinct information units with which to fit the model. Thus, there are effectively far fewer than the apparent 10 degrees of freedom for error.

Situations such as these seem to occur fairly often in practice. In general we should be aware that in some data sets one point (or a small cluster of points) may control key model properties.

3. **Outliers** are observations that differ considerably from the rest of the data. They can seriously disturb the least-squares fit. For example, consider the data in Figure 2.10. Observation *A* seems to be an outlier because it falls far from the line implied by the rest of the data. If this point is really an outlier, then the estimate of the intercept may be incorrect and the residual mean square may be an inflated estimate of σ^2 . The outlier may be a “bad value” that has resulted from a data recording or some other error. On the other hand, the data point may not be a bad value and may be a highly useful piece of evidence concerning the process under investigation. Methods for detecting and dealing with outliers are discussed more completely in Chapter 4.
4. As mentioned in Chapter 1, just because a regression analysis has indicated a strong relationship between two variables, this does not imply that the variables are related in any causal sense. Causality implies necessary correlation. Regression analysis can only address the issues on correlation. It cannot address the issue of necessity. Thus, our expectations of discovering cause-and-effect relationships from regression should be modest.

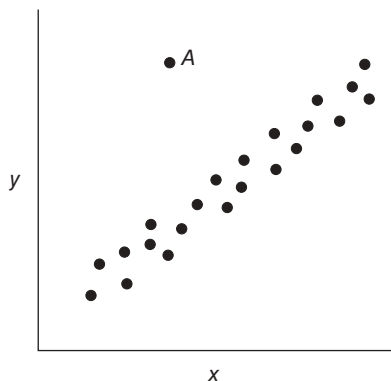

Figure 2.10 An outlier.

TABLE 2.9 Data Illustrating Nonsense Relationships between Variables

Year	Number of Certified Mental Defectives per 10,000 of Estimated Population in the U.K. (y)	Number of Radio Receiver Licenses Issued (Millions) in the U.K. (x_1)	First Name of the President of the U.S. (x_2)
1924	8	1.350	Calvin
1925	8	1.960	Calvin
1926	9	2.270	Calvin
1927	10	2.483	Calvin
1928	11	2.730	Calvin
1929	11	3.091	Calvin
1930	12	3.647	Herbert
1931	16	4.620	Herbert
1932	18	5.497	Herbert
1933	19	6.260	Herbert
1934	20	7.012	Franklin
1935	21	7.618	Franklin
1936	22	8.131	Franklin
1937	23	8.593	Franklin

Source: Kendall and Yule [1950] and Tufte [1974].

As an example of a “nonsense” relationship between two variables, consider the data in Table 2.9. This table presents the number of certified mental defectives in the United Kingdom per 10,000 of estimated population (y), the number of radio receiver licenses issued (x_1), and the first name of the President of the United States (x_2) for the years 1924–1937. We can show that the regression equation relating y to x_1 is

$$\hat{y} = 4.582 + 2.204x_1$$

The t statistic for testing $H_0: \beta_1 = 0$ for this model is $t_0 = 27.312$ (the P value is 3.58×10^{-12}), and the coefficient of determination is $R^2 = 0.9842$. That is, 98.42% of the variability in the data is explained by the number of radio

receiver licenses issued. Clearly this is a nonsense relationship, as it is highly unlikely that the number of mental defectives in the population is functionally related to the number of radio receiver licenses issued. The reason for this strong statistical relationship is that y and x_1 are monotonically related (two sequences of numbers are monotonically related if as one sequence increases, the other always either increases or decreases). In this example y is increasing because diagnostic procedures for mental disorders are becoming more refined over the years represented in the study and x_1 is increasing because of the emergence and low-cost availability of radio technology over the years.

Any two sequences of numbers that are monotonically related will exhibit similar properties. To illustrate this further, suppose we regress y on the number of letters in the first name of the U.S. president in the corresponding year. The model is

$$\hat{y} = -26.442 + 5.900x_2$$

with $t_0 = 8.996$ (the P value is 1.11×10^{-6}) and $R^2 = 0.8709$. Clearly this is a nonsense relationship as well.

5. In some applications of regression the value of the regressor variable x required to predict y is unknown. For example, consider predicting maximum daily load on an electric power generation system from a regression model relating the load to the maximum daily temperature. To predict tomorrow's maximum load, we must first predict tomorrow's maximum temperature. Consequently, the prediction of maximum load is **conditional** on the temperature forecast. The accuracy of the maximum load forecast depends on the accuracy of the temperature forecast. This must be considered when evaluating model performance.

Other abuses of regression are discussed in subsequent chapters. For further reading on this subject, see the article by Box [1966].

2.10 REGRESSION THROUGH THE ORIGIN

Some regression situations seem to imply that a straight line passing through the origin should be fit to the data. A **no-intercept regression model** often seems appropriate in analyzing data from chemical and other manufacturing processes. For example, the yield of a chemical process is zero when the process operating temperature is zero.

The no-intercept model is

$$y = \beta_1 x + \varepsilon \tag{2.48}$$

Given n observations (y_i, x_i) , $i = 1, 2, \dots, n$, the least-squares function is

$$S(\beta_1) = \sum_{i=1}^n (y_i - \beta_1 x_i)^2$$

The only normal equation is

$$\hat{\beta}_1 \sum_{i=1}^n x_i^2 = \sum_{i=1}^n y_i x_i \quad (2.49)$$

and the **least-squares estimator of the slope** is

$$\hat{\beta}_1 = \frac{\sum_{i=1}^n y_i x_i}{\sum_{i=1}^n x_i^2} \quad (2.50)$$

The estimator of $\hat{\beta}_1$ is unbiased for β_1 , and the **fitted regression model** is

$$\hat{y} = \hat{\beta}_1 x \quad (2.51)$$

The estimator of σ^2 is

$$\hat{\sigma}^2 = MS_{\text{Res}} = \frac{\sum_{i=1}^n (y_i - \hat{y}_i)^2}{n-1} = \frac{\sum_{i=1}^n y_i^2 - \hat{\beta}_1 \sum_{i=1}^n y_i x_i}{n-1} \quad (2.52)$$

with $n - 1$ degrees of freedom.

Making the normality assumption on the errors, we may test hypotheses and construct confidence and prediction intervals for the no-intercept model. The **100(1 - α) percent CI on β_1** is

$$\hat{\beta}_1 - t_{\alpha/2, n-1} \sqrt{\frac{MS_{\text{Res}}}{\sum_{i=1}^n x_i^2}} \leq \beta_1 \leq \hat{\beta}_1 + t_{\alpha/2, n-1} \sqrt{\frac{MS_{\text{Res}}}{\sum_{i=1}^n x_i^2}} \quad (2.53)$$

A **100(1 - α) percent CI on $E(y|x_0)$** , the mean response at $x = x_0$, is

$$\hat{\mu}_{y|x_0} - t_{\alpha/2, n-1} \sqrt{\frac{x_0^2 MS_{\text{Res}}}{\sum_{i=1}^n x_i^2}} \leq E(y|x_0) \leq \hat{\mu}_{y|x_0} + t_{\alpha/2, n-1} \sqrt{\frac{x_0^2 MS_{\text{Res}}}{\sum_{i=1}^n x_i^2}} \quad (2.54)$$

The **100(1 - α) percent prediction interval on a future observation at $x = x_0$** , say y_0 , is

$$\hat{y}_0 - t_{\alpha/2, n-1} \sqrt{MS_{\text{Res}} \left(1 + \frac{x_0^2}{\sum_{i=1}^n x_i^2} \right)} \leq y_0 \leq \hat{y}_0 + t_{\alpha/2, n-1} \sqrt{MS_{\text{Res}} \left(1 + \frac{x_0^2}{\sum_{i=1}^n x_i^2} \right)} \quad (2.55)$$

Both the CI (2.54) and the prediction interval (2.55) widen as x_0 increases. Furthermore, the length of the CI (2.54) at $x = 0$ is zero because the model assumes that the mean y at $x = 0$ is known with certainty to be zero. This behavior is considerably different than observed in the intercept model. The prediction interval (2.55) has nonzero length at $x_0 = 0$ because the random error in the future observation must be taken into account.

It is relatively easy to misuse the no-intercept model, particularly in situations where the data lie in a region of x space remote from the origin. For example, consider the no-intercept fit in the scatter diagram of chemical process yield (y) and operating temperature (x) in Figure 2.11a. Although over the range of the regressor variable $100^\circ\text{F} \leq x \leq 200^\circ\text{F}$, yield and temperature seem to be linearly related, forcing the model to go through the origin provides a visibly poor fit. A model containing an intercept, such as illustrated in Figure 2.11b, provides a much better fit in the region of x space where the data were collected.

Frequently the relationship between y and x is quite different near the origin than it is in the region of x space containing the data. This is illustrated in Figure 2.12 for the chemical process data. Here it would seem that either a quadratic or a more complex nonlinear regression model would be required to adequately express the relationship between y and x over the entire range of x . Such a model should only be entertained if the range of x in the data is sufficiently close to the origin.

The scatter diagram sometimes provides guidance in deciding whether or not to fit the no-intercept model. Alternatively we may fit both models and choose between them based on the quality of the fit. If the hypothesis $\beta_0 = 0$ cannot be rejected in the intercept model, this is an indication that the fit may be improved by using the

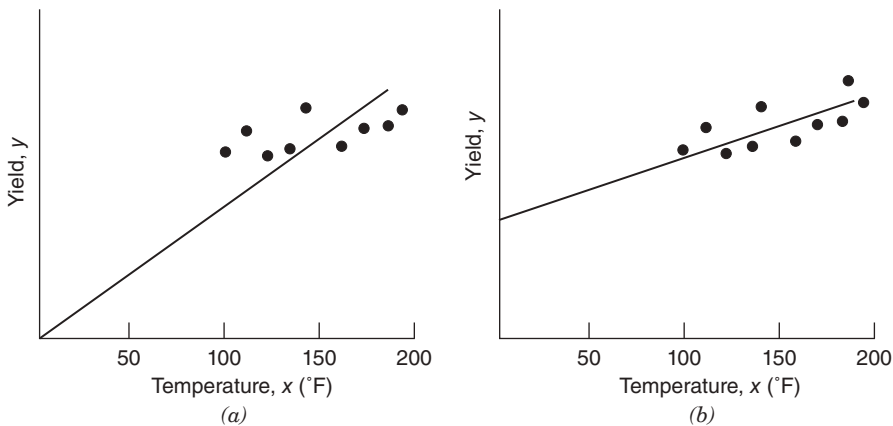

Figure 2.11 Scatter diagrams and regression lines for chemical process yield and operating temperature: (a) no-intercept model; (b) intercept model.

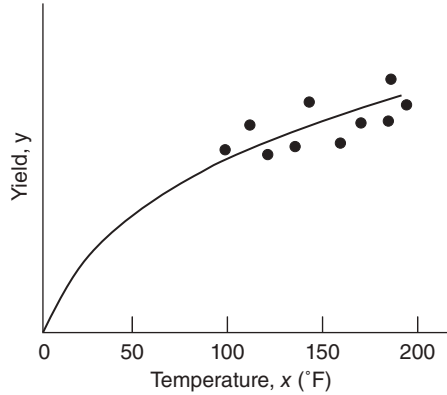

Figure 2.12 True relationship between yield and temperature.

no-intercept model. The residual mean square is a useful way to compare the quality of fit. The model having the smaller residual mean square is the best fit in the sense that it minimizes the estimate of the variance of y about the regression line.

Generally R^2 is not a good comparative statistic for the two models. For the intercept model we have

$$R^2 = \frac{\sum_{i=1}^n (\hat{y}_i - \bar{y})^2}{\sum_{i=1}^n (y_i - \bar{y})^2} = \frac{\text{variation in } y \text{ explained by regression}}{\text{total observed variation in } y}$$

Note that R^2 indicates the proportion of variability around \bar{y} explained by regression. In the no-intercept case the fundamental analysis-of-variance identity (2.32) becomes

$$\sum_{i=1}^n y_i^2 = \sum_{i=1}^n \hat{y}_i^2 + \sum_{i=1}^n (y_i - \hat{y}_i)^2$$

so that the no-intercept model analogue for R^2 would be

$$R_0^2 = \frac{\sum_{i=1}^n \hat{y}_i^2}{\sum_{i=1}^n y_i^2}$$

The statistic R_0^2 indicates the proportion of variability around the **origin** (zero) accounted for by regression. We occasionally find that R_0^2 is larger than R^2 even though the residual mean square (which is a reasonable measure of the overall quality of the fit) for the intercept model is smaller than the residual mean square

for the no-intercept model. This arises because R_0^2 is computed using uncorrected sums of squares.

There are alternative ways to define R^2 for the no-intercept model. One possibility is

$$R_0^2 = 1 - \frac{\sum_{i=1}^n (y_i - \hat{y}_i)^2}{\sum_{i=1}^n (y_i - \bar{y})^2}$$

However, in cases where $\sum_{i=1}^n (y_i - \hat{y}_i)^2$ is large, R_0^2 can be negative. We prefer to use MS_{Res} as a basis of comparison between intercept and no-intercept regression models. A nice article on regression models with no intercept term is Hahn [1979].

Example 2.8 The Shelf-Stocking Data

The time required for a merchandiser to stock a grocery store shelf with a soft drink product as well as the number of cases of product stocked is shown in Table 2.10. The scatter diagram shown in Figure 2.13 suggests that a straight line passing through the origin could be used to express the relationship between time and the number of cases stocked. Furthermore, since if the number of cases $x = 0$, then shelf stocking time $y = 0$, this model seems intuitively reasonable. Note also that the range of x is close to the origin.

The slope in the no-intercept model is computed from Eq. (2.50) as

$$\hat{\beta}_1 = \frac{\sum_{i=1}^n y_i x_i}{\sum_{i=1}^n x_i^2} = \frac{1841.98}{4575.00} = 0.4026$$

Therefore, the fitted equation is

$$\hat{y} = 0.4026x$$

This regression line is shown in Figure 2.14. The residual mean square for this model is $MS_{\text{Res}} = 0.0893$ and $R_0^2 = 0.9883$. Furthermore, the t statistic for testing $H_0: \beta_1 = 0$ is $t_0 = 91.13$, for which the P value is 8.02×10^{-21} . These summary statistics do not reveal any startling inadequacy in the no-intercept model. ■

We may also fit the intercept model to the data for comparative purposes. This results in

$$\hat{y} = -0.0938 + 0.4071x$$

The t statistic for testing $H_0: \beta_0 = 0$ is $t_0 = -0.65$, which is not significant, implying that the no-intercept model may provide a superior fit. The residual mean square

TABLE 2.10 Shelf-Stocking Data for Example 2.8

Times, y (minutes)	Cases Stocked, x
10.15	25
2.96	6
3.00	8
6.88	17
0.28	2
5.06	13
9.14	23
11.86	30
11.69	28
6.04	14
7.57	19
1.74	4
9.38	24
0.16	1
1.84	5

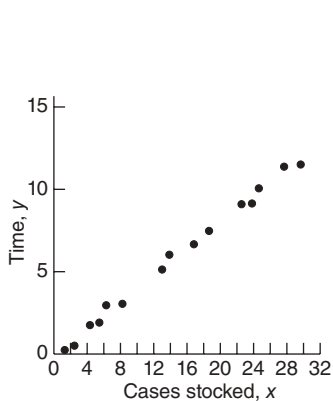

Figure 2.13 Scatter diagram of shelf-stocking data.

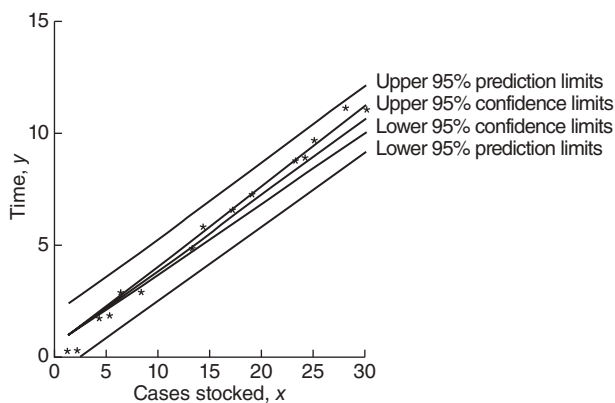

Figure 2.14 The confidence and prediction bands for the shelf-stocking data.

for the intercept model is $MS_{Res} = 0.0931$ and $R^2 = 0.9997$. Since MS_{Res} for the no-intercept model is smaller than MS_{Res} for the intercept model, we conclude that the no-intercept model is superior. As noted previously, the R^2 statistics are not directly comparable.

Figure 2.14 also shows the 95% confidence interval or $E(y|x_0)$ computed from Eq. (2.54) and the 95% prediction interval on a single future observation y_0 at $x = x_0$ computed from Eq. (2.55). Notice that the length of the confidence interval at $x_0 = 0$ is zero.

SAS handles the no-intercept case. For this situation, the model statement follows:

```
model time = cases/noint
```

2.11 ESTIMATION BY MAXIMUM LIKELIHOOD

The method of least squares can be used to estimate the parameters in a linear regression model regardless of the form of the distribution of the errors ϵ . Least squares produces best linear unbiased estimators of β_0 and β_1 . Other statistical procedures, such as hypothesis testing and CI construction, assume that the errors are normally distributed. If the form of the distribution of the errors is known, an alternative method of parameter estimation, the **method of maximum likelihood**, can be used.

Consider the data $(y_i, x_i), i = 1, 2, \dots, n$. If we assume that the errors in the regression model are $\text{NID}(0, \sigma^2)$, then the observations y_i in this sample are normally and independently distributed random variables with mean $\beta_0 + \beta_1 x_i$ and variance σ^2 . The likelihood function is found from the joint distribution of the observations. If we consider this joint distribution with the observations given and the parameters β_0, β_1 , and σ^2 unknown constants, we have the likelihood function. For the simple linear regression model with normal errors, the **likelihood function** is

$$\begin{aligned} L(y_i, x_i, \beta_0, \beta_1, \sigma^2) &= \prod_{i=1}^n (2\pi\sigma^2)^{-1/2} \exp\left[-\frac{1}{2\sigma^2} (y_i - \beta_0 - \beta_1 x_i)^2\right] \\ &= (2\pi\sigma^2)^{-n/2} \exp\left[-\frac{1}{2\sigma^2} \sum_{i=1}^n (y_i - \beta_0 - \beta_1 x_i)^2\right] \end{aligned} \quad (2.56)$$

The maximum-likelihood estimators are the parameter values, say $\tilde{\beta}_0, \tilde{\beta}_1$, and $\tilde{\sigma}^2$, that maximize L , or equivalently, $\ln L$. Thus,

$$\begin{aligned} \ln L(y_i, x_i, \beta_0, \beta_1, \sigma^2) &= -\left(\frac{n}{2}\right) \ln 2\pi - \left(\frac{n}{2}\right) \ln \sigma^2 \\ &= -\left(\frac{1}{2\sigma^2}\right) \sum_{i=1}^n (y_i - \beta_0 - \beta_1 x_i)^2 \end{aligned} \quad (2.57)$$

and the maximum-likelihood estimators $\tilde{\beta}_0, \tilde{\beta}_1$, and $\tilde{\sigma}^2$ must satisfy

$$\left. \frac{\partial \ln L}{\partial \beta_0} \right|_{\tilde{\beta}_0, \tilde{\beta}_1, \tilde{\sigma}^2} = \frac{1}{\tilde{\sigma}^2} \sum_{i=1}^n (y_i - \tilde{\beta}_0 - \tilde{\beta}_1 x_i) = 0 \quad (2.58a)$$

$$\left. \frac{\partial \ln L}{\partial \beta_1} \right|_{\tilde{\beta}_0, \tilde{\beta}_1, \tilde{\sigma}^2} = \frac{1}{\tilde{\sigma}^2} \sum_{i=1}^n (y_i - \tilde{\beta}_0 - \tilde{\beta}_1 x_i) x_i = 0 \quad (2.58b)$$

and

$$\left. \frac{\partial \ln L}{\partial \sigma^2} \right|_{\tilde{\beta}_0, \tilde{\beta}_1, \tilde{\sigma}^2} = -\frac{n}{2\tilde{\sigma}^2} + \frac{1}{2\tilde{\sigma}^4} \sum_{i=1}^n (y_i - \tilde{\beta}_0 - \tilde{\beta}_1 x_i)^2 = 0 \quad (2.58c)$$

The solution to Eq. (2.58) gives the **maximum-likelihood estimators**:

$$\tilde{\beta}_0 = \bar{y} - \tilde{\beta}_1 \bar{x} \quad (2.59a)$$

$$\tilde{\beta} = \frac{\sum_{i=1}^n y_i (x_i - \bar{x})}{\sum_{i=1}^n (x_i - \bar{x})^2} \quad (2.59b)$$

$$\tilde{\sigma}^2 = \frac{\sum_{i=1}^n (y_i - \tilde{\beta}_0 - \tilde{\beta}_1 x_i)^2}{n} \quad (2.59c)$$

Notice that the maximum-likelihood estimators of the intercept and slope, $\tilde{\beta}_0$ and $\tilde{\beta}_1$, are identical to the least-squares estimators of these parameters. Also, $\tilde{\sigma}^2$ is a biased estimator of σ^2 . The biased estimator is related to the unbiased estimator $\hat{\sigma}^2$ [Eq. (2.19)] by $\tilde{\sigma}^2 = [(n-1)/n]\hat{\sigma}^2$. The bias is small if n is moderately large. Generally the unbiased estimator $\hat{\sigma}^2$ is used.

In general, maximum-likelihood estimators have better **statistical properties** than least-squares estimators. The maximum-likelihood estimators are **unbiased** (including $\tilde{\sigma}^2$, which is **asymptotically unbiased**, or unbiased as n becomes large) and have **minimum variance** when compared to **all** other unbiased estimators. They are also **consistent estimators** (consistency is a large-sample property indicating that the estimators differ from the true parameter value by a very small amount as n becomes large), and they are a set of **sufficient statistics** (this implies that the estimators contain all of the “information” in the original sample of size n). On the other hand, maximum-likelihood estimation requires more stringent statistical assumptions than the least-squares estimators. The least-squares estimators require only second-moment assumptions (assumptions about the expected value, the variances, and the covariances among the random errors). The maximum-likelihood estimators require a full distributional assumption, in this case that the random errors follow a normal distribution with the same second moments as required for the least-squares estimates. For more information on maximum-likelihood estimation in regression models, see Graybill [1961, 1976], Myers [1990], Searle [1971], and Seber [1977].

2.12 CASE WHERE THE REGRESSOR x IS RANDOM

The linear regression model that we have presented in this chapter assumes that the values of the regressor variable x are known constants. This assumption makes the confidence coefficients and type I (or type II) errors refer to repeated sampling on y at the same x levels. There are many situations in which assuming that the x 's are fixed constants is inappropriate. For example, consider the soft drink delivery time data from Chapter 1 (Figure 1.1). Since the outlets visited by the delivery person are selected at random, it is unrealistic to believe that we can control the delivery volume x . It is more reasonable to assume that both y and x are random variables.

Fortunately, under certain circumstances, all of our earlier results on parameter estimation, testing, and prediction are valid. We now discuss these situations.

2.12.1 x and y Jointly Distributed

Suppose that x and y are jointly distributed random variables but the form of this joint distribution is unknown. It can be shown that all of our previous regression results hold if the following conditions are satisfied:

1. The conditional distribution of y given x is normal with conditional mean $\beta_0 + \beta_1 x$ and conditional variance σ^2 .
2. The x 's are independent random variables whose probability distribution does not involve β_0 , β_1 , and σ^2 .

While all of the regression procedures are unchanged when these conditions hold, the confidence coefficients and statistical errors have a different interpretation. When the regressor is a random variable, these quantities apply to repeated sampling of (x_i, y_i) values and not to repeated sampling of y_i at fixed levels of x_i .

2.12.2 x and y Jointly Normally Distributed: Correlation Model

Now suppose that y and x are jointly distributed according to the **bivariate normal distribution**. That is,

$$f(y, x) = \frac{1}{2\pi\sigma_1\sigma_2\sqrt{1-\rho^2}} \exp\left\{-\frac{1}{2(1-\rho^2)}\left[\left(\frac{y-\mu_1}{\sigma_1}\right)^2 + \left(\frac{x-\mu_2}{\sigma_2}\right)^2 - 2\rho\left(\frac{y-\mu_1}{\sigma_1}\right)\left(\frac{x-\mu_2}{\sigma_2}\right)\right]\right\} \quad (2.60)$$

where μ_1 and σ_1^2 the mean and variance of y , μ_2 and σ_2^2 the mean and variance of x , and

$$\rho = \frac{E(y-\mu_1)(x-\mu_2)}{\sigma_1\sigma_2} = \frac{\sigma_{12}}{\sigma_1\sigma_2}$$

is the **correlation coefficient** between y and x . The term σ_{12} is the **covariance** of y and x .

The **conditional distribution** of y for a given value of x is

$$f(y|x) = \frac{1}{\sqrt{2\pi}\sigma_{1.2}} \exp\left[-\frac{1}{2}\left(\frac{y-\beta_0-\beta_1x}{\sigma_{1.2}}\right)^2\right] \quad (2.61)$$

where

$$\beta_0 = \mu_1 - \mu_2\rho\frac{\sigma_1}{\sigma_2} \quad (2.62a)$$

$$\beta_1 = \frac{\sigma_1}{\sigma_2}\rho \quad (2.62b)$$

and

$$\sigma_{1.2}^2 = \sigma_1^2(1 - \rho^2) \quad (2.62c)$$

That is, the conditional distribution of y given x is normal with conditional mean

$$E(y|x) = \beta_0 + \beta_1 x \quad (2.63)$$

and conditional variance $\sigma_{1.2}^2$. Note that the mean of the conditional distribution of y given x is a straight-line regression model. Furthermore, there is a relationship between the correlation coefficient ρ and the slope β_1 . From Eq. (2.62b) we see that if $\rho = 0$, then $\beta_1 = 0$, which implies that there is no linear regression of y on x . That is, knowledge of x does not assist us in predicting y .

The method of maximum likelihood may be used to estimate the parameters β_0 and β_1 . It may be shown that the maximum-likelihood estimators of these parameters are

$$\hat{\beta}_0 = \bar{y} - \hat{\beta}_1 \bar{x} \quad (2.64a)$$

and

$$\hat{\beta}_1 = \frac{\sum_{i=1}^n y_i (x_i - \bar{x})}{\sum_{i=1}^n (x_i - \bar{x})^2} = \frac{S_{xy}}{S_{xx}} \quad (2.64b)$$

The estimators of the intercept and slope in Eq. (2.64) are identical to those given by the method of least squares in the case where x was assumed to be a controllable variable. In general, the regression model with y and x jointly normally distributed may be analyzed by the methods presented previously for the model with x a controllable variable. This follows because the random variable y given x is independently and normally distributed with mean $\beta_0 + \beta_1 x$ and constant variance $\sigma_{1.2}^2$. As noted in Section 2.12.1, these results will also hold for **any** joint distribution of y and x such that the conditional distribution of y given x is normal.

It is possible to draw inferences about the correlation coefficient ρ in this model. The estimator of ρ is the **sample correlation coefficient**

$$r = \frac{\sum_{i=1}^n y_i (x_i - \bar{x})}{\left[\sum_{i=1}^n (x_i - \bar{x})^2 \sum_{i=1}^n (y_i - \bar{y})^2 \right]^{1/2}} = \frac{S_{xy}}{[S_{xx} S_{yy}]^{1/2}} \quad (2.65)$$

Note that

$$\hat{\beta}_1 = \left(\frac{SS_T}{S_{xx}} \right)^{1/2} r \quad (2.66)$$

so that the slope $\hat{\beta}$ is just the sample correlation coefficient r multiplied by a scale factor that is the square root of the spread of the y 's divided by the spread of the x 's. Thus, $\hat{\beta}_1$ and r are closely related, although they provide somewhat different information. The sample correlation coefficient r is a measure of the **linear association** between y and x , while $\hat{\beta}_1$ measures the change in the mean of y for a unit change in x . In the case of a controllable variable x , r has no meaning because the magnitude of r depends on the choice of spacing for x . We may also write, from Eq. (2.66),

$$r^2 = \hat{\beta}_1^2 \frac{S_{xx}}{SS_T} = \frac{\hat{\beta}_1 S_{xy}}{SS_T} = \frac{SS_R}{SS_T} = R^2$$

which we recognize from Eq. (2.47) as the coefficient of determination. That is, the coefficient of determination R^2 is just the square of the correlation coefficient between y and x .

While regression and correlation are closely related, regression is a more powerful tool in many situations. Correlation is only a measure of association and is of little use in prediction. However, regression methods are useful in developing quantitative relationships between variables, which can be used in prediction.

It is often useful to test the hypothesis that the correlation coefficient equals zero, that is,

$$H_0: \rho = 0, \quad H_1: \rho \neq 0 \tag{2.67}$$

The appropriate test statistic for this hypothesis is

$$t_0 = \frac{r\sqrt{n-2}}{\sqrt{1-r^2}} \tag{2.68}$$

which follows the t distribution with $n - 2$ degrees of freedom if $H_0: \rho = 0$ is true. Therefore, we would reject the null hypothesis if $|t_0| > t_{\alpha/2, n-2}$. This test is equivalent to the t test for $H_0: \beta_1 = 0$ given in Section 2.3. This equivalence follows directly from Eq. (2.66).

The test procedure for the hypotheses

$$H_0: \rho = \rho_0, \quad H_1: \rho \neq \rho_0 \tag{2.69}$$

where $\rho_0 \neq 0$ is somewhat more complicated. For moderately large samples (e.g., $n \geq 25$) the statistic

$$Z = \operatorname{arctanh} r = \frac{1}{2} \ln \frac{1+r}{1-r} \tag{2.70}$$

is approximately normally distributed with mean

$$\mu_Z = \operatorname{arctanh} \rho = \frac{1}{2} \ln \frac{1+\rho}{1-\rho}$$

and variance

$$\sigma_Z^2 = (n-3)^{-1}$$

Therefore, to test the hypothesis $H_0: \rho = \rho_0$, we may compute the statistic

$$Z_0 = (\operatorname{arctanh} r - \operatorname{arctanh} \rho_0)(n-3)^{1/2} \quad (2.71)$$

and reject $H_0: \rho = \rho_0$ if $|Z_0| > Z_{\alpha/2}$.

It is also possible to construct a $100(1 - \alpha)$ percent CI for ρ using the transformation (2.70). The $100(1 - \alpha)$ percent CI is

$$\tanh\left(\operatorname{arctanh} r - \frac{Z_{\alpha/2}}{\sqrt{n-3}}\right) \leq \rho \leq \tanh\left(\operatorname{arctanh} r + \frac{Z_{\alpha/2}}{\sqrt{n-3}}\right) \quad (2.72)$$

where $\tanh u = (e^u - e^{-u})/(e^u + e^{-u})$.

Example 2.9 The Delivery Time Data

Consider the soft drink delivery time data introduced in Chapter 1. The 25 observations on delivery time y and delivery volume x are listed in Table 2.11. The scatter diagram shown in Figure 1.1 indicates a strong linear relationship between delivery time and delivery volume. The Minitab output for the simple linear regression model is in Table 2.12.

The sample correlation coefficient between delivery time y and delivery volume x is

$$r = \frac{S_{xy}}{[S_{xx}SS_T]^{1/2}} = \frac{2473.3440}{[(1136.5600)(5784.5426)]^{1/2}} = 0.9646$$

TABLE 2.11 Data Example 2.9

Observation	Delivery Time, y	Number of Cases, x	Observation	Delivery Time, y	Number of Cases, x
1	16.68	7	14	19.75	6
2	11.50	3	15	24.00	9
3	12.03	3	16	29.00	10
4	14.88	4	17	15.35	6
5	13.75	6	18	19.00	7
6	18.11	7	19	9.50	3
7	8.00	2	20	35.10	17
8	17.83	7	21	17.90	10
9	79.24	30	22	52.32	26
10	21.50	5	23	18.75	9
11	40.33	16	24	19.83	8
12	21.00	10	25	10.75	4
13	13.50	4			

TABLE 2.12 MINITAB Output for Soft Drink Delivery Time Data

Regression Analysis: Time versus Cases

The regression equation is
 Time = 3.32 + 2.18 Cases

Predictor	Coef	SE Coef	T	P
Constant	3.321	1.371	2.42	0.024
Cases	2.1762	0.1240	17.55	0.000

S = 4.18140 R- Sq= 93.0% R- Sq(adj) = 92.7%

Analysis of Variance

Source	DF	SS	MS	F	P
Regression	1	5382.4	5382.4	307.85	0.000
Residual Error	23	402.1	17.5		
Total	24	5784.5			

If we assume that delivery time and delivery volume are jointly normally distributed, we may test the hypotheses

$$H_0: \rho = 0, \quad H_1: \rho \neq 0$$

using the test statistic

$$t_0 = \frac{r\sqrt{n-2}}{\sqrt{1-r^2}} = \frac{0.9646\sqrt{23}}{\sqrt{1-0.9305}} = 17.55$$

Since $t_{0.025,23} = 2.069$, we reject H_0 and conclude that the correlation coefficient $\rho \neq 0$. Note from the Minitab output in Table 2.12 that this is identical to the t -test statistic for $H_0: \beta_1 = 0$. Finally, we may construct an approximate 95% CI on ρ from (2.72). Since $\operatorname{arctanh} r = \operatorname{arctanh} 0.9646 = 2.0082$, Eq. (2.72) becomes

$$\tanh\left(2.0082 - \frac{1.96}{\sqrt{22}}\right) \leq \rho \leq \tanh\left(2.0082 + \frac{1.96}{\sqrt{22}}\right)$$

which reduces to

$$0.9202 \leq \rho \leq 0.9845 \quad \blacksquare$$

Although we know that delivery time and delivery volume are highly correlated, this information is of little use in predicting, for example, delivery time as a function of the number of cases of product delivered. This would require a regression model. The straight-line fit (shown graphically in Figure 1.1b) relating delivery time to delivery volume is

$$\hat{y} = 3.321 + 2.1762x$$

Further analysis would be required to determine if this equation is an adequate fit to the data and if it is likely to be a successful predictor.

PROBLEMS

- 2.1** Table B.1 gives data concerning the performance of the 26 National Football League teams in 1976. It is suspected that the number of yards gained rushing by opponents (x_8) has an effect on the number of games won by a team (y).
- Fit a simple linear regression model relating games won y to yards gained rushing by opponents x_8 .
 - Construct the analysis-of-variance table and test for significance of regression.
 - Find a 95% CI on the slope.
 - What percent of the total variability in y is explained by this model?
 - Find a 95% CI on the mean number of games won if opponents' yards rushing is limited to 2000 yards.
- 2.2** Suppose we would like to use the model developed in Problem 2.1 to predict the number of games a team will win if it can limit opponents' yards rushing to 1800 yards. Find a point estimate of the number of games won when $x_8 = 1800$. Find a 90% prediction interval on the number of games won.
- 2.3** Table B.2 presents data collected during a solar energy project at Georgia Tech.
- Fit a simple linear regression model relating total heat flux y (kilowatts) to the radial deflection of the deflected rays x_4 (milliradians).
 - Construct the analysis-of-variance table and test for significance of regression.
 - Find a 99% CI on the slope.
 - Calculate R^2 .
 - Find a 95% CI on the mean heat flux when the radial deflection is 16.5 milliradians.
- 2.4** Table B.3 presents data on the gasoline mileage performance of 32 different automobiles.
- Fit a simple linear regression model relating gasoline mileage y (miles per gallon) to engine displacement x_1 (cubic inches).
 - Construct the analysis-of-variance table and test for significance of regression.
 - What percent of the total variability in gasoline mileage is accounted for by the linear relationship with engine displacement?
 - Find a 95% CI on the mean gasoline mileage if the engine displacement is 275 in.³
 - Suppose that we wish to predict the gasoline mileage obtained from a car with a 275-in.³ engine. Give a point estimate of mileage. Find a 95% prediction interval on the mileage.
 - Compare the two intervals obtained in parts d and e. Explain the difference between them. Which one is wider, and why?

- 2.5** Consider the gasoline mileage data in Table B.3. Repeat Problem 2.4 (parts a, b, and c) using vehicle weight x_{10} as the regressor variable. Based on a comparison of the two models, can you conclude that x_1 is a better choice of regressor than x_{10} ?
- 2.6** Table B.4 presents data for 27 houses sold in Erie, Pennsylvania.
- Fit a simple linear regression model relating selling price of the house to the current taxes (x_1).
 - Test for significance of regression.
 - What percent of the total variability in selling price is explained by this model?
 - Find a 95% CI on β_1 .
 - Find a 95% CI on the mean selling price of a house for which the current taxes are \$750.
- 2.7** The purity of oxygen produced by a fractional distillation process is thought to be related to the percentage of hydrocarbons in the main condensor of the processing unit. Twenty samples are shown below.

Purity (%)	Hydrocarbon (%)	Purity (%)	Hydrocarbon (%)
86.91	1.02	96.73	1.46
89.85	1.11	99.42	1.55
90.28	1.43	98.66	1.55
86.34	1.11	96.07	1.55
92.58	1.01	93.65	1.40
87.33	0.95	87.31	1.15
86.29	1.11	95.00	1.01
91.86	0.87	96.85	0.99
95.61	1.43	85.20	0.95
89.86	1.02	90.56	0.98

- Fit a simple linear regression model to the data.
 - Test the hypothesis $H_0: \beta_1 = 0$.
 - Calculate R^2 .
 - Find a 95% CI on the slope.
 - Find a 95% CI on the mean purity when the hydrocarbon percentage is 1.00.
- 2.8** Consider the oxygen plant data in Problem 2.7 and assume that purity and hydrocarbon percentage are jointly normally distributed random variables.
- What is the correlation between oxygen purity and hydrocarbon percentage?
 - Test the hypothesis that $\rho = 0$.
 - Construct a 95% CI for ρ .
- 2.9** Consider the soft drink delivery time data in Table 2.9. After examining the original regression model (Example 2.9), one analyst claimed that the model

was invalid because the intercept was not zero. He argued that if zero cases were delivered, the time to stock and service the machine would be zero, and the straight-line model should go through the origin. What would you say in response to his comments? Fit a no-intercept model to these data and determine which model is superior.

- 2.10** The weight and systolic blood pressure of 26 randomly selected males in the age group 25–30 are shown below. Assume that weight and blood pressure (BP) are jointly normally distributed.
- Find a regression line relating systolic blood pressure to weight.
 - Estimate the correlation coefficient.
 - Test the hypothesis that $\rho = 0$.
 - Test the hypothesis that $\rho = 0.6$.
 - Find a 95% CI for ρ .

Subject	Weight	Symbolic BP	Subject	Weight	Systolic BP
1	165	130	14	172	153
2	167	133	15	159	128
3	180	150	16	168	132
4	155	128	17	174	149
5	212	151	18	183	158
6	175	146	19	215	150
7	190	150	20	195	163
8	210	140	21	180	156
9	200	148	22	143	124
10	149	125	23	240	170
11	158	133	24	235	165
12	169	135	25	192	160
13	170	150	26	187	159

- 2.11** Consider the weight and blood pressure data in Problem 2.10. Fit a no-intercept model to the data and compare it to the model obtained in Problem 2.10. Which model would you conclude is superior?
- 2.12** The number of pounds of steam used per month at a plant is thought to be related to the average monthly ambient temperature. The past year's usages and temperatures follow.

Month	Temperature	Usage/1000	Month	Temperature	Usage/1000
Jan.	21	185.79	Jul.	68	621.55
Feb.	24	214.47	Aug.	74	675.06
Mar.	32	288.03	Sep.	62	562.03
Apr.	47	424.84	Oct.	50	452.93
May	50	454.68	Nov.	41	369.95
Jun.	59	539.03	Dec.	30	273.98

- a. Fit a simple linear regression model to the data.
- b. Test for significance of regression.
- c. Plant management believes that an increase in average ambient temperature of 1 degree will increase average monthly steam consumption by 10,000 lb. Do the data support this statement?
- d. Construct a 99% prediction interval on steam usage in a month with average ambient temperature of 58°.

2.13 Davidson (“Update on Ozone Trends in California’s South Coast Air Basin,” *Air and Waste*, **43**, 226, 1993) studied the ozone levels in the South Coast Air Basin of California for the years 1976–1991. He believes that the number of days the ozone levels exceeded 0.20 ppm (the response) depends on the seasonal meteorological index, which is the seasonal average 850-millibar temperature (the regressor). The following table gives the data.

Year	Days	Index
1976	91	16.7
1977	105	17.1
1978	106	18.2
1979	108	18.1
1980	88	17.2
1981	91	18.2
1982	58	16.0
1983	82	17.2
1984	81	18.0
1985	65	17.2
1986	61	16.9
1987	48	17.1
1988	61	18.2
1989	43	17.3
1990	33	17.5
1991	36	16.6

- a. Make a scatterplot of the data.
 - b. Estimate the prediction equation.
 - c. Test for significance of regression.
 - d. Calculate and plot the 95% confidence and prediction bands.
- 2.14** Hsue, Ma, and Tsai (“Separation and Characterizations of Thermotropic Copolyesters of *p*-Hydroxybenzoic Acid, Sebacic Acid, and Hydroquinone,” *Journal of Applied Polymer Science*, **56**, 471–476, 1995) study the effect of the molar ratio of sebacic acid (the regressor) on the intrinsic viscosity of copolyesters (the response). The following table gives the data.

Ratio	Viscosity
1.0	0.45
0.9	0.20
0.8	0.34
0.7	0.58
0.6	0.70
0.5	0.57
0.4	0.55
0.3	0.44

- a. Make a scatterplot of the data.
 - b. Estimate the prediction equation.
 - c. Perform a complete, appropriate analysis (statistical tests, calculation of R^2 , and so forth).
 - d. Calculate and plot the 95% confidence and prediction bands.
- 2.15** Byers and Williams (“Viscosities of Binary and Ternary Mixtures of Polynomatic Hydrocarbons,” *Journal of Chemical and Engineering Data*, **32**, 349–354, 1987) studied the impact of temperature on the viscosity of toluene–tetralin blends. The following table gives the data for blends with a 0.4 molar fraction of toluene.

Temperature (°C)	Viscosity (mPa · s)
24.9	1.1330
35.0	0.9772
44.9	0.8532
55.1	0.7550
65.2	0.6723
75.2	0.6021
85.2	0.5420
95.2	0.5074

- a. Estimate the prediction equation.
 - b. Perform a complete analysis of the model.
 - c. Calculate and plot the 95% confidence and prediction bands.
- 2.16** Carroll and Spiegelman (“The Effects of Ignoring Small Measurement Errors in Precision Instrument Calibration,” *Journal of Quality Technology*, **18**, 170–173, 1986) look at the relationship between the pressure in a tank and the volume of liquid. The following table gives the data. Use an appropriate statistical software package to perform an analysis of these data. Comment on the output produced by the software routine.

Volume	Pressure	Volume	Pressure	Volume	Pressure
2084	4599	2842	6380	3789	8599
2084	4600	3030	6818	3789	8600
2273	5044	3031	6817	3979	9048
2273	5043	3031	6818	3979	9048
2273	5044	3221	7266	4167	9484
2463	5488	3221	7268	4168	9487
2463	5487	3409	7709	4168	9487
2651	5931	3410	7710	4358	9936
2652	5932	3600	8156	4358	9938
2652	5932	3600	8158	4546	10377
2842	6380	3788	8597	4547	10379

2.17 Atkinson (*Plots, Transformations, and Regression*, Clarendon Press, Oxford, 1985) presents the following data on the boiling point of water (°F) and barometric pressure (inches of mercury). Construct a scatterplot of the data and propose a model that relates a model that relates boiling point to barometric pressure. Fit the model to the data and perform a complete analysis of the model using the techniques we have discussed in this chapter.

Boiling Point	Barometric Pressure	Boiling Point	Barometric Pressure
199.5	20.79	201.9	24.02
199.3	20.79	201.3	24.01
197.9	22.40	203.6	25.14
198.4	22.67	204.6	26.57
199.4	23.15	209.5	28.49
199.9	23.35	208.6	27.76
200.9	23.89	210.7	29.64
201.1	23.99	211.9	29.88
		212.2	30.06

2.18 On March 1, 1984, the *Wall Street Journal* published a survey of television advertisements conducted by Video Board Tests, Inc., a New York ad-testing company that interviewed 4000 adults. These people were regular product users who were asked to cite a commercial they had seen for that product category in the past week. In this case, the response is the number of millions of retained impressions per week. The regressor is the amount of money spent by the firm on advertising. The data follow.

Firm	Amount Spent (millions)	Returned Impressions per week (millions)
Miller Lite	50.1	32.1
Pepsi	74.1	99.6
Stroh's	19.3	11.7

(Continued)

Firm	Amount Spent (millions)	Returned Impressions per week (millions)
Federal Express	22.9	21.9
Burger King	82.4	60.8
Coca-Cola	40.1	78.6
McDonald's	185.9	92.4
MCI	26.9	50.7
Diet Cola	20.4	21.4
Ford	166.2	40.1
Levi's	27	40.8
Bud Lite	45.6	10.4
ATT Bell	154.9	88.9
Calvin Klein	5	12
Wendy's	49.7	29.2
Polaroid	26.9	38
Shasta	5.7	10
Meow Mix	7.6	12.3
Oscar Meyer	9.2	23.4
Crest	32.4	71.1
Kibbles N Bits	6.1	4.4

- a. Fit the simple linear regression model to these data.
 - b. Is there a significant relationship between the amount a company spends on advertising and retained impressions? Justify your answer statistically.
 - c. Construct the 95% confidence and prediction bands for these data.
 - d. Give the 95% confidence and prediction intervals for the number of retained impressions for MCI.
- 2.19** Table B.17 Contains the Patient Satisfaction data used in Section 2.7.
- a. Fit a simple linear regression model relating satisfaction to age.
 - b. Compare this model to the fit in Section 2.7 relating patient satisfaction to severity.
- 2.20** Consider the fuel consumption data given in Table B.18. The automotive engineer believes that the initial boiling point of the fuel controls the fuel consumption. Perform a thorough analysis of these data. Do the data support the engineer's belief?
- 2.21** Consider the wine quality of young red wines data in Table B.19. The wine-makers believe that the sulfur content has a negative impact on the taste (thus, the overall quality) of the wine. Perform a thorough analysis of these data. Do the data support the winemakers' belief?
- 2.22** Consider the methanol oxidation data in Table B.20. The chemist believes that ratio of inlet oxygen to the inlet methanol controls the conversion process. Perform a through analysis of these data. Do the data support the chemist's belief?
- 2.23** Consider the simple linear regression model $y = 50 + 10x + \varepsilon$ where ε is NID $(0, 16)$. Suppose that $n = 20$ pairs of observations are used to fit this model.

Generate 500 samples of 20 observations, drawing one observation for each level of $x = 1, 1.5, 2, \dots, 10$ for each sample.

- a. For each sample compute the least-squares estimates of the slope and intercept. Construct histograms of the sample values of $\hat{\beta}_0$ and $\hat{\beta}_1$. Discuss the shape of these histograms.
- b. For each sample, compute an estimate of $E(y|x = 5)$. Construct a histogram of the estimates you obtained. Discuss the shape of the histogram.
- c. For each sample, compute a 95% CI on the slope. How many of these intervals contain the true value $\beta_1 = 10$? Is this what you would expect?
- d. For each estimate of $E(y|x = 5)$ in part b, compute the 95% CI. How many of these intervals contain the true value of $E(y|x = 5) = 100$? Is this what you would expect?

2.24 Repeat Problem 2.20 using only 10 observations in each sample, drawing one observation from each level $x = 1, 2, 3, \dots, 10$. What impact does using $n = 10$ have on the questions asked in Problem 2.17? Compare the lengths of the CIs and the appearance of the histograms.

2.25 Consider the simple linear regression model $y = \beta_0 + \beta_1 x + \varepsilon$, with $E(\varepsilon) = 0$, $\text{Var}(\varepsilon) = \sigma^2$, and ε uncorrelated.

a. Show that $\text{Cov}(\hat{\beta}_0, \hat{\beta}_1) = -\bar{x}\sigma^2/S_{xx}$.

b. Show that $\text{Cov}(\bar{y}, \hat{\beta}_1) = 0$.

2.26 Consider the simple linear regression model $y = \beta_0 + \beta_1 x + \varepsilon$, with $E(\varepsilon) = 0$, $\text{Var}(\varepsilon) = \sigma^2$, and ε uncorrelated.

a. Show that $E(MS_R) = \sigma^2 + \beta_1^2 S_{xx}$.

b. Show that $E(MS_{Res}) = \sigma^2$.

2.27 Suppose that we have fit the straight-line regression model $\hat{y} = \hat{\beta}_0 + \hat{\beta}_1 x_1$ but the response is affected by a second variable x_2 such that the true regression function is

$$E(y) = \beta_0 + \beta_1 x_1 + \beta_2 x_2$$

a. Is the least-squares estimator of the slope in the original simple linear regression model unbiased?

b. Show the bias in $\hat{\beta}_1$.

2.28 Consider the maximum-likelihood estimator $\tilde{\sigma}^2$ of σ^2 in the simple linear regression model. We know that $\tilde{\sigma}^2$ is a biased estimator for σ^2 .

a. Show the amount of bias in $\tilde{\sigma}^2$.

b. What happens to the bias as the sample size n becomes large?

2.29 Suppose that we are fitting a straight line and wish to make the standard error of the slope as small as possible. Suppose that the “region of interest” for x is $-1 \leq x \leq 1$. Where should the observations x_1, x_2, \dots, x_n be taken? Discuss the practical aspects of this data collection plan.

- 2.30** Consider the data in Problem 2.12 and assume that steam usage and average temperature are jointly normally distributed.
- Find the correlation between steam usage and monthly average ambient temperature.
 - Test the hypothesis that $\rho = 0$.
 - Test the hypothesis that $\rho = 0.5$.
 - Find a 99% CI for ρ .
- 2.31** Prove that the maximum value of R^2 is less than 1 if the data contain repeated (different) observations on y at the same value of x .
- 2.32** Consider the simple linear regression model

$$y = \beta_0 + \beta_1 x + \varepsilon$$

where the intercept β_0 is known.

- Find the least-squares estimator of β_1 for this model. Does this answer seem reasonable?
 - What is the variance of the slope ($\hat{\beta}_1$) for the least-squares estimator found in part a?
 - Find a $100(1 - \alpha)$ percent CI for β_1 . Is this interval narrower than the estimator for the case where both slope and intercept are unknown?
- 2.33** Consider the least-squares residuals $e_i = y_i - \hat{y}_i, i = 1, 2, \dots, n$, from the simple linear regression model. Find the variance of the residuals $\text{Var}(e_i)$. Is the variance of the residuals a constant? Discuss.

CHAPTER 3

MULTIPLE LINEAR REGRESSION

A regression model that involves more than one regressor variable is called a **multiple regression model**. Fitting and analyzing these models is discussed in this chapter. The results are extensions of those in Chapter 2 for simple linear regression.

3.1 MULTIPLE REGRESSION MODELS

Suppose that the yield in pounds of conversion in a chemical process depends on temperature and the catalyst concentration. A multiple regression model that might describe this relationship is

$$y = \beta_0 + \beta_1 x_1 + \beta_2 x_2 + \varepsilon \quad (3.1)$$

where y denotes the yield, x_1 denotes the temperature, and x_2 denotes the catalyst concentration. This is a **multiple linear regression model** with two regressor variables. The term **linear** is used because Eq. (3.1) is a linear function of the unknown parameters β_0 , β_1 and β_2 .

The regression model in Eq. (3.1) describes a plane in the three-dimensional space of y , x_1 and x_2 . Figure 3.1a shows this regression plane for the model

$$E(y) = 50 + 10x_1 + 7x_2$$

where we have assumed that the expected value of the error term ε in Eq. (3.1) is zero. The parameter β_0 is the intercept of the regression plane. If the range of the data includes $x_1 = x_2 = 0$, then β_0 is the mean of y when $x_1 = x_2 = 0$. Otherwise β_0 has

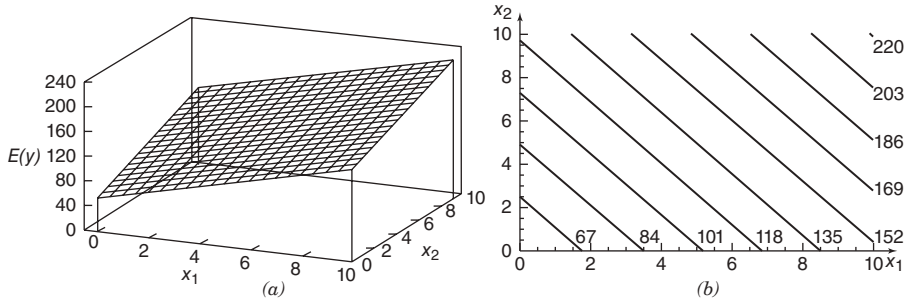

Figure 3.1 (a) The regression plane for the model $E(y) = 50 + 10x_1 + 7x_2$. (b) The contour plot.

no physical interpretation. The parameter β_1 indicates the expected change in response (y) per unit change in x_1 when x_2 is held constant. Similarly β_2 measures the expected change in y per unit change in x_2 when x_1 is held constant. Figure 3.1b shows a **contour plot** of the regression model, that is, lines of constant expected response $E(y)$ as a function of x_1 and x_2 . Notice that the contour lines in this plot are parallel straight lines.

In general, the **response** y may be related to k **regressor** or **predictor variables**. The model

$$y = \beta_0 + \beta_1 x_1 + \beta_2 x_2 + \dots + \beta_k x_k + \varepsilon \quad (3.2)$$

is called a **multiple linear regression model** with k regressors. The parameters β_j , $j = 0, 1, \dots, k$, are called the **regression coefficients**. This model describes a hyperplane in the k -dimensional space of the regressor variables x_j . The parameter β_j represents the expected change in the response y per unit change in x_j **when all of the remaining regressor variables $x_i (i \neq j)$ are held constant**. For this reason the parameters β_j , $j = 1, 2, \dots, k$, are often called **partial regression coefficients**.

Multiple linear regression models are often used as **empirical models** or approximating functions. That is, the true functional relationship between y and x_1, x_2, \dots, x_k is unknown, but over certain ranges of the regressor variables the linear regression model is an adequate approximation to the true unknown function.

Models that are more complex in structure than Eq. (3.2) may often still be analyzed by multiple linear regression techniques. For example, consider the cubic polynomial model

$$y = \beta_0 + \beta_1 x + \beta_2 x^2 + \beta_3 x^3 + \varepsilon \quad (3.3)$$

If we let $x_1 = x$, $x_2 = x^2$, and $x_3 = x^3$, then Eq. (3.3) can be written as

$$y = \beta_0 + \beta_1 x_1 + \beta_2 x_2 + \beta_3 x_3 + \varepsilon \quad (3.4)$$

which is a multiple linear regression model with three regressor variables. Polynomial models are discussed in more detail in Chapter 7.

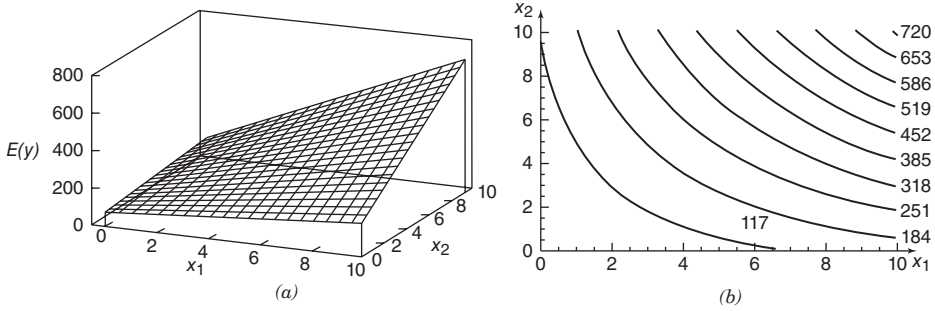

Figure 3.2 (a) Three-dimensional plot of regression model $E(y) = 50 + 10x_1 + 7x_2 + 5x_1x_2$. (b) The contour plot.

Models that include **interaction effects** may also be analyzed by multiple linear regression methods. For example, suppose that the model is

$$y = \beta_0 + \beta_1x_1 + \beta_2x_2 + \beta_{12}x_1x_2 + \varepsilon \tag{3.5}$$

If we let $x_3 = x_1x_2$ and $\beta_3 = \beta_{12}$, then Eq. (3.5) can be written as

$$y = \beta_0 + \beta_1x_1 + \beta_2x_2 + \beta_3x_3 + \varepsilon \tag{3.6}$$

which is a linear regression model.

Figure 3.2a shows the three-dimensional plot of the regression model

$$y = 50 + 10x_1 + 7x_2 + 5x_1x_2$$

and Figure 3.2b the corresponding two-dimensional contour plot. Notice that, although this model is a linear regression model, the shape of the surface that is generated by the model is not linear. In general, **any regression model that is linear in the parameters** (the β 's) **is a linear regression model, regardless of the shape of the surface that it generates.**

Figure 3.2 provides a nice graphical interpretation of an interaction. Generally, interaction implies that the effect produced by changing one variable (x_1 , say) depends on the level of the other variable (x_2). For example, Figure 3.2 shows that changing x_1 from 2 to 8 produces a much smaller change in $E(y)$ when $x_2 = 2$ than when $x_2 = 10$. Interaction effects occur frequently in the study and analysis of real-world systems, and regression methods are one of the techniques that we can use to describe them.

As a final example, consider the **second-order model with interaction**

$$y = \beta_0 + \beta_1x_1 + \beta_2x_2 + \beta_{11}x_1^2 + \beta_{22}x_2^2 + \beta_{12}x_1x_2 + \varepsilon \tag{3.7}$$

If we let $x_3 = x_1^2$, $x_4 = x_2^2$, $x_5 = x_1x_2$, $\beta_3 = \beta_{11}$, $\beta_4 = \beta_{22}$, and $\beta_5 = \beta_{12}$, then Eq. (3.7) can be written as a multiple linear regression model as follows:

$$y = \beta_0 + \beta_1x_1 + \beta_2x_2 + \beta_3x_3 + \beta_4x_4 + \beta_5x_5 + \varepsilon$$

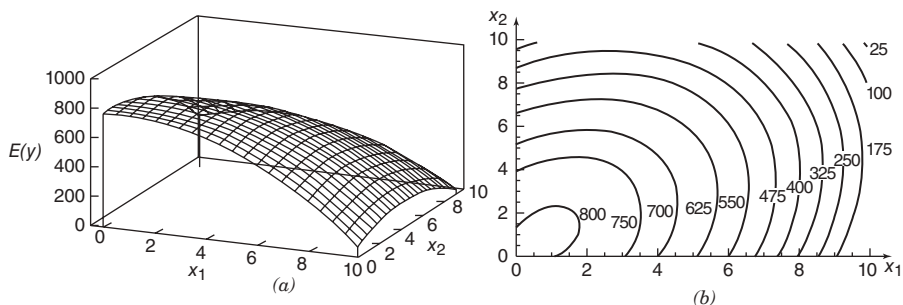

Figure 3.3 (a) Three-dimensional plot of the regression model $E(y) = 800 + 10x_1 + 7x_2 - 8.5x_1^2 - 5x_2^2 + 4x_1x_2$, (b) The contour plot.

Figure 3.3 shows the three-dimensional plot and the corresponding contour plot for

$$E(y) = 800 + 10x_1 + 7x_2 - 8.5x_1^2 - 5x_2^2 + 4x_1x_2$$

These plots indicate that the expected change in y when x_1 is changed by one unit (say) is a function of **both** x_1 and x_2 . The quadratic and interaction terms in this model produce a mound-shaped function. Depending on the values of the regression coefficients, the second-order model with interaction is capable of assuming a wide variety of shapes; thus, it is a very flexible regression model.

In most real-world problems, the values of the parameters (the regression coefficients β_i) and the error variance σ^2 are not known, and they must be estimated from sample data. The fitted regression equation or model is typically used in prediction of future observations of the response variable y or for estimating the mean response at particular levels of the y 's.

3.2 ESTIMATION OF THE MODEL PARAMETERS

3.2.1 Least-Squares Estimation of the Regression Coefficients

The **method of least squares** can be used to estimate the regression coefficients in Eq. (3.2). Suppose that $n > k$ observations are available, and let y_i denote the i th observed response and x_{ij} denote the i th observation or level of regressor x_j . The data will appear as in Table 3.1. We assume that the error term ε in the model has $E(\varepsilon) = 0$, $\text{Var}(\varepsilon) = \sigma^2$, and that the errors are uncorrelated.

TABLE 3.1 Data for Multiple Linear Regression

Observation, i	Response, y	Regressors			
		x_1	x_2	\dots	x_k
1	y_1	x_{11}	x_{12}	\dots	x_{1k}
2	y_2	x_{21}	x_{22}	\dots	x_{2k}
\vdots	\vdots	\vdots	\vdots	\vdots	\vdots
n	y_n	x_{n1}	x_{n2}	\dots	x_{nk}

Note that there are $p = k + 1$ normal equations, one for each of the unknown regression coefficients. The solution to the normal equations will be the **least-squares estimators** $\hat{\beta}_0, \hat{\beta}_1, \dots, \hat{\beta}_k$.

It is more convenient to deal with multiple regression models if they are expressed in matrix notation. This allows a very compact display of the model, data, and results. In matrix notation, the model given by Eq. (3.8) is

$$\mathbf{y} = \mathbf{X}\boldsymbol{\beta} + \boldsymbol{\varepsilon}$$

where

$$\mathbf{y} = \begin{bmatrix} y_1 \\ y_2 \\ \vdots \\ y_n \end{bmatrix}, \quad \mathbf{X} = \begin{bmatrix} 1 & x_{11} & x_{12} & \cdots & x_{1k} \\ 1 & x_{21} & x_{22} & \cdots & x_{2k} \\ \vdots & \vdots & \vdots & & \vdots \\ 1 & x_{n1} & x_{n2} & \cdots & x_{nk} \end{bmatrix}$$

$$\boldsymbol{\beta} = \begin{bmatrix} \beta_0 \\ \beta_1 \\ \vdots \\ \beta_k \end{bmatrix}, \quad \boldsymbol{\varepsilon} = \begin{bmatrix} \varepsilon_1 \\ \varepsilon_2 \\ \vdots \\ \varepsilon_n \end{bmatrix}$$

In general, \mathbf{y} is an $n \times 1$ vector of the observations, \mathbf{X} is an $n \times p$ matrix of the levels of the regressor variables, $\boldsymbol{\beta}$ is a $p \times 1$ vector of the regression coefficients, and $\boldsymbol{\varepsilon}$ is an $n \times 1$ vector of random errors.

We wish to find the vector of least-squares estimators, $\hat{\boldsymbol{\beta}}$, that minimizes

$$S(\boldsymbol{\beta}) = \sum_{i=1}^n \varepsilon_i^2 = \boldsymbol{\varepsilon}'\boldsymbol{\varepsilon} = (\mathbf{y} - \mathbf{X}\boldsymbol{\beta})'(\mathbf{y} - \mathbf{X}\boldsymbol{\beta})$$

Note that $S(\boldsymbol{\beta})$ may be expressed as

$$\begin{aligned} S(\boldsymbol{\beta}) &= \mathbf{y}'\mathbf{y} - \boldsymbol{\beta}'\mathbf{X}'\mathbf{y} - \mathbf{y}'\mathbf{X}\boldsymbol{\beta} + \boldsymbol{\beta}'\mathbf{X}'\mathbf{X}\boldsymbol{\beta} \\ &= \mathbf{y}'\mathbf{y} - 2\boldsymbol{\beta}'\mathbf{X}'\mathbf{y} + \boldsymbol{\beta}'\mathbf{X}'\mathbf{X}\boldsymbol{\beta} \end{aligned}$$

since $\boldsymbol{\beta}'\mathbf{X}'\mathbf{y}$ is a 1×1 matrix, or a scalar, and its transpose $(\boldsymbol{\beta}'\mathbf{X}'\mathbf{y})' = \mathbf{y}'\mathbf{X}\boldsymbol{\beta}$ is the same scalar. The least-squares estimators must satisfy

$$\left. \frac{\partial S}{\partial \boldsymbol{\beta}} \right|_{\hat{\boldsymbol{\beta}}} = -2\mathbf{X}'\mathbf{y} + 2\mathbf{X}'\mathbf{X}\hat{\boldsymbol{\beta}} = \mathbf{0}$$

which simplifies to

$$\mathbf{X}'\mathbf{X}\hat{\boldsymbol{\beta}} = \mathbf{X}'\mathbf{y} \quad (3.12)$$

Equations (3.12) are the **least-squares normal equations**. They are the matrix analogue of the scalar presentation in (3.11).

To solve the normal equations, multiply both sides of (3.12) by the inverse of $\mathbf{X}'\mathbf{X}$. Thus, the **least-squares estimator** of $\boldsymbol{\beta}$ is

$$\hat{\boldsymbol{\beta}} = (\mathbf{X}'\mathbf{X})^{-1} \mathbf{X}'\mathbf{y} \quad (3.13)$$

provided that the inverse matrix $(\mathbf{X}'\mathbf{X})^{-1}$ exists. The $(\mathbf{X}'\mathbf{X})^{-1}$ matrix will always exist if the regressors are **linearly independent**, that is, if no column of the \mathbf{X} matrix is a linear combination of the other columns.

It is easy to see that the matrix form of the normal equations (3.12) is identical to the scalar form (3.11). Writing out (3.12) in detail, we obtain

$$\begin{bmatrix} n & \sum_{i=1}^n x_{i1} & \sum_{i=1}^n x_{i2} & \cdots & \sum_{i=1}^n x_{ik} \\ \sum_{i=1}^n x_{i1} & \sum_{i=1}^n x_{i1}^2 & \sum_{i=1}^n x_{i1}x_{i2} & \cdots & \sum_{i=1}^n x_{i1}x_{ik} \\ \vdots & \vdots & \vdots & \vdots & \vdots \\ \sum_{i=1}^n x_{ik} & \sum_{i=1}^n x_{ik}x_{i1} & \sum_{i=1}^n x_{ik}x_{i2} & \cdots & \sum_{i=1}^n x_{ik}^2 \end{bmatrix} \begin{bmatrix} \hat{\beta}_0 \\ \hat{\beta}_1 \\ \vdots \\ \hat{\beta}_k \end{bmatrix} = \begin{bmatrix} \sum_{i=1}^n y_i \\ \sum_{i=1}^n x_{i1}y_i \\ \vdots \\ \sum_{i=1}^n x_{ik}y_i \end{bmatrix}$$

If the indicated matrix multiplication is performed, the scalar form of the normal equations (3.11) is obtained. In this display we see that $\mathbf{X}'\mathbf{X}$ is a $p \times p$ symmetric matrix and $\mathbf{X}'\mathbf{y}$ is a $p \times 1$ column vector. Note the special structure of the $\mathbf{X}'\mathbf{X}$ matrix. The diagonal elements of $\mathbf{X}'\mathbf{X}$ are the sums of squares of the elements in the columns of \mathbf{X} , and the off-diagonal elements are the sums of cross products of the elements in the columns of \mathbf{X} . Furthermore, note that the elements of $\mathbf{X}'\mathbf{y}$ are the sums of cross products of the columns of \mathbf{X} and the observations y_i .

The fitted regression model corresponding to the levels of the regressor variables $\mathbf{x}' = [1, x_1, x_2, \dots, x_k]$ is

$$\hat{y} = \mathbf{x}'\hat{\boldsymbol{\beta}} = \hat{\beta}_0 + \sum_{j=1}^k \hat{\beta}_j x_j$$

The vector of fitted values \hat{y}_i corresponding to the observed values y_i is

$$\hat{\mathbf{y}} = \mathbf{X}\hat{\boldsymbol{\beta}} = \mathbf{X}(\mathbf{X}'\mathbf{X})^{-1} \mathbf{X}'\mathbf{y} = \mathbf{H}\mathbf{y} \quad (3.14)$$

The $n \times n$ matrix $\mathbf{H} = \mathbf{X}(\mathbf{X}'\mathbf{X})^{-1} \mathbf{X}'$ is usually called the **hat matrix**. It maps the vector of observed values into a vector of fitted values. The hat matrix and its properties play a central role in regression analysis.

The difference between the observed value y_i and the corresponding fitted value \hat{y}_i is the **residual** $e_i = y_i - \hat{y}_i$. The n residuals may be conveniently written in matrix notation as

$$\mathbf{e} = \mathbf{y} - \hat{\mathbf{y}} \quad (3.15a)$$

There are several other ways to express the vector of residuals \mathbf{e} that will prove useful, including

$$\mathbf{e} = \mathbf{y} - \mathbf{X}\hat{\boldsymbol{\beta}} = \mathbf{y} - \mathbf{H}\mathbf{y} = (\mathbf{I} - \mathbf{H})\mathbf{y} \quad (3.15b)$$

Example 3.1 The Delivery Time Data

A soft drink bottler is analyzing the vending machine service routes in his distribution system. He is interested in predicting the amount of time required by the route driver to service the vending machines in an outlet. This service activity includes stocking the machine with beverage products and minor maintenance or house-keeping. The industrial engineer responsible for the study has suggested that the two most important variables affecting the delivery time (y) are the number of cases of product stocked (x_1) and the distance walked by the route driver (x_2). The engineer has collected 25 observations on delivery time, which are shown in Table 3.2. (Note that this is an expansion of the data set used in Example 2.9.) We will fit the multiple linear regression model

$$y = \beta_0 + \beta_1 x_1 + \beta_2 x_2 + \varepsilon$$

to the delivery time data in Table 3.2.

TABLE 3.2 Delivery Time Data for Example 3.1

Observation Number	Delivery Time, y (min)	Number of Cases, x_1	Distance, x_2 (ft)
1	16.68	7	560
2	11.50	3	220
3	12.03	3	340
4	14.88	4	80
5	13.75	6	150
6	18.11	7	330
7	8.00	2	110
8	17.83	7	210
9	79.24	30	1460
10	21.50	5	605
11	40.33	16	688
12	21.00	10	215
13	13.50	4	255
14	19.75	6	462
15	24.00	9	448
16	29.00	10	776
17	15.35	6	200
18	19.00	7	132
19	9.50	3	36
20	35.10	17	770
21	17.90	10	140
22	52.32	26	810
23	18.75	9	450
24	19.83	8	635
25	10.75	4	150

Graphics can be very useful in fitting multiple regression models. Figure 3.4 is a **scatterplot matrix** of the delivery time data. This is just a two-dimensional array of two-dimensional plots, where (except for the diagonal) each frame contains a scatter diagram. Thus, each plot is an attempt to shed light on the relationship between a pair of variables. This is often a better summary of the relationships than a numerical summary (such as displaying the correlation coefficients between each pair of variables) because it gives a sense of linearity or nonlinearity of the relationship and some awareness of how the individual data points are arranged over the region.

When there are only two regressors, sometimes a three-dimensional scatter diagram is useful in visualizing the relationship between the response and the regressors. Figure 3.5 presents this plot for the delivery time data. By spinning these plots, some software packages permit different views of the point cloud. This view provides an indication that a multiple linear regression model may provide a reasonable fit to the data.

To fit the multiple regression model we first form the \mathbf{X} matrix and \mathbf{y} vector:

$$\mathbf{X} = \begin{bmatrix} 1 & 7 & 560 \\ 1 & 3 & 220 \\ 1 & 3 & 340 \\ 1 & 4 & 80 \\ 1 & 6 & 150 \\ 1 & 7 & 330 \\ 1 & 2 & 110 \\ 1 & 7 & 210 \\ 1 & 30 & 1460 \\ 1 & 5 & 605 \\ 1 & 16 & 688 \\ 1 & 10 & 215 \\ 1 & 4 & 255 \\ 1 & 6 & 462 \\ 1 & 9 & 448 \\ 1 & 10 & 776 \\ 1 & 6 & 200 \\ 1 & 7 & 132 \\ 1 & 3 & 36 \\ 1 & 17 & 770 \\ 1 & 10 & 140 \\ 1 & 26 & 810 \\ 1 & 9 & 450 \\ 1 & 8 & 635 \\ 1 & 4 & 150 \end{bmatrix}, \quad \mathbf{y} = \begin{bmatrix} 16.68 \\ 11.50 \\ 12.03 \\ 14.88 \\ 13.75 \\ 18.11 \\ 8.00 \\ 17.83 \\ 79.24 \\ 21.50 \\ 40.33 \\ 21.00 \\ 13.50 \\ 19.75 \\ 24.00 \\ 29.00 \\ 15.35 \\ 19.00 \\ 9.50 \\ 35.10 \\ 17.90 \\ 52.32 \\ 18.75 \\ 19.83 \\ 10.75 \end{bmatrix}$$

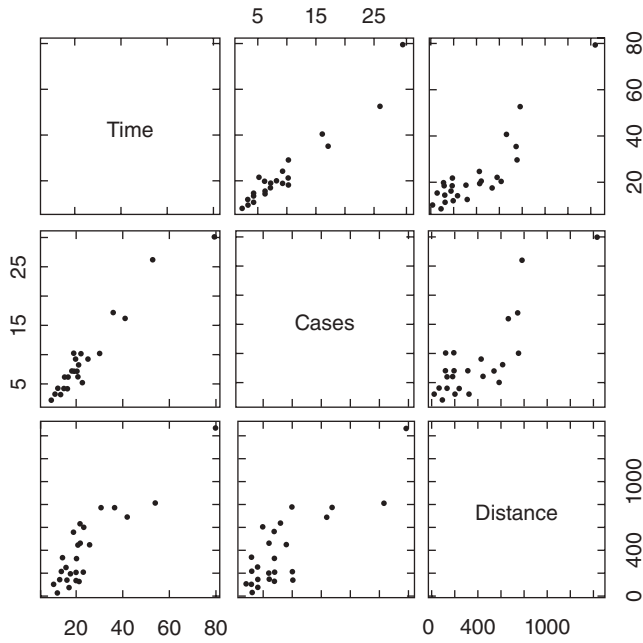

Figure 3.4 Scatterplot matrix for the delivery time data from Example 3.1.

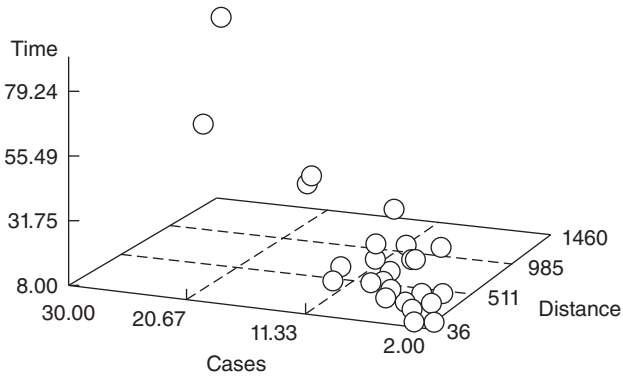

Figure 3.5 Three-dimensional scatterplot of the delivery time data from Example 3.1.

The $\mathbf{X}'\mathbf{X}$ matrix is

$$\mathbf{X}'\mathbf{X} = \begin{bmatrix} 1 & 1 & \dots & 1 \\ 7 & 3 & \dots & 4 \\ 560 & 220 & \dots & 150 \end{bmatrix} \begin{bmatrix} 1 & 7 & 560 \\ 1 & 3 & 220 \\ \vdots & \vdots & \vdots \\ 1 & 4 & 150 \end{bmatrix} = \begin{bmatrix} 25 & 219 & 10,232 \\ 219 & 3,055 & 133,899 \\ 10,232 & 133,899 & 6,725,688 \end{bmatrix}$$

and the $\mathbf{X}'\mathbf{y}$ vector is

$$\mathbf{X}'\mathbf{y} = \begin{bmatrix} 1 & 1 & \cdots & 1 \\ 7 & 3 & \cdots & 4 \\ 560 & 220 & \cdots & 150 \end{bmatrix} \begin{bmatrix} 16.68 \\ 11.50 \\ \vdots \\ 10.75 \end{bmatrix} = \begin{bmatrix} 559.60 \\ 7,375.44 \\ 337,072.00 \end{bmatrix}$$

The least-squares estimator of β is

$$\hat{\beta} = (\mathbf{X}'\mathbf{X})^{-1} \mathbf{X}'\mathbf{y}$$

or

$$\begin{aligned} \begin{bmatrix} \hat{\beta}_0 \\ \hat{\beta}_1 \\ \hat{\beta}_2 \end{bmatrix} &= \begin{bmatrix} 25 & 219 & 10,232 \\ 219 & 3,055 & 133,899 \\ 10,232 & 133,899 & 6,725,688 \end{bmatrix}^{-1} \begin{bmatrix} 559.60 \\ 7,375.44 \\ 337,072.00 \end{bmatrix} \\ &= \begin{bmatrix} 0.11321518 & -0.00444859 & -0.00008367 \\ -0.00444859 & 0.00274378 & -0.00004786 \\ -0.00008367 & -0.00004786 & 0.00000123 \end{bmatrix} \begin{bmatrix} 559.60 \\ 7,375.44 \\ 337,072.00 \end{bmatrix} \\ &= \begin{bmatrix} 2.34123115 \\ 1.61590712 \\ 0.01438483 \end{bmatrix} \end{aligned}$$

The least-squares fit (with the regression coefficients reported to five decimals) is

$$\hat{y} = 2.34123 + 1.61591x_1 + 0.01438x_2$$

Table 3.3 shows the observations y_i along with the corresponding fitted values \hat{y}_i and the residuals e_i from this model. ■

Computer Output Table 3.4 presents a portion of the Minitab output for the soft drink delivery time data in Example 3.1. While the output format differs from one computer program to another, this display contains the information typically generated. Most of the output in Table 3.4 is a straightforward extension to the multiple regression case of the computer output for simple linear regression. In the next few sections we will provide explanations of this output information.

3.2.2 A Geometrical Interpretation of Least Squares

An intuitive geometrical interpretation of least squares is sometimes helpful. We may think of the vector of observations $\mathbf{y}' = [y_1, y_2, \dots, y_n]$ as defining a vector from the origin to the point A in Figure 3.6. Note that y_1, y_2, \dots, y_n form the coordinates of an n -dimensional sample space. The sample space in Figure 3.6 is three-dimensional.

The \mathbf{X} matrix consists of p ($n \times 1$) column vectors, for example, $\mathbf{1}$ (a column vector of 1's), $\mathbf{x}_1, \mathbf{x}_2, \dots, \mathbf{x}_k$. Each of these columns defines a vector from the origin in the

TABLE 3.3 Observations, Fitted Values, and Residuals for Example 3.1

Observation Number	y_i	\hat{y}_i	$e_i = y_i - \bar{y}_i$
1	16.68	21.7081	-5.0281
2	11.50	10.3536	1.1464
3	12.03	12.0798	-0.0498
4	14.88	9.9556	4.9244
5	13.75	14.1944	-0.4444
6	18.11	18.3996	-0.2896
7	8.00	7.1554	0.8446
8	17.83	16.6734	1.1566
9	79.24	71.8203	7.4197
10	21.50	19.1236	2.3764
11	40.33	38.0925	2.2375
12	21.00	21.5930	-0.5930
13	13.50	12.4730	1.0270
14	19.75	18.6825	1.0675
15	24.00	23.3288	0.6712
16	29.00	29.6629	-0.6629
17	15.35	14.9136	0.4364
18	19.00	15.5514	3.4486
19	9.50	7.7068	1.7932
20	35.10	40.8880	-5.7880
21	17.90	20.5142	-2.6142
22	52.32	56.0065	-3.6865
23	18.75	23.3576	-4.6076
24	19.83	24.4028	-4.5728
25	10.75	10.9626	-0.2126

TABLE 3.4 Minitab Output for Soft Drink Time Data**Regression Analysis: Time versus Cases, Distance**

The regression equation is

$$\text{Time} = 2.34 + 1.62 \text{ cases} + 0.0144 \text{ Distance}$$

Predictor	Coef	SE Coef	T	P
Constant	2.341	1.097	2.13	0.044
Cases	1.6159	0.1707	9.46	0.000
Distance	0.014385	0.003613	3.98	0.001

S = 3.25947 R - Sq = 96.0% R - Sq (adj) = 95.6%

Analysis of Variance

Source	DF	SS	MS	F	P
Regression	2	5550.8	2775.4	261.24	0.000
Residual Error	22	233.7	10.6		
Total	24	5784.5			

Source	DF	Seq SS
Cases	1	5382.4
Distance	1	168.4

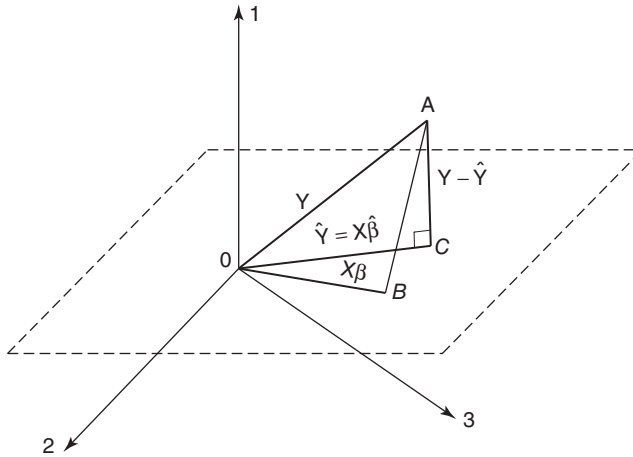

Figure 3.6 A geometrical interpretation of least squares.

sample space. These p vectors form a p -dimensional subspace called the **estimation space**. The estimation space for $p = 2$ is shown in Figure 3.6. We may represent any point in this subspace by a linear combination of the vectors $\mathbf{1}, \mathbf{x}_1, \dots, \mathbf{x}_k$. Thus, any point in the estimation space is of the form $\mathbf{X}\boldsymbol{\beta}$. Let the vector $\mathbf{X}\boldsymbol{\beta}$ determine the point B in Figure 3.6. The squared distance from B to A is just

$$S(\boldsymbol{\beta}) = (\mathbf{y} - \mathbf{X}\boldsymbol{\beta})'(\mathbf{y} - \mathbf{X}\boldsymbol{\beta})$$

Therefore, minimizing the squared distance of point A defined by the observation vector \mathbf{y} to the estimation space requires finding the point in the estimation space that is closest to A . The squared distance is a minimum when the point in the estimation space is the foot of the line from A normal (or perpendicular) to the estimation space. This is point C in Figure 3.6. This point is defined by the vector $\hat{\mathbf{y}} = \mathbf{X}\hat{\boldsymbol{\beta}}$. Therefore, since $\mathbf{y} - \hat{\mathbf{y}} = \mathbf{y} - \mathbf{X}\hat{\boldsymbol{\beta}}$ is perpendicular to the estimation space, we may write

$$\mathbf{X}'(\mathbf{y} - \mathbf{X}\hat{\boldsymbol{\beta}}) = \mathbf{0} \quad \text{or} \quad \mathbf{X}'\mathbf{X}\hat{\boldsymbol{\beta}} = \mathbf{X}'\mathbf{y}$$

which we recognize as the least-squares normal equations.

3.2.3 Properties of the Least-Squares Estimators

The statistical properties of the least-squares estimator $\hat{\boldsymbol{\beta}}$ may be easily demonstrated. Consider first bias, assuming that the model is correct:

$$\begin{aligned} E(\hat{\boldsymbol{\beta}}) &= E[(\mathbf{X}'\mathbf{X})^{-1}\mathbf{X}'\mathbf{y}] = E[(\mathbf{X}'\mathbf{X})^{-1}\mathbf{X}'(\mathbf{X}\boldsymbol{\beta} + \boldsymbol{\varepsilon})] \\ &= E[(\mathbf{X}'\mathbf{X})^{-1}\mathbf{X}'\mathbf{X}\boldsymbol{\beta} + (\mathbf{X}'\mathbf{X})^{-1}\mathbf{X}'\boldsymbol{\varepsilon}] = \boldsymbol{\beta} \end{aligned}$$

since $E(\boldsymbol{\varepsilon}) = \mathbf{0}$ and $(\mathbf{X}'\mathbf{X})^{-1}\mathbf{X}'\mathbf{X} = \mathbf{I}$. Thus, $\hat{\boldsymbol{\beta}}$ is an **unbiased estimator** of $\boldsymbol{\beta}$ if the model is correct.

The variance property of $\hat{\boldsymbol{\beta}}$ is expressed by the **covariance matrix**

$$\text{Cov}(\hat{\boldsymbol{\beta}}) = E \left\{ \left[\hat{\boldsymbol{\beta}} - E(\hat{\boldsymbol{\beta}}) \right] \left[\hat{\boldsymbol{\beta}} - E(\hat{\boldsymbol{\beta}}) \right]' \right\}$$

which is a $p \times p$ symmetric matrix whose j th diagonal element is the variance of $\hat{\beta}_j$ and whose (ij) th off-diagonal element is the covariance between $\hat{\beta}_i$ and $\hat{\beta}_j$. The covariance matrix of $\hat{\boldsymbol{\beta}}$ is found by applying a variance operator to $\hat{\boldsymbol{\beta}}$:

$$\text{Cov}(\hat{\boldsymbol{\beta}}) = \text{Var}(\hat{\boldsymbol{\beta}}) = \text{Var}[(\mathbf{X}'\mathbf{X})^{-1} \mathbf{X}'\mathbf{y}]$$

Now $(\mathbf{X}'\mathbf{X})^{-1}\mathbf{X}'$ is a matrix of constants, and the variance of \mathbf{y} is $\sigma^2\mathbf{I}$, so

$$\begin{aligned} \text{Var}(\hat{\boldsymbol{\beta}}) &= \text{Var}[(\mathbf{X}'\mathbf{X})^{-1} \mathbf{X}'\mathbf{y}] = (\mathbf{X}'\mathbf{X})^{-1} \mathbf{X}' \text{Var}(\mathbf{y}) [(\mathbf{X}'\mathbf{X})^{-1} \mathbf{X}']' \\ &= \sigma^2 (\mathbf{X}'\mathbf{X})^{-1} \mathbf{X}'\mathbf{X}(\mathbf{X}'\mathbf{X})^{-1} = \sigma^2 (\mathbf{X}'\mathbf{X})^{-1} \end{aligned}$$

Therefore, if we let $\mathbf{C} = (\mathbf{X}'\mathbf{X})^{-1}$, the variance of $\hat{\beta}_j$ is $\sigma^2 C_{jj}$ and the covariance between $\hat{\beta}_i$ and $\hat{\beta}_j$ is $\sigma^2 C_{ij}$.

Appendix C.4 establishes that the least-squares estimator $\hat{\boldsymbol{\beta}}$ is the best linear unbiased estimator of $\boldsymbol{\beta}$ (the Gauss-Markov theorem). If we further assume that the errors ε_i are normally distributed, then as we see in Section 3.2.6, $\hat{\boldsymbol{\beta}}$ is also the maximum-likelihood estimator of $\boldsymbol{\beta}$. The maximum-likelihood estimator is the minimum variance unbiased estimator of $\boldsymbol{\beta}$.

3.2.4 Estimation of σ^2

As in simple linear regression, we may develop an estimator of σ^2 from the residual sum of squares

$$SS_{\text{Res}} = \sum_{i=1}^n (y_i - \hat{y}_i)^2 = \sum_{i=1}^n e_i^2 = \mathbf{e}'\mathbf{e}$$

Substituting $\mathbf{e} = \mathbf{y} - \mathbf{X}\hat{\boldsymbol{\beta}}$, we have

$$\begin{aligned} SS_{\text{Res}} &= (\mathbf{y} - \mathbf{X}\hat{\boldsymbol{\beta}})' (\mathbf{y} - \mathbf{X}\hat{\boldsymbol{\beta}}) \\ &= \mathbf{y}'\mathbf{y} - \hat{\boldsymbol{\beta}}'\mathbf{X}'\mathbf{y} - \mathbf{y}'\mathbf{X}\hat{\boldsymbol{\beta}} + \hat{\boldsymbol{\beta}}'\mathbf{X}'\mathbf{X}\hat{\boldsymbol{\beta}} \\ &= \mathbf{y}'\mathbf{y} - 2\hat{\boldsymbol{\beta}}'\mathbf{X}'\mathbf{y} + \hat{\boldsymbol{\beta}}'\mathbf{X}'\mathbf{X}\hat{\boldsymbol{\beta}} \end{aligned}$$

Since $\mathbf{X}'\mathbf{X}\hat{\boldsymbol{\beta}} = \mathbf{X}'\mathbf{y}$, this last equation becomes

$$SS_{\text{Res}} = \mathbf{y}'\mathbf{y} - \hat{\boldsymbol{\beta}}'\mathbf{X}'\mathbf{y} \quad (3.16)$$

Appendix C.3 shows that the residual sum of squares has $n - p$ degrees of freedom associated with it since p parameters are estimated in the regression model. The **residual mean square** is

$$MS_{\text{Res}} = \frac{SS_{\text{Res}}}{n-p} \quad (3.17)$$

Appendix C.3 also shows that the expected value of MS_{Res} is σ^2 , so an **unbiased estimator** of σ^2 is given by

$$\hat{\sigma}^2 = MS_{\text{Res}} \quad (3.18)$$

As noted in the simple linear regression case, this estimator of σ^2 is **model dependent**.

Example 3.2 The Delivery Time Data

We now estimate the error variance σ^2 for the multiple regression model fit to the soft drink delivery time data in Example 3.1. Since

$$\mathbf{y}'\mathbf{y} = \sum_{i=1}^{25} y_i^2 = 18,310.6290$$

and

$$\begin{aligned} \hat{\boldsymbol{\beta}}'\mathbf{X}'\mathbf{y} &= [2.34123115 \quad 1.61590721 \quad 0.01438483] \begin{bmatrix} 559.60 \\ 7,375.44 \\ 337,072.00 \end{bmatrix} \\ &= 18,076.90304 \end{aligned}$$

the residual sum of squares is

$$\begin{aligned} SS_{\text{Res}} &= \mathbf{y}'\mathbf{y} - \hat{\boldsymbol{\beta}}'\mathbf{X}'\mathbf{y} \\ &= 18,310.6290 - 18,076.9030 = 233.7260 \end{aligned}$$

Therefore, the estimate of σ^2 is the residual mean square

$$\hat{\sigma}^2 = \frac{SS_{\text{Res}}}{n-p} = \frac{233.7260}{25-3} = 10.6239$$

The Minitab output in Table 3.4 reports the residual mean square as 10.6 ■

The model-dependent nature of this estimate $\hat{\sigma}^2$ may be easily demonstrated. Table 2.12 displays the computer output from a least-squares fit to the delivery time data using only one regressor, cases (x_1). The residual mean square for this model is 17.5, which is considerably larger than the result obtained above for the two-regressor model. Which estimate is “correct”? Both estimates are in a sense correct, but they depend heavily on the choice of model. Perhaps a better question is which **model** is correct? Since σ^2 is the variance of the errors (the unexplained noise about

the regression line), we would usually prefer a model with a small residual mean square to a model with a large one.

3.2.5 Inadequacy of Scatter Diagrams in Multiple Regression

We saw in Chapter 2 that the scatter diagram is an important tool in analyzing the relationship between y and x in simple linear regression. We also saw in Example 3.1 that a **matrix of scatterplots** was useful in visualizing the relationship between y and two regressors. It is tempting to conclude that this is a general concept; that is, examining scatter diagrams of y versus x_1 , y versus x_2 , \dots , y versus x_k is always useful in assessing the relationships between y and each of the regressors x_1, x_2, \dots, x_k . Unfortunately, this is not true in general.

Following Daniel and Wood [1980], we illustrate the inadequacy of scatter diagrams for a problem with two regressors. Consider the data shown in Figure 3.7. These data were generated from the equation

$$y = 8 - 5x_1 + 12x_2$$

The matrix of scatterplots is shown in Figure 3.7. The y -versus- x_1 plot does not exhibit any apparent relationship between the two variables. The y -versus- x_2 plot indicates that a linear relationship exists, with a slope of approximately 8. Note that both scatter diagrams convey erroneous information. Since in this data set there are two pairs of points that have the same x_2 values ($x_2 = 2$ and $x_2 = 4$), we could measure the x_1 effect at fixed x_2 from both pairs. This gives, $\hat{\beta}_1 = (17 - 27)/(3 - 1) = -5$ for $x_2 = 2$ and $\hat{\beta}_1 = (26 - 16)/(6 - 8) = -5$ for $x_2 = 4$ the correct results. Knowing $\hat{\beta}_1$, we could

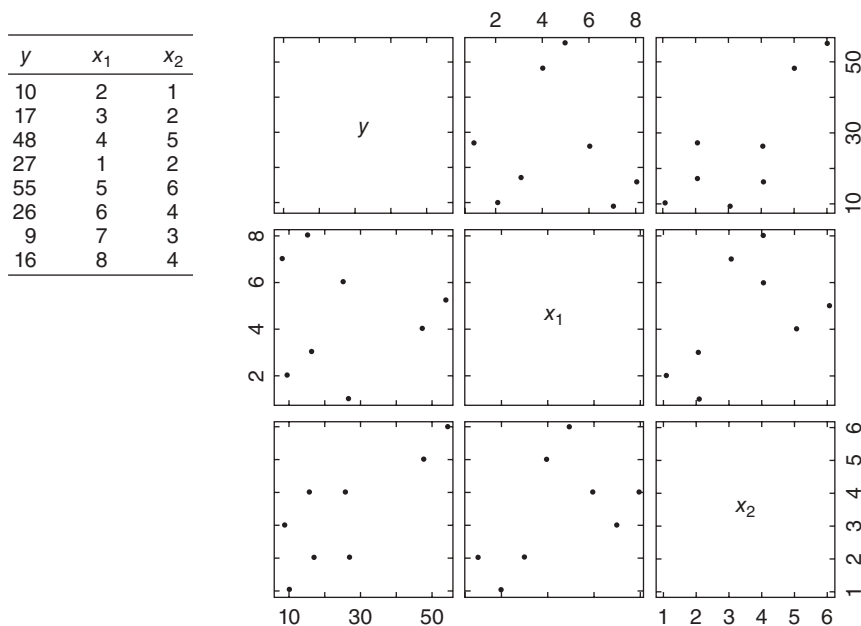

Figure 3.7 A matrix of scatterplots.

now estimate the x_2 effect. This procedure is not generally useful, however, because many data sets do not have duplicate points.

This example illustrates that constructing scatter diagrams of y versus x_j ($j = 1, 2, \dots, k$) can be misleading, even in the case of only two regressors operating in a perfectly additive fashion with no noise. A more realistic regression situation with several regressors and error in the y 's would confuse the situation even further. If there is only one (or a few) dominant regressor, or if the regressors operate nearly independently, the matrix of scatterplots is most useful. However, when several important regressors are themselves interrelated, then these scatter diagrams can be very misleading. Analytical methods for sorting out the relationships between several regressors and a response are discussed in Chapter 10.

3.2.6 Maximum-Likelihood Estimation

Just as in the simple linear regression case, we can show that the maximum-likelihood estimators for the model parameters in multiple linear regression when the model errors are normally and independently distributed are also least-squares estimators. The model is

$$\mathbf{y} = \mathbf{X}\boldsymbol{\beta} + \boldsymbol{\varepsilon}$$

and the errors are normally and independently distributed with constant variance σ^2 , or $\boldsymbol{\varepsilon}$ is distributed as $N(\mathbf{0}, \sigma^2\mathbf{I})$. The normal density function for the errors is

$$f(\varepsilon_i) = \frac{1}{\sigma\sqrt{2\pi}} \exp\left(-\frac{1}{2\sigma^2}\varepsilon_i^2\right)$$

The likelihood function is the joint density of $\varepsilon_1, \varepsilon_2, \dots, \varepsilon_n$ or $\prod_{i=1}^n f(\varepsilon_i)$. Therefore, the likelihood function is

$$L(\boldsymbol{\varepsilon}, \boldsymbol{\beta}, \sigma^2) = \prod_{i=1}^n f(\varepsilon_i) = \frac{1}{(2\pi)^{n/2} \sigma^n} \exp\left(-\frac{1}{2\sigma^2} \boldsymbol{\varepsilon}'\boldsymbol{\varepsilon}\right)$$

Now since we can write $\boldsymbol{\varepsilon} = \mathbf{y} - \mathbf{X}\boldsymbol{\beta}$, the likelihood function becomes

$$L(\mathbf{y}, \mathbf{X}, \boldsymbol{\beta}, \sigma^2) = \frac{1}{(2\pi)^{n/2} \sigma^n} \exp\left(-\frac{1}{2\sigma^2} (\mathbf{y} - \mathbf{X}\boldsymbol{\beta})'(\mathbf{y} - \mathbf{X}\boldsymbol{\beta})\right) \quad (3.19)$$

As in the simple linear regression case, it is convenient to work with the log of the likelihood,

$$\ln L(\mathbf{y}, \mathbf{X}, \boldsymbol{\beta}, \sigma^2) = -\frac{n}{2} \ln(2\pi) - n \ln(\sigma) - \frac{1}{2\sigma^2} (\mathbf{y} - \mathbf{X}\boldsymbol{\beta})'(\mathbf{y} - \mathbf{X}\boldsymbol{\beta})$$

It is clear that for a fixed value of σ the log-likelihood is maximized when the term

$$(\mathbf{y} - \mathbf{X}\boldsymbol{\beta})'(\mathbf{y} - \mathbf{X}\boldsymbol{\beta})$$

is minimized. Therefore, the maximum-likelihood estimator of $\boldsymbol{\beta}$ under normal errors is equivalent to the least-squares estimator $\hat{\boldsymbol{\beta}} = (\mathbf{X}'\mathbf{X})^{-1}\mathbf{X}'\mathbf{y}$. The maximum-likelihood estimator of σ^2 is

$$\tilde{\sigma}^2 = \frac{(\mathbf{y} - \mathbf{X}\hat{\boldsymbol{\beta}})'(\mathbf{y} - \mathbf{X}\hat{\boldsymbol{\beta}})}{n} \quad (3.20)$$

These are multiple linear regression generalizations of the results given for simple linear regression in Section 2.11. The statistical properties of the maximum-likelihood estimators are summarized in Section 2.11.

3.3 HYPOTHESIS TESTING IN MULTIPLE LINEAR REGRESSION

Once we have estimated the parameters in the model, we face two immediate questions:

1. What is the overall adequacy of the model?
2. Which specific regressors seem important?

Several hypothesis testing procedures prove useful for addressing these questions. The formal tests require that our random errors be independent and follow a normal distribution with mean $E(\varepsilon_i) = 0$ and variance $\text{Var}(\varepsilon_i) = \sigma^2$.

3.3.1 Test for Significance of Regression

The test for **significance of regression** is a test to determine if there is a **linear relationship** between the response y and any of the regressor variables x_1, x_2, \dots, x_k . This procedure is often thought of as an overall or global test of model adequacy. The appropriate hypotheses are

$$\begin{aligned} H_0: \beta_1 = \beta_2 = \dots = \beta_k = 0 \\ H_1: \beta_j \neq 0 \quad \text{for at least one } j \end{aligned}$$

Rejection of this null hypothesis implies that at least one of the regressors x_1, x_2, \dots, x_k contributes significantly to the model.

The test procedure is a generalization of the **analysis of variance** used in simple linear regression. The **total sum of squares** SS_T is partitioned into a **sum of squares due to regression**, SS_R , and a **residual sum of squares**, SS_{Res} . Thus,

$$SS_T = SS_R + SS_{\text{Res}}$$

Appendix C.3 shows that if the null hypothesis is true, then SS_R/σ^2 follows a χ_k^2 distribution, which has the same number of degrees of freedom as number of regressor variables in the model. Appendix C.3 also shows that $SS_{\text{Res}}/\sigma^2 \sim \chi_{n-k-1}^2$ and that SS_{Res} and SS_R are independent. By the definition of an F statistic given in Appendix C.1,

$$F_0 = \frac{SS_R/k}{SS_{Res}/(n-k-1)} = \frac{MS_R}{MS_{Res}}$$

follows the $F_{k, n-k-1}$ distribution. Appendix C.3 shows that

$$E(MS_{Res}) = \sigma^2$$

$$E(MS_R) = \sigma^2 + \frac{\boldsymbol{\beta}^{*\prime} \mathbf{X}'_c \mathbf{X}_c \boldsymbol{\beta}^*}{k\sigma^2}$$

where $\boldsymbol{\beta}^* = (\beta_1, \beta_2, \dots, \beta_k)'$ and \mathbf{X}_c is the “centered” model matrix given by

$$\mathbf{X}_c = \begin{bmatrix} x_{11} - \bar{x}_1 & x_{12} - \bar{x}_2 & \cdots & x_{1k} - \bar{x}_k \\ x_{21} - \bar{x}_1 & x_{22} - \bar{x}_2 & \cdots & x_{2k} - \bar{x}_k \\ \vdots & \vdots & & \vdots \\ x_{i1} - \bar{x}_1 & x_{i2} - \bar{x}_2 & \cdots & x_{ik} - \bar{x}_k \\ \vdots & \vdots & & \vdots \\ x_{n1} - \bar{x}_1 & x_{n2} - \bar{x}_2 & \cdots & x_{nk} - \bar{x}_k \end{bmatrix}$$

These expected mean squares indicate that if the observed value of F_0 is large, then it is likely that at least one $\beta_j \neq 0$. Appendix C.3 also shows that if at least one $\beta_j \neq 0$, then F_0 follows a noncentral F distribution with k and $n - k - 1$ degrees of freedom and a noncentrality parameter of

$$\lambda = \frac{\boldsymbol{\beta}^{*\prime} \mathbf{X}'_c \mathbf{X}_c \boldsymbol{\beta}^*}{\sigma^2}$$

This noncentrality parameter also indicates that the observed value of F_0 should be large if at least one $\beta_j \neq 0$. Therefore, to test the hypothesis $H_0: \beta_1 = \beta_2 = \dots = \beta_k = 0$, compute the test statistic F_0 and reject H_0 if

$$F_0 > F_{\alpha, k, n-k-1}$$

The test procedure is usually summarized in an **analysis-of-variance table** such as Table 3.5.

A computational formula for SS_R is found by starting with

$$SS_{Res} = \mathbf{y}'\mathbf{y} - \hat{\boldsymbol{\beta}}\mathbf{X}'\mathbf{y} \tag{3.21}$$

TABLE 3.5 Analysis of Variance for Significance of Regression in Multiple Regression

Source of Variation	Sum of Squares	Degrees of Freedom	Mean Square	F_0
Regression	SS_R	k	MS_R	MS_R/MS_{Res}
Residual	SS_{Res}	$n - k - 1$	MS_{Res}	
Total	SS_T	$n - 1$		

and since

$$SS_T = \sum_{i=1}^n y_i^2 - \frac{\left(\sum_{i=1}^n y_i\right)^2}{n} = \mathbf{y}'\mathbf{y} - \frac{\left(\sum_{i=1}^n y_i\right)^2}{n}$$

we may rewrite the above equation as

$$SS_{\text{Res}} = \mathbf{y}'\mathbf{y} - \frac{\left(\sum_{i=1}^n y_i\right)^2}{n} - \left[\hat{\boldsymbol{\beta}}'\mathbf{X}'\mathbf{y} - \frac{\left(\sum_{i=1}^n y_i\right)^2}{n} \right] \quad (3.22)$$

or

$$SS_{\text{Res}} = SS_T - SS_R \quad (3.23)$$

Therefore, the **regression sum of squares** is

$$SS_R = \hat{\boldsymbol{\beta}}'\mathbf{X}'\mathbf{y} - \frac{\left(\sum_{i=1}^n y_i\right)^2}{n} \quad (3.24)$$

the **residual sum of squares** is

$$SS_{\text{Res}} = \mathbf{y}'\mathbf{y} - \hat{\boldsymbol{\beta}}'\mathbf{X}'\mathbf{y} \quad (3.25)$$

and the **total sum of squares** is

$$SS_T = \mathbf{y}'\mathbf{y} - \frac{\left(\sum_{i=1}^n y_i\right)^2}{n} \quad (3.26)$$

Example 3.3 The Delivery Time Data

We now test for significance of regression using the delivery time data from Example 3.1. Some of the numerical quantities required are calculated in Example 3.2. Note that

$$\begin{aligned} SS_T &= \mathbf{y}'\mathbf{y} - \frac{\left(\sum_{i=1}^n y_i\right)^2}{n} \\ &= 18,310.6290 - \frac{(559.60)^2}{25} = 5784.5426 \end{aligned}$$

$$\begin{aligned}
 SS_R &= \hat{\beta}'\mathbf{X}'\mathbf{y} - \frac{\left(\sum_{i=1}^n y_i\right)^2}{n} \\
 &= 18,076.9030 - \frac{(559.60)^2}{25} = 5550.8166
 \end{aligned}$$

and

$$\begin{aligned}
 SS_{Res} &= SS_T - SS_R \\
 &= \mathbf{y}'\mathbf{y} - \hat{\beta}'\mathbf{X}'\mathbf{y} = 233.7260
 \end{aligned}$$

The analysis of variance is shown in Table 3.6. To test $H_0: \beta_1 = \beta_2 = 0$, we calculate the statistic

$$F_0 = \frac{MS_R}{MS_{Res}} = \frac{2775.4083}{10.6239} = 261.24$$

Since the P value is very small, we conclude that delivery time is related to delivery volume and/or distance. However, this does not necessarily imply that the relationship found is an appropriate one for predicting delivery time as a function of volume and distance. Further tests of model adequacy are required. ■

Minitab Output The MINITAB output in Table 3.4 also presents the analysis of variance for testing significance of regression. Apart from rounding, the results are in agreement with those reported in Table 3.6.

R^2 and Adjusted R^2 Two other ways to assess the overall adequacy of the model are R^2 and the adjusted R^2 , denoted R^2_{Adj} . The MINITAB output in Table 3.4 reports the R^2 for the multiple regression model for the delivery time data as $R^2 = 0.96$, or 96.0%. In Example 2.9, where only the single regressor x_1 (cases) was used, the value of R^2 was smaller, namely $R^2 = 0.93$, or 93.0% (see Table 2.12). In general, R^2 never decreases when a regressor is added to the model, regardless of the value of the contribution of that variable. Therefore, it is difficult to judge whether an increase in R^2 is really telling us anything important.

Some regression model builders prefer to use an **adjusted R^2** statistic, defined as

$$R^2_{Adj} = 1 - \frac{SS_{Res}/(n-p)}{SS_T/(n-1)} \tag{3.27}$$

TABLE 3.6 Test for Significance of Regression for Example 3.3

Source Variation	Sum of Squares	Degrees of Freedom	Mean Square	F_0	P Value
Regression	5550.8166	2	2775.4083	261.24	4.7×10^{-16}
Residual	233.7260	22	10.6239		
Total	5784.5426	24			

Since $SS_{\text{Res}}/(n-p)$ is the residual mean square and $SS_{\text{T}}/(n-1)$ is constant regardless of how many variables are in the model, R_{Adj}^2 will only increase on adding a variable to the model if the addition of the variable reduces the residual mean square. Minitab (Table 3.4) reports $R_{\text{Adj}}^2 = 0.956$ (95.6%) for the two-variable model, while for the simple linear regression model with only x_1 (cases), $R_{\text{Adj}}^2 = 0.927$, or 92.7% (see Table 2.12). Therefore, we would conclude that adding x_2 (distance) to the model did result in a meaningful reduction of total variability.

In subsequent chapters, when we discuss **model building** and **variable selection**, it is frequently helpful to have a procedure that can guard against **overfitting the model**, that is, adding terms that are unnecessary. The adjusted R^2 penalizes us for adding terms that are not helpful, so it is very useful in evaluating and comparing candidate regression models.

3.3.2 Tests on Individual Regression Coefficients and Subsets of Coefficients

Once we have determined that at least one of the regressors is important, a logical question becomes which one(s). Adding a variable to a regression model always causes the sum of squares for regression to increase and the residual sum of squares to decrease. We must decide whether the increase in the regression sum of squares is sufficient to warrant using the additional regressor in the model. The addition of a regressor also increases the variance of the fitted value \hat{y} , so we must be careful to include only regressors that are of real value in explaining the response. Furthermore, adding an unimportant regressor may increase the residual mean square, which may decrease the usefulness of the model.

The hypotheses for testing the significance of any individual regression coefficient, such as β_j , are

$$H_0: \beta_j = 0, \quad H_1: \beta_j \neq 0 \quad (3.28)$$

If $H_0: \beta_j = 0$ is not rejected, then this indicates that the regressor x_j can be deleted from the model. The **test statistic** for this hypothesis is

$$t_0 = \frac{\hat{\beta}_j}{\sqrt{\hat{\sigma}^2 C_{jj}}} = \frac{\hat{\beta}_j}{\text{se}(\hat{\beta}_j)} \quad (3.29)$$

where C_{jj} is the diagonal element of $(\mathbf{X}'\mathbf{X})^{-1}$ corresponding to $\hat{\beta}_j$. The null hypothesis $H_0: \beta_j = 0$ is rejected if $|t_0| > t_{\alpha/2, n-k-1}$. Note that this is really a **partial** or **marginal test** because the regression coefficient $\hat{\beta}_j$ depends on all of the other regressor variables $x_i (i \neq j)$ that are in the model. Thus, this is a test of the **contribution** of x_j **given the other regressors in the model**.

Example 3.4 The Delivery Time Data

To illustrate the procedure, consider the delivery time data in Example 3.1. Suppose we wish to assess the value of the regressor variable x_2 (distance) given that the regressor x_1 (cases) is in the model. The hypotheses are

$$H_0: \beta_2 = 0, \quad H_1: \beta_2 \neq 0$$

The main diagonal element of $(\mathbf{X}'\mathbf{X})^{-1}$ corresponding to β_2 is $C_{22} = 0.00000123$, so the t statistic (3.29) becomes

$$t_0 = \frac{\hat{\beta}_2}{\sqrt{\hat{\sigma}^2 C_{22}}} = \frac{0.01438}{\sqrt{(10.6239)(0.00000123)}} = 3.98$$

Since $t_{0.025,22} = 2.074$, we reject $H_0: \beta_2 = 0$ and conclude that the regressor x_2 (distance) contributes significantly to the model given that x_1 (cases) is also in the model. This t test is also provided in the Minitab output (Table 3.4), and the P value reported is 0.001. ■

We may also directly determine the contribution to the regression sum of squares of a regressor, for example, x_j , given that other regressors $x_i (i \neq j)$ are included in the model by using the **extra-sum-of-squares method**. This procedure can also be used to investigate the contribution of a **subset** of the regressor variables to the model.

Consider the regression model with k regressors

$$\mathbf{y} = \mathbf{X}\boldsymbol{\beta} + \boldsymbol{\varepsilon}$$

where y is $n \times 1$, \mathbf{X} is $n \times p$, $\boldsymbol{\beta}$ is $p \times 1$, $\boldsymbol{\varepsilon}$ is $n \times 1$, and $p = k + 1$. We would like to determine if some subset of $r < k$ regressors contributes significantly to the regression model. Let the vector of regression coefficients be partitioned as follows:

$$\boldsymbol{\beta} = \begin{bmatrix} \boldsymbol{\beta}_1 \\ \boldsymbol{\beta}_2 \end{bmatrix}$$

where $\boldsymbol{\beta}_1$ is $(p - r) \times 1$ and $\boldsymbol{\beta}_2$ is $r \times 1$. We wish to test the hypotheses

$$H_0: \boldsymbol{\beta}_2 = \mathbf{0}, \quad H_1: \boldsymbol{\beta}_2 \neq \mathbf{0} \tag{3.30}$$

The model may be written as

$$\mathbf{y} = \mathbf{X}\boldsymbol{\beta} + \boldsymbol{\varepsilon} = \mathbf{X}_1\boldsymbol{\beta}_1 + \mathbf{X}_2\boldsymbol{\beta}_2 + \boldsymbol{\varepsilon} \tag{3.31}$$

where the $n \times (p - r)$ matrix \mathbf{X}_1 represents the columns of \mathbf{X} associated with $\boldsymbol{\beta}_1$ and the $n \times r$ matrix \mathbf{X}_2 represents the columns of \mathbf{X} associated with $\boldsymbol{\beta}_2$. This is called the **full model**.

For the full model, we know that $\hat{\boldsymbol{\beta}} = (\mathbf{X}'\mathbf{X})^{-1} \mathbf{X}'\mathbf{y}$. The regression sum of squares for this model is

$$SS_R(\boldsymbol{\beta}) = \hat{\boldsymbol{\beta}}'\mathbf{X}'\mathbf{y} \quad (p \text{ degrees of freedom})$$

and

$$MS_{Res} = \frac{\mathbf{y}'\mathbf{y} - \hat{\boldsymbol{\beta}}'\mathbf{X}'\mathbf{y}}{n - p}$$

To find the contribution of the terms in β_2 to the regression, fit the model assuming that the null hypothesis $H_0: \beta_2 = \mathbf{0}$ is true. This **reduced model** is

$$\mathbf{y} = \mathbf{X}_1\beta_1 + \varepsilon \quad (3.32)$$

The least-squares estimator of β_1 in the reduced model is $\hat{\beta}_1 = (\mathbf{X}'_1\mathbf{X}_1)^{-1}\mathbf{X}'_1\mathbf{y}$. The regression sum of squares is

$$SS_R(\beta_1) = \hat{\beta}'_1\mathbf{X}'_1\mathbf{y} \quad (p-r \text{ degrees of freedom}) \quad (3.33)$$

The regression sum of squares due to β_2 given that β_1 is already in the model is

$$SS_R(\beta_2|\beta_1) = SS_R(\beta) - SS_R(\beta_1) \quad (3.34)$$

with $p - (p - r) = r$ degrees of freedom. This sum of squares is called the **extra sum of squares due to β_2** because it measures the increase in the regression sum of squares that results from adding the regressors $x_{k-r+1}, x_{k-r+2}, \dots, x_k$ to a model that already contains x_1, x_2, \dots, x_{k-r} . Now $SS_R(\beta_2|\beta_1)$ is independent of MS_{Res} , and the null hypothesis $\beta_2 = \mathbf{0}$ may be tested by the statistic

$$F_0 = \frac{SS_R(\beta_2|\beta_1)/r}{MS_{Res}} \quad (3.35)$$

If $\beta_2 \neq \mathbf{0}$, then F_0 follows a noncentral F distribution with a noncentrality parameter of

$$\lambda = \frac{1}{\sigma^2} \beta'_2\mathbf{X}'_2[\mathbf{I} - \mathbf{X}_1(\mathbf{X}'_1\mathbf{X}_1)^{-1}\mathbf{X}'_1]\mathbf{X}_2\beta_2$$

This result is quite important. If there is multicollinearity in the data, there are situations where β_2 is markedly nonzero, but this test actually has almost no power (ability to indicate this difference) because of a near-collinear relationship between \mathbf{X}_1 and \mathbf{X}_2 . In this situation, λ is nearly zero even though β_2 is truly important. This relationship also points out that the maximal power for this test occurs when \mathbf{X}_1 and \mathbf{X}_2 are orthogonal to one another. By orthogonal we mean that $\mathbf{X}'_2\mathbf{X}_1 = \mathbf{0}$.

If $F_0 > F_{\alpha, r, n-p}$, we reject H_0 , concluding that at least one of the parameters in β_2 is not zero, and consequently at least one of the regressors $x_{k-r+1}, x_{k-r+2}, \dots, x_k$ in \mathbf{X}_2 contribute significantly to the regression model. Some authors call the test in (3.35) a **partial F test** because it measures the contribution of the regressors in \mathbf{X}_2 given that the other regressors in \mathbf{X}_1 are in the model. To illustrate the usefulness of this procedure, consider the model

$$y = \beta_0 + \beta_1x_1 + \beta_2x_2 + \beta_3x_3 + \varepsilon$$

The sums of squares

$$SS_R(\beta_1|\beta_0, \beta_2, \beta_3), \quad SS_R(\beta_2|\beta_0, \beta_1, \beta_3), \quad SS_R(\beta_3|\beta_0, \beta_1, \beta_2)$$

are single-degree-of-freedom sums of squares that measure the contribution of each regressor x_j , $j = 1, 2, 3$, to the model given that all of the other regressors were already in the model. That is, we are assessing the value of adding x_j to a model that did not include this regressor. In general, we could find

$$SS_R(\beta_j | \beta_0, \beta_1, \dots, \beta_{j-1}, \beta_{j+1}, \dots, \beta_k), \quad 1 \leq j \leq k$$

which is the increase in the regression sum of squares due to adding x_j to a model that already contains $x_1, \dots, x_{j-1}, x_{j+1}, \dots, x_k$. Some find it helpful to think of this as measuring the **contribution of x_j as if it were the last variable added to the model**.

Appendix C3.35 formally shows the equivalence of the partial F test on a single variable x_j and the t test in (3.29). However, the partial F test is a more general procedure in that we can measure the effect of **sets** of variables. In Chapter 10 we will show how the partial F test plays a major role in **model building**, that is, in searching for the best set of regressors to use in the model.

The extra-sum-of-squares method can be used to test hypotheses about any **subset** of regressor variables that seems reasonable for the particular problem under analysis. Sometimes we find that there is a natural hierarchy or ordering in the regressors, and this forms the basis of a test. For example, consider the quadratic polynomial

$$y = \beta_0 + \beta_1 x_1 + \beta_2 x_2 + \beta_{12} x_1 x_2 + \beta_{11} x_1^2 + \beta_{22} x_2^2 + \varepsilon$$

Here we might be interested in finding

$$SS_R(\beta_1, \beta_2 | \beta_0)$$

which would measure the contribution of the first-order terms to the model, and

$$SS_R(\beta_{12}, \beta_{11}, \beta_{22} | \beta_0, \beta_1, \beta_2)$$

which would measure the contribution of adding second-order terms to a model that already contained first-order terms.

When we think of adding regressors one at a time to a model and examining the contribution of the regressor added at each step given all regressors added previously, we can partition the regression sum of squares into marginal single-degree-of-freedom components. For example, consider the model

$$y = \beta_0 + \beta_1 x_1 + \beta_2 x_2 + \beta_3 x_3 + \varepsilon$$

with the corresponding analysis-of-variance identity

$$SS_T = SS_R(\beta_1, \beta_2, \beta_3 | \beta_0) + SS_{Res}$$

We may decompose the three-degree-of-freedom regression sum of squares as follows:

$$SS_R(\beta_1, \beta_2, \beta_3 | \beta_0) = SS_R(\beta_1 | \beta_0) + SS_R(\beta_2 | \beta_1, \beta_1) + SS_R(\beta_3 | \beta_1, \beta_2, \beta_0)$$

where each sum of squares on the right-hand side has one degree of freedom. Note that the order of the regressors in these marginal components is arbitrary. An alternate partitioning of $SS_R(\beta_1, \beta_2, \beta_3|\beta_0)$ is

$$SS_R(\beta_1, \beta_2, \beta_3|\beta_0) = SS_R(\beta_2|\beta_0) + SS_R(\beta_1|\beta_2, \beta_0) + SS_R(\beta_3|\beta_1, \beta_2, \beta_0)$$

However, the extra-sum-of-squares method does not always produce a partitioning of the regression sum of squares, since, in general,

$$SS_R(\beta_1, \beta_2, \beta_3|\beta_0) \neq SS_R(\beta_1|\beta_2, \beta_3, \beta_0) + SS_R(\beta_2|\beta_1, \beta_3, \beta_0) + SS_R(\beta_3|\beta_1, \beta_2, \beta_0)$$

Minitab Output The Minitab output in Table 3.4 provides a sequential partitioning of the regression sum of squares for $x_1 = \text{cases}$ and $x_2 = \text{distance}$. The reported quantities are

$$\begin{aligned} SS_R(\beta_1, \beta_2|\beta_0) &= SS_R(\beta_1|\beta_0) + SS_R(\beta_1, \beta_2|\beta_0) \\ 5550.8 &= 5382.4 + 168.4 \end{aligned}$$

Example 3.5 The Delivery Time Data

Consider the soft drink delivery time data in Example 3.1. Suppose that we wish to investigate the contribution of the variable distance (x_2) to the model. The appropriate hypotheses are

$$H_0: \beta_2 = 0, \quad H_1: \beta_2 \neq 0$$

To test these hypotheses, we need the extra sum of squares due to β_2 , or

$$\begin{aligned} SS_R(\beta_2|\beta_1, \beta_0) &= SS_R(\beta_1, \beta_2, \beta_0) - SS_R(\beta_1, \beta_0) \\ &= SS_R(\beta_1, \beta_2|\beta_0) - SS_R(\beta_1|\beta_0) \end{aligned}$$

From Example 3.3 we know that

$$SS_R(\beta_1, \beta_2|\beta_0) = \hat{\beta}'\mathbf{X}'\mathbf{y} - \frac{\left(\sum_{i=1}^n y_i\right)^2}{n} = 5550.8166 \text{ (2 degrees of freedom)}$$

The reduced model $y = \beta_0 + \beta_1 x_1 + \varepsilon$ was fit in Example 2.9, resulting in $\hat{y} = 3.3208 + 2.1762x_1$. The regression sum of squares for this model is

$$\begin{aligned} SS_R(\beta_1|\beta_0) &= \hat{\beta}_1 S_{xy} = (2.1762)(2473.3440) \\ &= 5382.4077 \text{ (1 degree of freedom)} \end{aligned}$$

Therefore, we have

$$\begin{aligned} SS_R(\beta_2|\beta_1, \beta_0) &= 5550.8166 - 5382.4088 \\ &= 168.4078 \text{ (1 degree of freedom)} \end{aligned}$$

This is the increase in the regression sum of squares that results from adding x_2 to a model already containing x_1 . To test $H_0: \beta_2 = 0$, form the test statistic

$$F_0 = \frac{SS_R(\beta_2|\beta_1, \beta_0)/1}{MS_{Res}} = \frac{168.4078/1}{10.6239} = 15.85$$

Note that the MS_{Res} from the **full** model using both x_1 and x_2 is used in the denominator of the test statistic. Since $F_{0.05,1,22} = 4.30$, we reject $H_0: \beta_2 = 0$ and conclude that distance (x_2) contributes significantly to the model.

Since this partial F test involves a single variable, it is equivalent to the t test. To see this, recall that the t test on $H_0: \beta_2 = 0$ resulted in the test statistic $t_0 = 3.98$. From Section C.1, the square of a t random variable with ν degrees of freedom is an F random variable with one numerator and ν denominator degrees of freedom, and we have $t_0^2 = (3.98)^2 = 15.84 \approx F_0$. ■

3.3.3 Special Case of Orthogonal Columns in \mathbf{X}

Consider the model (3.31)

$$\begin{aligned} \mathbf{y} &= \mathbf{X}\boldsymbol{\beta} + \boldsymbol{\varepsilon} \\ &= \mathbf{X}_1\boldsymbol{\beta}_1 + \mathbf{X}_2\boldsymbol{\beta}_2 + \boldsymbol{\varepsilon} \end{aligned}$$

The extra-sum-of-squares method allows us to measure the effect of the regressors in \mathbf{X}_2 conditional on those in \mathbf{X}_1 by computing $SS_R(\beta_2|\beta_1)$. In general, we cannot talk about finding the sum of squares due to β_2 , $SS_R(\beta_2)$, without accounting for the dependence of this quantity on the regressors in \mathbf{X}_1 . However, if the columns in \mathbf{X}_1 are **orthogonal** to the columns in \mathbf{X}_2 , we can determine a sum of squares due to β_2 that is free of any dependence on the regressors in \mathbf{X}_1 .

To demonstrate this, form the normal equations $(\mathbf{X}'\mathbf{X})\hat{\boldsymbol{\beta}} = \mathbf{X}'\mathbf{y}$ for the model (3.31). The normal equations are

$$\begin{bmatrix} \mathbf{X}'_1\mathbf{X}_1 & \mathbf{X}'_1\mathbf{X}_2 \\ \mathbf{X}'_2\mathbf{X}_1 & \mathbf{X}'_2\mathbf{X}_2 \end{bmatrix} \begin{bmatrix} \hat{\boldsymbol{\beta}}_1 \\ \hat{\boldsymbol{\beta}}_2 \end{bmatrix} = \begin{bmatrix} \mathbf{X}'_1\mathbf{y} \\ \mathbf{X}'_2\mathbf{y} \end{bmatrix}$$

Now if the columns of \mathbf{X}_1 are orthogonal to the columns in \mathbf{X}_2 , $\mathbf{X}'_1\mathbf{X}_2 = \mathbf{0}$ and $\mathbf{X}'_2\mathbf{X}_1 = \mathbf{0}$. Then the normal equations become

$$\mathbf{X}'_1\mathbf{X}_1\hat{\boldsymbol{\beta}}_1 = \mathbf{X}'_1\mathbf{y}, \quad \mathbf{X}'_2\mathbf{X}_2\hat{\boldsymbol{\beta}}_2 = \mathbf{X}'_2\mathbf{y}$$

with solution

$$\hat{\boldsymbol{\beta}}_1 = (\mathbf{X}'_1\mathbf{X}_1)^{-1} \mathbf{X}'_1\mathbf{y}, \quad \hat{\boldsymbol{\beta}}_2 = (\mathbf{X}'_2\mathbf{X}_2)^{-1} \mathbf{X}'_2\mathbf{y}$$

Note that the least-squares estimator of β_1 is $\hat{\boldsymbol{\beta}}_1$ regardless of whether or not \mathbf{X}_2 is in the model, and the least-squares estimator of β_2 is $\hat{\boldsymbol{\beta}}_2$ regardless of whether or not \mathbf{X}_1 is in the model.

The regression sum of squares for the full model is

$$\begin{aligned}
 SS_R(\boldsymbol{\beta}) &= \hat{\boldsymbol{\beta}}' \mathbf{X}' \mathbf{y} \\
 &= \begin{bmatrix} \hat{\boldsymbol{\beta}}_1' & \hat{\boldsymbol{\beta}}_2' \end{bmatrix} \begin{bmatrix} \mathbf{X}'_1 \mathbf{y} \\ \mathbf{X}'_2 \mathbf{y} \end{bmatrix} \\
 &= \hat{\boldsymbol{\beta}}_1' \mathbf{X}'_1 \mathbf{y} + \hat{\boldsymbol{\beta}}_2' \mathbf{X}'_2 \mathbf{y} \\
 &= \mathbf{y}' \mathbf{X}_1 (\mathbf{X}'_1 \mathbf{X}_1)^{-1} \mathbf{X}'_1 \mathbf{y} + \mathbf{y}' \mathbf{X}_2 (\mathbf{X}'_2 \mathbf{X}_2)^{-1} \mathbf{X}'_2 \mathbf{y}
 \end{aligned} \tag{3.36}$$

However, the normal equations form two sets, and for each set we note that

$$\begin{aligned}
 SS_R(\boldsymbol{\beta}_1) &= \hat{\boldsymbol{\beta}}_1' \mathbf{X}'_1 \mathbf{y} = \mathbf{y}' \mathbf{X}_1 (\mathbf{X}'_1 \mathbf{X}_1)^{-1} \mathbf{X}'_1 \mathbf{y} \\
 SS_R(\boldsymbol{\beta}_2) &= \hat{\boldsymbol{\beta}}_2' \mathbf{X}'_2 \mathbf{y} = \mathbf{y}' \mathbf{X}_2 (\mathbf{X}'_2 \mathbf{X}_2)^{-1} \mathbf{X}'_2 \mathbf{y}
 \end{aligned} \tag{3.37}$$

Comparing Eq. (3.37) with Eq. (3.36), we see that

$$SS_R(\boldsymbol{\beta}) = SS_R(\boldsymbol{\beta}_1) + SS_R(\boldsymbol{\beta}_2) \tag{3.38}$$

Therefore,

$$SS_R(\boldsymbol{\beta}_1 | \boldsymbol{\beta}_2) = SS_R(\boldsymbol{\beta}) - SS_R(\boldsymbol{\beta}_2) \equiv SS_R(\boldsymbol{\beta}_1)$$

and

$$SS_R(\boldsymbol{\beta}_2 | \boldsymbol{\beta}_1) = SS_R(\boldsymbol{\beta}) - SS_R(\boldsymbol{\beta}_1) \equiv SS_R(\boldsymbol{\beta}_2)$$

Consequently, $SS_R(\boldsymbol{\beta}_1)$ measures the contribution of the regressors in \mathbf{X}_1 to the model **unconditionally**, and $SS_R(\boldsymbol{\beta}_2)$ measures the contribution of the regressors in \mathbf{X}_2 to the model **unconditionally**. Because we can unambiguously determine the effect of each regressor when the regressors are orthogonal, data collection experiments are often designed to have orthogonal variables.

As an example of a regression model with orthogonal regressors, consider the model $y = \beta_0 + \beta_1 x_1 + \beta_2 x_2 + \beta_3 x_3 + \varepsilon$, where the \mathbf{X} matrix is

$$\mathbf{X} = \begin{matrix} & \begin{matrix} \beta_0 & \beta_1 & \beta_2 & \beta_3 \end{matrix} \\ \begin{bmatrix} 1 & -1 & -1 & -1 \\ 1 & 1 & -1 & -1 \\ 1 & -1 & 1 & -1 \\ 1 & -1 & -1 & 1 \\ 1 & 1 & 1 & -1 \\ 1 & 1 & -1 & 1 \\ 1 & -1 & 1 & 1 \\ 1 & 1 & 1 & 1 \end{bmatrix} & \end{matrix}$$

The levels of the regressors correspond to the 2^3 factorial design. It is easy to see that the columns of \mathbf{X} are orthogonal. Thus, $SS_R(\beta_j), j = 1, 2, 3$, measures the contribution of the regressor x_j to the model regardless of whether any of the other regressors are included in the fit.

3.3.4 Testing the General Linear Hypothesis

Many hypotheses about regression coefficients can be tested using a unified approach. The extra-sum-of-squares method is a special case of this procedure. In the more general procedure the sum of squares used to test the hypothesis is usually calculated as the difference between two residual sums of squares. We will now outline the procedure. For proofs and further discussion, refer to Graybill [1976], Searle [1971], or Seber [1977].

Suppose that the null hypothesis of interest can be expressed as $H_0: \mathbf{T}\boldsymbol{\beta} = \mathbf{0}$, where \mathbf{T} is an $m \times p$ matrix of constants, such that only r of the m equations in $\mathbf{T}\boldsymbol{\beta} = \mathbf{0}$ are independent. The **full model** is $\mathbf{y} = \mathbf{X}\boldsymbol{\beta} + \boldsymbol{\varepsilon}$, with $\hat{\boldsymbol{\beta}} = (\mathbf{X}'\mathbf{X})^{-1}\mathbf{X}'\mathbf{y}$, and the residual sum of squares for the full model is

$$SS_{\text{Res}}(FM) = \mathbf{y}'\mathbf{y} - \hat{\boldsymbol{\beta}}'\mathbf{X}'\mathbf{y} \quad (n - p \text{ degrees of freedom})$$

To obtain the **reduced model**, the r independent equations in $\mathbf{T}\boldsymbol{\beta} = \mathbf{0}$ are used to solve for r of the regression coefficients in the full model in terms of the remaining $p - r$ regression coefficients. This leads to the reduced model $\mathbf{y} = \mathbf{Z}\boldsymbol{\gamma} + \boldsymbol{\varepsilon}$, for example, where \mathbf{Z} is an $n \times (p - r)$ matrix and $\boldsymbol{\gamma}$ is a $(p - r) \times 1$ vector of unknown regression coefficients. The estimate of $\boldsymbol{\gamma}$ is

$$\hat{\boldsymbol{\gamma}} = (\mathbf{Z}'\mathbf{Z})^{-1}\mathbf{Z}'\mathbf{y}$$

and the residual sum of squares for the reduced model is

$$SS_{\text{Res}}(RM) = \mathbf{y}'\mathbf{y} - \hat{\boldsymbol{\gamma}}'\mathbf{Z}'\mathbf{y} \quad (n - p + r \text{ degrees of freedom})$$

The reduced model contains fewer parameters than the full model, so consequently $SS_{\text{Res}}(RM) \geq SS_{\text{Res}}(FM)$. To test the hypothesis $H_0: \mathbf{T}\boldsymbol{\beta} = \mathbf{0}$, we use the difference in residual sums of squares

$$SS_H = SS_{\text{Res}}(RM) - SS_{\text{Res}}(FM) \tag{3.39}$$

with $n - p + r - (n - p) = r$ degrees of freedom. Here SS_H is called the sum of squares due to the **hypothesis** $H_0: \mathbf{T}\boldsymbol{\beta} = \mathbf{0}$. The test statistic for this hypothesis is

$$F_0 = \frac{SS_H/r}{SS_{\text{Res}}(FM)/(n - p)} \tag{3.40}$$

We reject $H_0: \mathbf{T}\boldsymbol{\beta} = \mathbf{0}$ if $F_0 > F_{\alpha, r, n-p}$.

Example 3.6 Testing Equality of Regression Coefficients

The general linear hypothesis approach can be used to test the equality of regression coefficients. Consider the model

$$y = \beta_0 + \beta_1 x_1 + \beta_2 x_2 + \beta_3 x_3 + \varepsilon$$

For the full model, $SS_{\text{Res}}(RM)$ has $n - p = n - 4$ degrees of freedom. We wish to test $H_0: \beta_1 = \beta_3$. This hypothesis may be stated as $H_0: \mathbf{T}\boldsymbol{\beta} = \mathbf{0}$, where

$$\mathbf{T} = [0, 1, 0, -1]$$

is a 1×4 row vector. There is only one equation in $\mathbf{T}\boldsymbol{\beta} = \mathbf{0}$, namely, $\beta_1 - \beta_3 = 0$. Substituting this equation into the full model gives the reduced model

$$\begin{aligned} y &= \beta_0 + \beta_1 x_1 + \beta_2 x_2 + \beta_1 x_3 + \varepsilon \\ &= \beta_0 + \beta_1 (x_1 + x_3) + \beta_2 x_2 + \varepsilon \\ &= \gamma_0 + \gamma_1 z_1 + \gamma_2 z_2 + \varepsilon \end{aligned}$$

where $\gamma_0 = \beta_0$, $\gamma_1 = \beta_1 (= \beta_3)$, $z_1 = x_1 + x_3$, $\gamma_2 = \beta_2$, and $z_2 = x_2$. We would find $SS_{\text{Res}}(RM)$ with $n - 4 + 1 = n - 3$ degrees of freedom by fitting the reduced model. The sum of squares due to hypothesis $SS_{\text{H}} = SS_{\text{Res}}(RM) - SS_{\text{Res}}(FM)$ has $n - 3 - (n - 4) = 1$ degree of freedom. The F ratio (3.40) is $F_0 = (SS_{\text{H}}/1)[SS_{\text{Res}}(RM)/(n - 4)]$. Note that this hypothesis could also be tested by using the t statistic

$$t_0 = \frac{\hat{\beta}_1 - \hat{\beta}_3}{\text{se}(\hat{\beta}_1 - \hat{\beta}_3)} = \frac{\hat{\beta}_1 - \hat{\beta}_3}{\sqrt{\hat{\sigma}^2 (C_{11} + C_{33} - 2C_{13})}}$$

with $n - 4$ degrees of freedom. This is equivalent to the F test. ■

Example 3.7

Suppose that the model is

$$y = \beta_0 + \beta_1 x_1 + \beta_2 x_2 + \beta_3 x_3 + \varepsilon$$

and we wish to test $H_0: \beta_1 = \beta_3, \beta_2 = 0$. To state this in the form of the general linear hypothesis, let

$$\mathbf{T} = \begin{bmatrix} 0 & 1 & 0 & -1 \\ 0 & 0 & 1 & 0 \end{bmatrix}$$

There are now two equations in $\mathbf{T}\boldsymbol{\beta} = \mathbf{0}$, $\beta_1 - \beta_3 = 0$ and $\beta_2 = 0$. These equations give the reduced model

$$\begin{aligned} y &= \beta_0 + \beta_1 x_1 + \beta_1 x_3 + \varepsilon \\ &= \beta_0 + \beta_1 (x_1 + x_3) + \varepsilon \\ &= \gamma_0 + \gamma_1 z_1 + \varepsilon \end{aligned}$$

In this example, $SS_{\text{Res}}(RM)$ has $n - 2$ degrees of freedom, so SS_{R} has $n - 2 - (n - 4) = 2$ degrees of freedom. The F ratio (3.40) is $F_0 = (SS_{\text{H}}/2)/[SS_{\text{Res}}(FM)/(n - 4)]$. ■

The test statistic (3.40) for the general linear hypothesis may be written in another form, namely,

$$F_0 = \frac{\hat{\boldsymbol{\beta}}' \mathbf{T}' [\mathbf{T}(\mathbf{X}'\mathbf{X})^{-1} \mathbf{T}']^{-1} \mathbf{T} \hat{\boldsymbol{\beta}} / r}{SS_{\text{Res}}(FM)/(n - p)} \tag{3.41}$$

This form of the statistic could have been used to develop the test procedures illustrated in Examples 3.6 and 3.7.

There is a slight extension of the general linear hypothesis that is occasionally useful. This is

$$H_0: \mathbf{T}\boldsymbol{\beta} = \mathbf{c}, \quad H_1: \mathbf{T}\boldsymbol{\beta} \neq \mathbf{c} \tag{3.42}$$

for which the test statistic is

$$F_0 = \frac{(\mathbf{T}\hat{\boldsymbol{\beta}} - \mathbf{c})' [\mathbf{T}(\mathbf{X}'\mathbf{X})^{-1} \mathbf{T}']^{-1} (\mathbf{T}\hat{\boldsymbol{\beta}} - \mathbf{c}) / r}{SS_{\text{Res}}(FM)/(n - p)} \tag{3.43}$$

Since under the null hypothesis $\mathbf{T}\boldsymbol{\beta} = \mathbf{c}$, the distribution of F_0 in Eq. (3.43) is $F_{r, n-p}$, we would reject $H_0: \mathbf{T}\boldsymbol{\beta} = \mathbf{c}$ if $F_0 > F_{\alpha, r, n-p}$. That is, the test procedure is an upper one-tailed F test. Notice that the numerator of Eq. (3.43) expresses a measure of squared distance between $\mathbf{T}\boldsymbol{\beta}$ and \mathbf{c} standardized by the covariance matrix of $\mathbf{T}\boldsymbol{\beta}$.

To illustrate how this extended procedure can be used, consider the situation described in Example 3.6, and suppose that we wish to test

$$H_0: \beta_1 - \beta_3 = 2$$

Clearly $\mathbf{T} = [0, 1, 0, -1]$ and $\mathbf{c} = [2]$. For other uses of this procedure, refer to Problems 3.21 and 3.22.

Finally, if the hypothesis $H_0: \mathbf{T}\boldsymbol{\beta} = \mathbf{0}$ (or $H_0: \mathbf{T}\boldsymbol{\beta} = \mathbf{c}$) cannot be rejected, then it may be reasonable to estimate $\boldsymbol{\beta}$ subject to the constraint imposed by the null hypothesis. It is unlikely that the usual least-squares estimator will automatically satisfy the constraint. In such cases a **constrained least-squares estimator** may be useful. Refer to Problem 3.34.

3.4 CONFIDENCE INTERVALS IN MULTIPLE REGRESSION

Confidence intervals on individual regression coefficients and confidence intervals on the mean response given specific levels of the regressors play the same important role in multiple regression that they do in simple linear regression. This section develops the one-at-a-time confidence intervals for these cases. We also briefly introduce simultaneous confidence intervals on the regression coefficients.

3.4.1 Confidence Intervals on the Regression Coefficients

To construct **confidence interval estimates** for the regression coefficients β_j , we will continue to assume that the errors ε_i are normally and independently distributed with mean zero and variance σ^2 . Therefore, the observations y_i are normally and independently distributed with mean $\beta_0 + \sum_{j=1}^k \beta_j x_{ij}$ and variance σ^2 . Since the least-squares estimator $\hat{\boldsymbol{\beta}}$ is a linear combination of the observations, it follows that $\hat{\boldsymbol{\beta}}$ is normally distributed with mean vector $\boldsymbol{\beta}$ and covariance matrix $\sigma^2(\mathbf{X}'\mathbf{X})^{-1}$. This implies that the marginal distribution of any regression coefficient $\hat{\beta}_j$ is normal with mean β_j and variance $\sigma^2 C_{jj}$, where C_{jj} is the j th diagonal element of the $(\mathbf{X}'\mathbf{X})^{-1}$ matrix. Consequently, each of the statistics

$$\frac{\hat{\beta}_j - \beta_j}{\sqrt{\hat{\sigma}^2 C_{jj}}}, \quad j = 0, 1, \dots, k \quad (3.44)$$

is distributed as t with $n - p$ degrees of freedom, where $\hat{\sigma}^2$ is the estimate of the error variance obtained from Eq. (3.18).

Based on the result given in Eq. (3.44), we may define a **100(1 - α) percent confidence interval for the regression coefficient β_j** , $j = 0, 1, \dots, k$, as

$$\hat{\beta}_j - t_{\alpha/2, n-p} \sqrt{\hat{\sigma}^2 C_{jj}} \leq \beta_j \leq \hat{\beta}_j + t_{\alpha/2, n-p} \sqrt{\hat{\sigma}^2 C_{jj}} \quad (3.45)$$

Remember that we call the quantity

$$\text{se}(\hat{\beta}_j) = \sqrt{\hat{\sigma}^2 C_{jj}} \quad (3.46)$$

the standard error of the regression coefficient $\hat{\beta}_j$.

Example 3.8 The Delivery Time Data

We now find a 95% CI for the parameter β_1 in Example 3.1. The point estimate of β_1 is $\hat{\beta}_1 = 1.61591$, the diagonal element of $(\mathbf{X}'\mathbf{X})^{-1}$ corresponding to β_1 is $C_{11} = 0.00274378$, and $\hat{\sigma}^2 = 10.6239$ (from Example 3.2). Using Eq. (3.45), we find that

$$\begin{aligned} \hat{\beta}_1 - t_{0.025, 22} \sqrt{\hat{\sigma}^2 C_{11}} &\leq \beta_1 \leq \hat{\beta}_1 + t_{0.025, 22} \sqrt{\hat{\sigma}^2 C_{11}} \\ 1.61591 - (2.074) \sqrt{(10.6239)(0.00274378)} & \\ \leq \beta_1 &\leq 1.61591 + (2.074) \sqrt{(10.6239)(0.00274378)} \\ 1.61591 - (2.074)(0.17073) &\leq \beta_1 \leq 1.61591 + (2.074)(0.17073) \end{aligned}$$

and the 95% CI on β_1 is

$$1.26181 \leq \beta_1 \leq 1.97001$$

Notice that the Minitab output in Table 3.4 gives the standard error of each regression coefficient. This makes the construction of these intervals very easy in practice. ■

3.4.2 CI Estimation of the Mean Response

We may construct a CI on the mean response at a particular point, such as x_{01} , x_{02}, \dots, x_{0k} . Define the vector \mathbf{x}_0 as

$$\mathbf{x}_0 = \begin{bmatrix} 1 \\ x_{01} \\ x_{02} \\ \vdots \\ x_{0k} \end{bmatrix}$$

The fitted value at this point is

$$\hat{y}_0 = \mathbf{x}'_0 \hat{\boldsymbol{\beta}} \tag{3.47}$$

This is an unbiased estimator of $E(y|\mathbf{x}_0)$, since $E(\hat{y}_0) = \mathbf{x}'_0 \boldsymbol{\beta} = E(y|\mathbf{x}_0)$, and the variance of \hat{y}_0 is

$$\text{Var}(\hat{y}_0) = \sigma^2 \mathbf{x}'_0 (\mathbf{X}'\mathbf{X})^{-1} \mathbf{x}_0 \tag{3.48}$$

Therefore, a **100(1 - α) percent confidence interval on the mean response** at the point $x_{01}, x_{02}, \dots, x_{0k}$ is

$$\hat{y}_0 - t_{\alpha/2, n-p} \sqrt{\hat{\sigma}^2 \mathbf{x}'_0 (\mathbf{X}'\mathbf{X})^{-1} \mathbf{x}_0} \leq E(y|x_0) \leq \hat{y}_0 + t_{\alpha/2, n-p} \sqrt{\hat{\sigma}^2 \mathbf{x}'_0 (\mathbf{X}'\mathbf{X})^{-1} \mathbf{x}_0} \tag{3.49}$$

This is the multiple regression generalization of Eq. (2.43).

Example 3.9 The Delivery Time Data

The soft drink bottler in Example 3.1 would like to construct a 95% CI on the mean delivery time for an outlet requiring $x_1 = 8$ cases and where the distance $x_2 = 275$ feet. Therefore,

$$\mathbf{x}_0 = \begin{bmatrix} 1 \\ 8 \\ 275 \end{bmatrix}$$

The fitted value at this point is found from Eq. (3.47) as

$$\hat{y}_0 = \mathbf{x}'_0 \hat{\boldsymbol{\beta}} = [1 \quad 8 \quad 275] \begin{bmatrix} 2.34123 \\ 1.61591 \\ 0.01438 \end{bmatrix} = 19.22 \text{ minutes}$$

The variance of \hat{y}_0 is estimated by

$$\begin{aligned} \hat{\sigma}^2 \mathbf{x}'_0 (\mathbf{X}'\mathbf{X})^{-1} \mathbf{x}_0 &= 10.6239 [1 \quad 8 \quad 275] \\ &\times \begin{bmatrix} 0.11321518 & -0.00444859 & -0.00008367 \\ -0.00444859 & 0.00274378 & -0.00004786 \\ -0.00008367 & -0.00004786 & 0.00000123 \end{bmatrix} \begin{bmatrix} 1 \\ 8 \\ 275 \end{bmatrix} \\ &= 10.6239(0.05346) = 0.56794 \end{aligned}$$

Therefore, a 95% CI on the mean delivery time at this point is found from Eq. (3.49) as

$$19.22 - 2.074\sqrt{0.56794} \leq E(y|x_0) \leq 19.22 + 2.074\sqrt{0.56794}$$

which reduces to

$$17.66 \leq E(y|x_0) \leq 20.78$$

Ninety-five percent of such intervals will contain the true delivery time. ■

The length of the CI on the mean response is a useful measure of the quality of the regression model. It can also be used to compare competing models. To illustrate, consider the 95% CI on the mean delivery time when $x_1 = 8$ cases and $x_2 = 275$ feet. In Example 3.9 this CI is found to be (17.66, 20.78), and the length of this interval is $20.78 - 17.66 = 3.12$ minutes. If we consider the simple linear regression model with $x_1 =$ cases as the only regressor, the 95% CI on the mean delivery time with $x_1 = 8$ cases is (18.99, 22.97). The length of this interval is $22.47 - 18.99 = 3.45$ minutes. Clearly, adding cases to the model has improved the precision of estimation. However, the change in the length of the interval depends on the location of the point in the x space. Consider the point $x_1 = 16$ cases and $x_2 = 688$ feet. The 95% CI for the multiple regression model is (36.11, 40.08) with length 3.97 minutes, and for the simple linear regression model the 95% CI at $x_1 = 16$ cases is (35.60, 40.68) with length 5.08 minutes. The improvement from the multiple regression model is even better at this point. Generally, the further the point is from the centroid of the x space, the greater the difference will be in the lengths of the two CIs.

3.4.3 Simultaneous Confidence Intervals on Regression Coefficients

We have discussed procedures for constructing several types of confidence and prediction intervals for the linear regression model. We have noted that these are one-at-a-time intervals, that is, they are the usual type of confidence or prediction interval where the confidence coefficient $1 - \alpha$ indicates the proportion of correct statements that results when repeated random samples are selected and the appropriate interval estimate is constructed for each sample. Some problems require that several confidence or prediction intervals be constructed using the same sample data. In these cases, the analyst is usually interested in specifying a confidence coefficient that applies **simultaneously** to the entire **set** of interval estimates. A set of confidence or prediction intervals that are all true simultaneously with probability $1 - \alpha$ are called **simultaneous** or **joint confidence** or joint prediction intervals.

As an example, consider a simple linear regression model. Suppose that the analyst wants to draw inferences about the intercept β_0 and the slope β_1 . One possibility would be to construct 95% (say) CIs about both parameters. However, if these interval estimates are independent, the probability that both statements are correct is $(0.95)^2 = 0.9025$. Thus, we do not have a confidence level of 95% associated with both statements. Furthermore, since the intervals are constructed using the same set of sample data, they are not independent. This introduces a further complication into determining the confidence level for the set of statements.

It is relatively easy to define a **joint confidence region** for the multiple regression model parameters β . We may show that

$$\frac{(\hat{\beta} - \beta)' \mathbf{X}'\mathbf{X}(\hat{\beta} - \beta)}{pMS_{\text{Res}}} \sim F_{p,n-p}$$

and this implies that

$$P \left\{ \frac{(\hat{\beta} - \beta)' \mathbf{X}'\mathbf{X}(\hat{\beta} - \beta)}{pMS_{\text{Res}}} \leq F_{\alpha,n-p} \right\} = 1 - \alpha$$

Consequently, a $100(1 - \alpha)$ percent **joint confidence region** for all of the parameters in β is

$$\frac{(\hat{\beta} - \beta)' \mathbf{X}'\mathbf{X}(\hat{\beta} - \beta)}{pMS_{\text{Res}}} \leq F_{\alpha,p,n-p} \tag{3.50}$$

This inequality describes an elliptically shaped region. Construction of this joint confidence region is relatively straightforward for simple linear regression ($p = 2$). It is more difficult for $p = 3$ and would require special three-dimensional graphics software.

Example 3.10 The Rocket Propellant Data

For the case of simple linear regression, we can show that Eq. (3.50) reduces to

$$\frac{n(\hat{\beta}_0 - \beta_0)^2 + 2 \sum_{i=1}^n x_i (\hat{\beta}_0 - \beta_0)(\hat{\beta}_1 - \beta_1) + \sum_{i=1}^n x_i^2 (\hat{\beta}_1 - \beta_1)^2}{2MS_{\text{Res}}} \leq F_{\alpha,2,n-2}$$

To illustrate the construction of this confidence region, consider the rocket propellant data in Example 2.1. We will find a 95% confidence region for β_0 and β_1 . $\hat{\beta}_0 = 2627.82$, $\hat{\beta}_1 = -37.15$, $\sum_{i=1}^{20} x_i^2 = 4677.69$, $MS_{\text{Res}} = 9244.59$, and $F_{0.05,2,18} = 3.55$, we may substitute into the above equation, yielding

$$\left[20(2627.82 - \beta_0)^2 + 2(267.25)(2627.82 - \beta_0)(-37.15 - \beta_1) + (4677.69)(-37.15 - \beta_1)^2 \right] / [2(9244.59)] = 3.55$$

as the boundary of the ellipse.

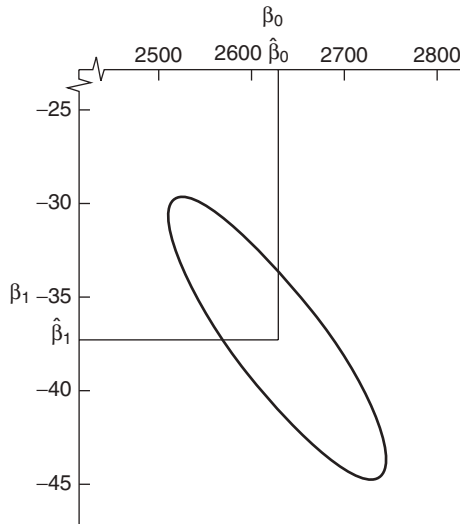

Figure 3.8 Joint 95% confidence region for β_0 and β_1 for the rocket propellant data.

The joint confidence region is shown in Figure 3.8. Note that this ellipse is not parallel to the β_1 axis. The tilt of the ellipse is a function of the covariance between $\hat{\beta}_0$ and $\hat{\beta}_1$, which is $-\bar{x}\sigma^2/S_{xx}$. A positive covariance implies that errors in the point estimates of β_0 and β_1 are likely to be in the same direction, while a negative covariance indicates that these errors are likely to be in opposite directions. In our example \bar{x} is positive so $\text{Cov}(\hat{\beta}_0, \hat{\beta}_1)$ is negative. Thus, if the estimate of the slope is too steep (β_1 is overestimated), the estimate of the intercept is likely to be too small (β_0 is underestimated). The elongation of the region depends on the relative sizes of the variances of β_0 and β_1 . Generally, if the ellipse is elongated in the β_0 direction (for example), this implies that β_0 is not estimated as precisely as β_1 . This is the case in our example. ■

There is another general approach for obtaining simultaneous interval estimates of the parameters in a linear regression model. These CIs may be constructed by using

$$\hat{\beta}_j \pm \Delta \text{se}(\hat{\beta}_j), \quad j = 0, 1, \dots, k \tag{3.51}$$

where the constant Δ is chosen so that a specified probability that all intervals are correct is obtained.

Several methods may be used to choose Δ in (3.51). One procedure is the **Bonferroni method**. In this approach, we set $\Delta = t_{\alpha/2p, n-p}$ so that (3.51) becomes

$$\hat{\beta}_j \pm t_{\alpha/2p, n-p} \text{se}(\hat{\beta}_j), \quad j = 0, 1, \dots, k \tag{3.52}$$

The probability is at least $1 - \alpha$ that all intervals are correct. Notice that the **Bonferroni confidence intervals** look somewhat like the ordinary one-at-a-time CIs based on the t distribution, except that each Bonferroni interval has a confidence coefficient $1 - \alpha/p$ instead of $1 - \alpha$.

Example 3.11 The Rocket Propellant Data

We may find 90% joint CIs for β_0 and β_1 for the rocket propellant data in Example 2.1 by constructing a 95% CI for each parameter. Since

$$\begin{aligned}\hat{\beta}_0 &= 2627.822, & \text{se}(\hat{\beta}_0) &= 44.184 \\ \hat{\beta}_1 &= -37.154, & \text{se}(\hat{\beta}_1) &= 2.889\end{aligned}$$

and $t_{0.05/2,18} = t_{0.025,18} = 2.101$, the joint CIs are

$$\begin{aligned}\hat{\beta}_0 - t_{0.0125,18}\text{se}(\hat{\beta}_0) &\leq \beta_0 \leq \hat{\beta}_0 + t_{0.0125,18}\text{se}(\hat{\beta}_0) \\ 2627.822 - (2.445)(44.184) &\leq \beta_0 \leq 2627.822 + (2.445)(44.184) \\ 2519.792 &\leq \beta_0 \leq 2735.852\end{aligned}$$

and

$$\begin{aligned}\hat{\beta}_1 - t_{0.0125,18}\text{se}(\hat{\beta}_1) &\leq \beta_1 \leq \hat{\beta}_1 + t_{0.0125,18}\text{se}(\hat{\beta}_1) \\ -37.154 - (2.445)(2.889) &\leq \beta_1 \leq -37.154 + (2.445)(2.889) \\ -44.218 &\leq \beta_1 \leq -30.090\end{aligned}$$

We conclude with 90% confidence that this procedure leads to correct interval estimates for both parameters. ■

The confidence ellipse is always a more efficient procedure than the Bonferroni method because the volume of the ellipse is always less than the volume of the space covered by the Bonferroni intervals. However, the Bonferroni intervals are easier to construct.

Constructing Bonferroni CIs often requires significance levels not listed in the usual t tables. Many modern calculators and software packages have values of $t_{\alpha,\nu}$ on call as a library function.

The Bonferroni method is not the only approach to choosing Δ in (3.51). Other approaches include the **Scheffé S-method** (see Scheffé [1953, 1959]), for which

$$\Delta = (2F_{\alpha,p,n-p})^{1/2}$$

and the **maximum modulus t procedure** (see Hahn [1972] and Hahn and Hendrickson [1971]), for which

$$\Delta = u_{\alpha,p,n-p}$$

where $u_{\alpha,p,n-p}$ is the upper α -tail point of the distribution of the maximum absolute value of two independent student t random variables each based on $n - 2$ degrees of freedom. An obvious way to compare these three techniques is in terms of the lengths of the CIs they generate. Generally the Bonferroni intervals are shorter than the Scheffé intervals and the maximum modulus t intervals are shorter than the Bonferroni intervals.

3.5 PREDICTION OF NEW OBSERVATIONS

The regression model can be used to predict future observations on y corresponding to particular values of the regressor variables, for example, $x_{01}, x_{02}, \dots, x_{0k}$. If $\mathbf{x}'_0 = [1, x_{01}, x_{02}, \dots, x_{0k}]$, then a **point estimate of the future observation** y_0 at the point $x_{01}, x_{02}, \dots, x_{0k}$ is

$$\hat{y}_0 = \mathbf{x}'_0 \hat{\boldsymbol{\beta}} \quad (3.53)$$

A **100(1 - α) percent prediction interval** for this future observation is

$$\hat{y}_0 - t_{\alpha/2, n-p} \sqrt{\hat{\sigma}^2 (1 + \mathbf{x}'_0 (\mathbf{X}'\mathbf{X})^{-1} \mathbf{x}_0)} \leq y_0 \leq \hat{y}_0 + t_{\alpha/2, n-p} \sqrt{\hat{\sigma}^2 (1 + \mathbf{x}'_0 (\mathbf{X}'\mathbf{X})^{-1} \mathbf{x}_0)} \quad (3.54)$$

This is a generalization of the prediction interval for a future observation in simple linear regression, (2.45).

Example 3.12 The Delivery Time Data

Suppose that the soft drink bottler in Example 3.1 wishes to construct a 95% prediction interval on the delivery time at an outlet where $x_1 = 8$ cases are delivered and the distance walked by the deliveryman is $x_2 = 275$ feet. Note that $\mathbf{x}'_0 = [1, 8, 275]$, and the point estimate of the delivery time is $\hat{y}_0 = \mathbf{x}'_0 \boldsymbol{\beta} = 19.22$ minutes. Also, in Example 3.9 we calculated $\mathbf{x}'_0 (\mathbf{X}'\mathbf{X})^{-1} \mathbf{x}_0 = 0.05346$. Therefore, from (3.54) we have

$$19.22 - 2.074 \sqrt{10.6239(1 + 0.05346)} \leq y_0 \leq 19.22 + 2.074 \sqrt{10.6239(1 + 0.05346)}$$

and the 95% prediction interval is

$$12.28 \leq y_0 \leq 26.16 \quad \blacksquare$$

3.6 A MULTIPLE REGRESSION MODEL FOR THE PATIENT SATISFACTION DATA

In Section 2.7 we introduced the hospital patient satisfaction data and built a simple linear regression model relating patient satisfaction to a severity measure of the patient's illness. The data used in this example is in Table B17. In the simple linear regression model the regressor severity was significant, but the model fit to the data wasn't entirely satisfactory. Specifically, the value of R^2 was relatively low, approximately 0.43. We noted that there could be several reasons for a low value of R^2 , including missing regressors. Figure 3.9 is the JMP output that results when we fit a multiple linear regression model to the satisfaction response using severity and patient age as the predictor variables.

In the multiple linear regression model we notice that the plot of actual versus predicted response is much improved when compared to the plot for the simple linear regression model (compare Figure 3.9 to Figure 2.7). Furthermore, the model is significant and both variables, age and severity, contribute significantly to the model. The R^2 has increased from 0.43 to 0.81. The mean square error in the multiple

Response Satisfaction

Whole Model

Actual by Predicted Plot

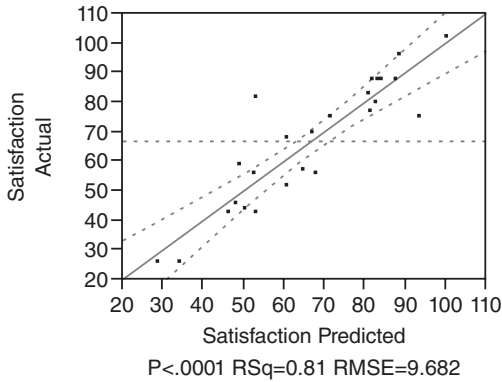

Summary of Fit

RSquare	0.809595
RSquare Adj	0.792285
Root Mean Square Error	9.681956
Mean of Response	66.72
Observations (or Sum Wgts)	25

Analysis of Variance

Source	DF	Sum of Squares	Mean Square	F Ratio
Model	2	8768.754	4384.38	46.7715
Error	22	2062.286	93.74	Prob > F
C. Total	24	10831.040		<.0001*

Parameter Estimates

Term	Estimate	Std Error	t Ratio	Prob> t
Intercept	139.92335	8.100194	17.27	<.0001*
Age	-1.046154	0.157263	-6.65	<.0001*
Severity	-0.435907	0.178754	-2.44	0.0233*

Figure 3.9 JMP output for the multiple linear regression model for the patient satisfaction data.

linear regression model is 90.74, considerably smaller than the mean square error in the simple linear regression model, which was 270.02. The large reduction in mean square error indicates that the two-variable model is much more effective in explaining the variability in the data than the original simple linear regression model. This reduction in the mean square error is a quantitative measure of the improvement we qualitatively observed in the plot of actual response versus the predicted response when the predictor age was added to the model. Finally, the response is predicted with better precision in the multiple linear model. For example, the standard deviation of the predicted response for a patient that is 42 year old with a severity index

of 30 is 3.10 for the multiple linear regression model while it is 5.25 for the simple linear regression model that includes only severity as the predictor. Consequently the prediction interval would be considerably wider for the simple linear regression model. Adding an important predictor to a regression model (age in this example) can often result in a much better fitting model with a smaller standard error and as a consequence narrow confidence intervals on the mean response and narrower prediction intervals.

3.7 USING SAS AND R FOR BASIC MULTIPLE LINEAR REGRESSION

SAS is an important statistical software package. Table 3.7 gives the source code to analyze the delivery time data that we have been analyzing throughout this chapter. The statement PROC REG tells the software that we wish to perform an ordinary least-squares linear regression analysis. The “model” statement gives the specific model and tells the software which analyses to perform. The commands for the

TABLE 3.7 SAS Code for Delivery Time Data

```

date delivery;
input time cases distance;
cards;
16.68 7 560
11.50 3 220
12.03 3 340
14.88 4 80
13.75 6 150
18.11 7 330
8.00 2 110
17.83 7 210
79.24 30 1460
21.50 5 605
40.33 16 688
21.00 10 215
13.50 4 255
19.75 6 462
24.00 9 448
29.00 10 776
15.35 6 200
19.00 7 132
9.50 3 36
35.10 17 770
17.90 10 140
52.32 26 810
18.75 9 450
19.83 8 635
10.75 4 150
proc reg;
model time = cases distance/p clm cli;
run;

```

optional analyses appear after the solidus. PROC REG always produces the analysis-of-variance table and the information on the parameter estimates. The “p clm cli” options on the model statement produced the information on the predicted values. Specifically, “p” asks SAS to print the predicted values, “clm” (which stands for confidence limit, mean) asks SAS to print the confidence band, and “cli” (which stands for confidence limit, individual observations) asks to print the prediction band. Table 3.8 gives the resulting output, which is consistent with the Minitab analysis.

We next illustrate the R code required to do the same analysis. The first step is to create the data set. The easiest way is to input the data into a text file using spaces for delimiters. Each row of the data file is a record. The top row should give the names for each variable. All other rows are the actual data records. Let `delivery.txt` be the name of the data file. The first row of the text file gives the variable names:

```
time cases distance
```

The next row is the first data record, with spaces delimiting each data item:

```
16.68 7 560
```

The R code to read the data into the package is:

```
deliver <- read.table("delivery.txt",header=TRUE, sep=" ")
```

The object `deliver` is the R data set, and “`delivery.txt`” is the original data file. The phrase, `header=TRUE` tells R that the first row is the variable names. The phrase `sep=" "` tells R that the data are space delimited.

The commands

```
deliver.model <- lm(time~cases+distance, data=deliver)
summary(deliver.model)
```

tell R

- to estimate the model, and
- to print the analysis of variance, the estimated coefficients, and their tests.

3.8 HIDDEN EXTRAPOLATION IN MULTIPLE REGRESSION

In predicting new responses and in estimating the mean response at a given point $x_{01}, x_{02}, \dots, x_{0k}$ one must be careful about **extrapolating** beyond the region containing the original observations. It is very possible that a model that fits well in the region of the original data will perform poorly outside that region. In multiple regression it is easy to inadvertently extrapolate, since the levels of the regressors

TABLE 3.8 SAS Output for the Analysis of Delivery Time Data

SAS System 1						
The REG Procedure						
Model: MODEL1						
Dependent Variable: time						
Number of Observation Read 25						
Number of Observations Used 25						
Analysis of Variance						
Source	DF	Sun of Squares	Mean Square	F Value	Pr > F	
Model	2	5550.81092	2775.40546	261.24	<.0001	
Error	22	233.73168	10.62417			
Corrected Total	24	5784.54260				
Root MSE	3.25947		R- Square	0.9596		
Dependent Mean	22.38400		Adj R- Sq	0.9559		
Coeff Var	14.56162					
Parameter Estimates						
Variable	DF	Parameter Estimate	Standard Error	t value	Pr > t	
Intercept	1	2.34123	1.09673	2.13	0.0442	
Cases	1	1.61591	0.17073	9.46	<.0001	
Distance	1	0.01438	0.00361	3.98	0.0006	
The SAS System 2						
The REG Procedure						
Model: MODEL1						

Dependent Variable: time

Output Statistics

Obs	Dependent Variable		Predicted		Std error		Mean		95% CL		Predict		Residual	
	Variable	Value	Value	Mean	Mean	Predict	95% CL	Mean	95% CL	Predict	95% CL	Predict	Residual	
1	16.6800	21.7081	1.0400	19.5513	23.8649	14.6126	28.8036	-5.0281						
2	11.5000	10.3536	0.8667	8.5562	12.1510	3.3590	17.3482	1.1464						
3	12.0300	12.0798	1.0242	9.9557	14.2038	4.9942	19.1654	-0.0498						
4	14.8800	9.9556	0.9524	7.9805	11.9308	2.9133	16.9980	4.9244						
5	13.7500	14.1944	0.8927	12.3430	16.0458	7.1857	21.2031	-0.4444						
6	18.1100	18.3996	0.6749	17.0000	19.7991	11.4965	25.3027	-0.2896						
7	8.0000	7.1554	0.9322	5.2221	9.0887	0.1246	14.1861	0.8446						
8	17.8300	16.6734	0.8228	14.9670	18.3798	9.7016	23.6452	1.1566						
9	79.2400	71.8203	2.3009	67.0486	76.5920	63.5461	80.0945	7.4197						
10	21.5000	19.1236	1.4441	16.1287	22.1185	11.7301	26.5171	2.3764						
11	40.3300	38.0925	0.9566	36.1086	40.0764	31.0477	45.1373	2.2378						
12	21.0000	21.5930	1.0989	19.3141	23.8719	14.4595	28.7266	-0.5930						
13	13.5000	12.4730	0.8059	10.8018	14.1442	5.5097	19.4363	1.0270						
14	19.7500	18.6825	0.9117	16.7916	20.5733	11.6633	25.7017	1.0675						
15	24.0000	23.3288	0.6609	21.9582	24.6994	16.4315	30.2261	0.6712						
16	29.0000	29.6629	1.3278	26.9093	32.4166	22.3639	36.9620	-0.6629						
17	15.3500	14.9136	0.7946	13.2657	16.5616	7.9559	21.8713	0.4364						
18	19.0000	15.5514	1.0113	13.4541	17.6486	8.4738	22.6290	3.4486						
19	9.5000	7.7068	1.0123	5.6075	9.8061	0.6286	14.7850	1.7932						
20	35.1000	40.8880	1.0394	38.7324	43.0435	33.7929	47.9831	-5.7880						
21	17.9000	20.5142	1.3251	17.7661	23.2623	13.2172	27.8112	-2.6142						
22	52.3200	56.0065	2.0396	51.7766	60.2365	48.0324	63.9807	-3.6865						
23	18.7500	23.3576	0.6621	21.9845	24.7306	16.4598	30.2553	-4.6076						
24	19.8300	24.4029	1.1320	22.0553	26.7504	17.2471	31.5586	-4.5729						
25	10.7500	10.9626	0.8414	9.2175	12.7076	3.9812	17.9439	-0.2126						
		Sum of Residuals	0											
		Sum of Squared Residuals	233.73168											
		Predicted Residual SS (PRESS)	459.03931											

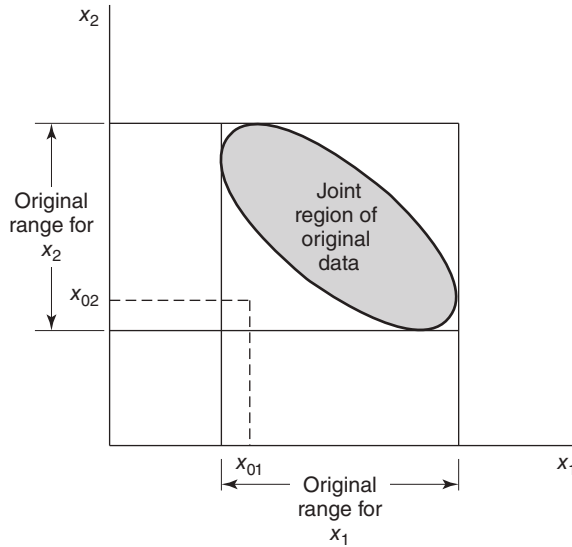

Figure 3.10 An example of extrapolation in multiple regression.

$(x_{i1}, x_{i2}, \dots, x_{ik}), i = 1, 2, \dots, n$, jointly define the region containing the data. As an example, consider Figure 3.10, which illustrates the region containing the original data for a two-regressor model. Note that the point (x_{01}, x_{02}) lies within the ranges of both regressors x_1 and x_2 but outside the region of the original data. Thus, either predicting the value of a new observation or estimating the mean response at this point is an extrapolation of the original regression model.

Since simply comparing the levels of the x 's for a new data point with the ranges of the original x 's will not always detect a hidden extrapolation, it would be helpful to have a formal procedure to do so. We will define the smallest convex set containing all of the original n data points $(x_{i1}, x_{i2}, \dots, x_{ik}), i = 1, 2, \dots, n$, as the regressor variable hull (RVH). If a point $x_{01}, x_{02}, \dots, x_{0k}$ lies inside or on the boundary of the RVH, then prediction or estimation involves interpolation, while if this point lies outside the RVH, extrapolation is required.

The diagonal elements h_{ii} of the hat matrix $\mathbf{H} = \mathbf{X}(\mathbf{X}'\mathbf{X})^{-1}\mathbf{X}'$ are useful in detecting **hidden extrapolation**. The values of h_{ii} depend both on the Euclidean distance of the point \mathbf{x}_i from the centroid and on the density of the points in the RVH. In general, the point that has the largest value of h_{ii} , say h_{\max} , will lie on the boundary of the RVH in a region of the x space where the density of the observations is relatively low. The set of points \mathbf{x} (not necessarily data points used to fit the model) that satisfy

$$\mathbf{x}'(\mathbf{X}'\mathbf{X})^{-1}\mathbf{x} \leq h_{\max}$$

is an ellipsoid enclosing all points inside the RVH (see Cook [1979] and Weisberg [1985]). Thus, if we are interested in prediction or estimation at the point $\mathbf{x}'_0 = [1, x_{01}, x_{02}, \dots, x_{0k}]$, the location of that point relative to the RVH is reflected by

$$h_{00} = \mathbf{x}'_0(\mathbf{X}'\mathbf{X})^{-1}\mathbf{x}_0$$

Points for which $h_{00} > h_{\max}$ are outside the ellipsoid enclosing the RVH and are extrapolation points. However, if $h_{00} < h_{\max}$, then the point is inside the ellipsoid and possibly inside the RVH and would be considered an interpolation point because it is close to the cloud of points used to fit the model. Generally the smaller the value of h_{00} , the closer the point \mathbf{x}_0 lies to the centroid of the x space.[†]

Weisberg [1985] notes that this procedure does not produce the smallest volume ellipsoid containing the RVH. This is called the minimum covering ellipsoid (MCE). He gives an iterative algorithm for generating the MCE. However, the test for extrapolation based on the MCE is still only an approximation, as there may still be regions inside the MCE where there are no sample points.

Example 3.13 Hidden Extrapolation—The Delivery Time Data

We illustrate detecting hidden extrapolation using the soft drink delivery time data in Example 3.1. The values of h_{ii} for the 25 data points are shown in Table 3.9. Note that observation 9, represented by \blacklozenge in Figure 3.11, has the largest value of h_{ii} . Figure 3.11 confirms that observation 9 is on the boundary of the RVH.

Now suppose that we wish to consider prediction or estimation at the following four points:

Point	Symbols in Figure 3.10	x_{10}	x_{20}	h_{00}
<i>a</i>	□	8	275	0.05346
<i>b</i>	△	20	250	0.58917
<i>c</i>	+	28	500	0.89874
<i>d</i>	×	8	1200	0.86736

All of these points lie within the ranges of the regressors x_1 and x_2 . In Figure 3.11 point *a* (used in Examples 3.9 and 3.12 for estimation and prediction), for which $h_{00} = 0.05346$, is an interpolation point since $h_{00} = 0.05346 < h_{\max} = 0.49829$. The remaining points *b*, *c*, and *d* are all extrapolation points, since their values of h_{00} exceed h_{\max} . This is readily confirmed by inspection of Figure 3.11. ■

3.9 STANDARDIZED REGRESSION COEFFICIENTS

It is usually difficult to directly compare regression coefficients because the magnitude of $\hat{\beta}_j$ reflects the units of measurement of the regressor x_j . For example, suppose that the regression model is

[†]If h_{\max} is much larger than the next largest value, the point is a severe outlier in x space. The presence of such an outlier may make the ellipse much larger than desirable. In these cases one could use the second largest value of h_{ii} as h_{\max} . This approach may be useful when the most remote point has been severely downweighted, say by the robust fitting techniques discussed in Chapter 15.

TABLE 3.9 Values of h_{ii} for the Delivery Time Data

Observation, i	Cases, x_{i1}	Distance, x_{i2}	h_{ii}
1	7	560	0.10180
2	3	220	0.07070
3	3	340	0.09874
4	4	80	0.08538
5	6	150	0.07501
6	7	330	0.04287
7	2	110	0.08180
8	7	210	0.06373
9	30	1460	$0.49829 = h_{\max}$
10	5	605	0.19630
11	16	688	0.08613
12	10	215	0.11366
13	4	255	0.06113
14	6	462	0.07824
15	9	448	0.04111
16	10	776	0.16594
17	6	200	0.05943
18	7	132	0.09626
19	3	36	0.09645
20	17	770	0.10169
21	10	140	0.16528
22	26	810	0.39158
23	9	450	0.04126
24	8	635	0.12061
25	4	150	0.06664

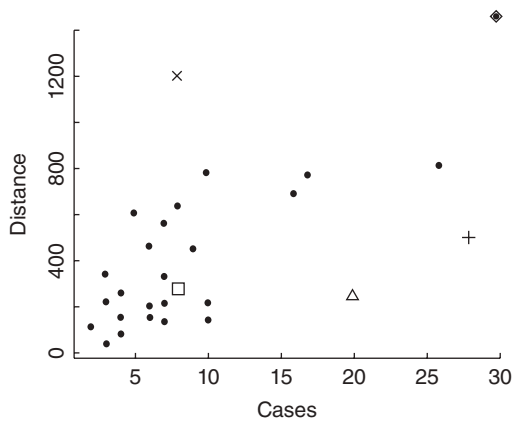

Figure 3.11 Scatterplot of cases and distance for the delivery time data.

$$\hat{y} = 5 + x_1 + 1000x_2$$

and y is measured in liters, x_1 is measured in milliliters, and x_2 is measured in liters. Note that although $\hat{\beta}_2$ is considerably larger than $\hat{\beta}_1$, the effect of both regressors on \hat{y} is identical, since a 1-liter change in either x_1 or x_2 when the other variable is held constant produces the same change in \hat{y} . Generally the units of the regression coefficient β_j are units of y /units of x_j . For this reason, it is sometimes helpful to work with scaled regressor and response variables that produce **dimensionless regression coefficients**. These dimensionless coefficients are usually called **standardized regression coefficients**. We now show how they are computed, using two popular scaling techniques.

Unit Normal Scaling The first approach employs **unit normal scaling** for the regressors and the response variable. That is,

$$z_{ij} = \frac{x_{ij} - \bar{x}_j}{s_j}, \quad i = 1, 2, \dots, n, \quad j = 1, 2, \dots, k \quad (3.55)$$

and

$$y_i^* = \frac{y_i - \bar{y}}{s_y}, \quad i = 1, 2, \dots, n \quad (3.56)$$

where

$$s_j^2 = \frac{\sum_{i=1}^n (x_{ij} - \bar{x}_j)^2}{n-1}$$

is the sample variance of regressor x_j and

$$s_y^2 = \frac{\sum_{i=1}^n (y_i - \bar{y})^2}{n-1}$$

is the sample variance of the response. Note the similarity to standardizing a normal random variable. All of the scaled regressors and the scaled responses have sample mean equal to zero and sample variance equal to 1.

Using these new variables, the regression model becomes

$$y_i^* = b_1 z_{i1} + b_2 z_{i2} + \dots + b_k z_{ik} + \varepsilon_i, \quad i = 1, 2, \dots, n \quad (3.57)$$

Centering the regressor and response variables by subtracting \bar{x}_j and \bar{y} removes the intercept from the model (actually the least-squares estimate of b_0 is $\hat{b} = \bar{y}^* = 0$). The least-squares estimator of \mathbf{b} is

$$\hat{\mathbf{b}} = (\mathbf{Z}'\mathbf{Z})^{-1} \mathbf{Z}'\mathbf{y}^* \quad (3.58)$$

Unit Length Scaling The second popular scaling is **unit length scaling**,

$$w_{ij} = \frac{x_{ij} - \bar{x}_j}{s_{jj}^{1/2}}, \quad i = 1, 2, \dots, n, \quad j = 1, 2, \dots, k \quad (3.59)$$

and

$$y_i^0 = \frac{y_i - \bar{y}}{SS_T^{1/2}}, \quad i = 1, 2, \dots, n \quad (3.60)$$

where

$$S_{jj} = \sum_{i=1}^n (x_{ij} - \bar{x}_j)^2$$

is the corrected sum of squares for regressor x_j . In this scaling, each new regressor w_j has mean $\bar{w}_j = 0$ and length $\sqrt{\sum_{i=1}^n (w_{ij} - \bar{w}_j)^2} = 1$. In terms of these variables, the regression model is

$$y_i^0 = b_1 w_{i1} + b_2 w_{i2} + \dots + b_k w_{ik} + \varepsilon_i, \quad i = 1, 2, \dots, n \quad (3.61)$$

The vector of least-squares regression coefficients is

$$\hat{\mathbf{b}} = (\mathbf{W}'\mathbf{W})^{-1} \mathbf{W}'\mathbf{y}^0 \quad (3.62)$$

In the unit length scaling, the $\mathbf{W}'\mathbf{W}$ matrix is in the form of a **correlation matrix**, that is,

$$\mathbf{W}'\mathbf{W} = \begin{bmatrix} 1 & r_{12} & r_{13} & \cdots & r_{1k} \\ r_{12} & 1 & r_{23} & \cdots & r_{2k} \\ r_{13} & r_{23} & 1 & \cdots & r_{3k} \\ \vdots & \vdots & \vdots & & \vdots \\ r_{1k} & r_{2k} & r_{3k} & \cdots & 1 \end{bmatrix}$$

where

$$r_{ij} = \frac{\sum_{u=1}^n (x_{ui} - \bar{x}_i)(x_{uj} - \bar{x}_j)}{(S_{ii}S_{jj})^{1/2}} = \frac{S_{ij}}{(S_{ii}S_{jj})^{1/2}}$$

is the simple correlation between regressors x_i and x_j . Similarly,

$$\mathbf{W}'\mathbf{y}^0 = \begin{bmatrix} r_{1y} \\ r_{2y} \\ r_{3y} \\ \vdots \\ r_{ky} \end{bmatrix}$$

where

$$r_{jy} = \frac{\sum_{u=1}^n (x_{uj} - \bar{x}_j)(y_u - \bar{y})}{(S_{jj}SS_T)^{1/2}} = \frac{S_{jy}}{(S_{jj}SS_T)^{1/2}}$$

is the simple correlation[†] between the regressor x_j and the response y . If unit normal scaling is used, the $\mathbf{Z}'\mathbf{Z}$ matrix is closely related to $\mathbf{W}'\mathbf{W}$; in fact,

$$\mathbf{Z}'\mathbf{Z} = (n-1)\mathbf{W}'\mathbf{W}$$

Consequently, the estimates of the regression coefficients in Eqs. (3.58) and (3.62) are identical. That is, it does not matter which scaling we use; they both produce the same set of dimensionless regression coefficients $\hat{\mathbf{b}}$.

The regression coefficients $\hat{\mathbf{b}}$ are usually called **standardized regression coefficients**. The relationship between the original and standardized regression coefficients is

$$\hat{\beta}_j = \hat{b}_j \left(\frac{SS_T}{S_{jj}} \right)^{1/2}, \quad j = 1, 2, \dots, k \quad (3.63)$$

and

$$\hat{\beta}_0 = \bar{y} - \sum_{j=1}^k \hat{\beta}_j \bar{x}_j \quad (3.64)$$

Many multiple regression computer programs use this scaling to reduce problems arising from round-off errors in the $(\mathbf{X}'\mathbf{X})^{-1}$ matrix. These round-off errors may be very serious if the original variables differ considerably in magnitude. Most computer programs also display both the original regression coefficients and the standardized regression coefficients, which are often referred to as “beta coefficients.” In interpreting standardized regression coefficients, we must remember that they are still **partial regression coefficients** (i.e., b_j measures the effect of x_j given that other regressors x_i , $i \neq j$, are in the model). Furthermore, the b_j are affected by the range of values for the regressor variables. Consequently, it may be dangerous to use the magnitude of the \hat{b}_j as a measure of the relative importance of regressor x_j .

Example 3.14 The Delivery Time Data

We find the standardized regression coefficients for the delivery time data in Example 3.1. Since

$$\begin{aligned} SS_T &= 5784.5426, & S_{11} &= 1136.5600 \\ S_{1y} &= 2473.3440, & S_{22} &= 2,537,935.0330 \end{aligned}$$

[†]It is customary to refer to r_{iy} and r_{ij} as correlations even though the regressors are not necessarily random variables.

$$S_{2y} = 108,038.6019, \quad S_{12} = 44,266.6800$$

we find (using the unit length scaling) that

$$r_{12} = \frac{S_{12}}{(S_{11}S_{22})^{1/2}} = \frac{44,266.6800}{\sqrt{(1136.5600)(2,537,935.0303)}} = 0.824215$$

$$r_{1y} = \frac{S_{1y}}{(S_{11}SS_T)^{1/2}} = \frac{2473.3440}{\sqrt{(1136.5600)(5784.53426)}} = 0.964615$$

$$r_{2y} = \frac{S_{2y}}{(S_{22}SS_T)^{1/2}} = \frac{108,038.6019}{\sqrt{(2,537,935.0330)(5784.5426)}} = 0.891670$$

and the correlation matrix for this problem is

$$\mathbf{W}'\mathbf{W} = \begin{bmatrix} 1 & 0.824215 \\ 0.824215 & 1 \end{bmatrix}$$

The normal equations in terms of the standardized regression coefficients are

$$\begin{bmatrix} 1 & 0.824215 \\ 0.824215 & 1 \end{bmatrix} \begin{bmatrix} \hat{b}_1 \\ \hat{b}_2 \end{bmatrix} = \begin{bmatrix} 0.964615 \\ 0.891670 \end{bmatrix}$$

Consequently, the standardized regression coefficients are

$$\begin{aligned} \begin{bmatrix} \hat{b}_1 \\ \hat{b}_2 \end{bmatrix} &= \begin{bmatrix} 1 & 0.824215 \\ 0.824215 & 1 \end{bmatrix}^{-1} \begin{bmatrix} 0.964615 \\ 0.891670 \end{bmatrix} \\ &= \begin{bmatrix} 3.11841 & -2.57023 \\ -2.57023 & 3.11841 \end{bmatrix} \begin{bmatrix} 0.964615 \\ 0.891670 \end{bmatrix} \\ &= \begin{bmatrix} 0.716267 \\ 0.301311 \end{bmatrix} \end{aligned}$$

The fitted model is

$$\hat{y}^0 = 0.716267w_1 + 0.301311w_2$$

Thus, increasing the standardized value of cases w_1 by one unit increases the standardized value of time \hat{y}^0 by 0.716267. Furthermore, increasing the standardized value of distance w_2 by one unit increases \hat{y}^0 by 0.301311 unit. Therefore, it seems that the volume of product delivered is more important than the distance in that it has a larger effect on delivery time in terms of the standardized variables. However, we should be somewhat cautious in reaching this conclusion, as \hat{b}_1 and \hat{b}_2 are still **partial** regression coefficients, and \hat{b}_1 and \hat{b}_2 are affected by the spread in the regressors. That is, if we took another sample with a different range of values for cases and distance, we might draw different conclusions about the relative importance of these regressors. ■

3.10 MULTICOLLINEARITY

Regression models are used for a wide variety of applications. A serious problem that may dramatically impact the usefulness of a regression model is **multicollinearity**, or **near-linear dependence** among the regression variables. In this section we briefly introduce the problem and point out some of the harmful effects of multicollinearity. A more extensive presentation, including more information on diagnostics and remedial measures, is in Chapter 9.

Multicollinearity implies near-linear dependence among the regressors. The regressors are the columns of the \mathbf{X} matrix, so clearly an **exact linear dependence** would result in a **singular $\mathbf{X}'\mathbf{X}$** . The presence of near-linear dependencies can dramatically impact the ability to estimate regression coefficients. For example, consider the regression data shown in Figure 3.12.

In Section 3.8 we introduced standardized regression coefficients. Suppose we use the **unit length** scaling [Eqs. (3.59) and (3.60)] for the data in Figure 3.12 so that the $\mathbf{X}'\mathbf{X}$ matrix (called $\mathbf{W}'\mathbf{W}$ in Section 3.8) will be in the form of a correlation matrix. This results in

$$\mathbf{W}'\mathbf{W} = \begin{bmatrix} 1 & 0 \\ 0 & 1 \end{bmatrix} \quad \text{and} \quad (\mathbf{W}'\mathbf{W})^{-1} = \begin{bmatrix} 1 & 0 \\ 0 & 1 \end{bmatrix}$$

For the soft drink delivery time data, we showed in Example 3.14 that

$$\mathbf{W}'\mathbf{W} = \begin{bmatrix} 1.00000 & 0.824215 \\ 0.824215 & 1.00000 \end{bmatrix} \quad \text{and} \quad (\mathbf{W}'\mathbf{W})^{-1} = \begin{bmatrix} 3.11841 & -2.57023 \\ -2.57023 & 3.11841 \end{bmatrix}$$

Now consider the variances of the standardized regression coefficients \hat{b}_1 and \hat{b}_2 for the two data sets. For the hypothetical data set in Figure 3.12.

$$\frac{\text{Var}(\hat{b}_1)}{\sigma^2} = \frac{\text{Var}(\hat{b}_2)}{\sigma^2} = 1$$

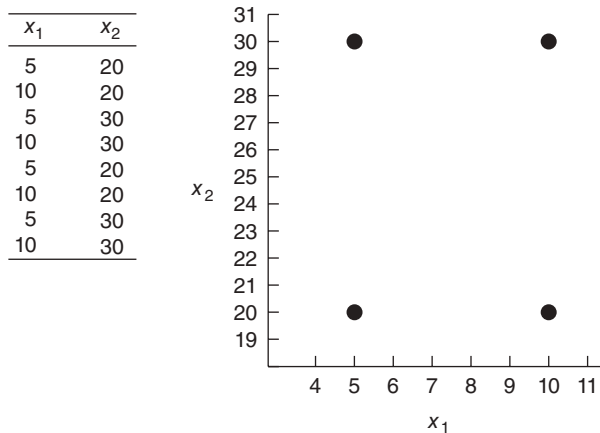

Figure 3.12 Data on two regressors.

while for the soft drink delivery time data

$$\frac{\text{Var}(\hat{b}_1)}{\sigma^2} = \frac{\text{Var}(\hat{b}_2)}{\sigma^2} = 3.11841$$

In the soft drink delivery time data the variances of the regression coefficients are **inflated** because of the multicollinearity. This multicollinearity is evident from the nonzero off-diagonal elements in $\mathbf{W}'\mathbf{W}$. These off-diagonal elements are usually called simple correlations between the regressors, although the term **correlation** may not be appropriate unless the x 's are random variables. The off-diagonals do provide a measure of linear dependency between regressors. Thus, multicollinearity can seriously affect the precision with which regression coefficients are estimated.

The main diagonal elements of the inverse of the $\mathbf{X}'\mathbf{X}$ matrix in correlation form [$(\mathbf{W}'\mathbf{W})^{-1}$ above] are often called **variance inflation factors** (VIFs), and they are an important multicollinearity diagnostic. For the soft drink data,

$$\text{VIF}_1 = \text{VIF}_2 = 3.11841$$

while for the hypothetical regressor data above,

$$\text{VIF}_1 = \text{VIF}_2 = 1$$

implying that the two regressors x_1 and x_2 are **orthogonal**. We can show that, in general, the VIF for the j th regression coefficient can be written as

$$\text{VIF}_j = \frac{1}{1 - R_j^2}$$

where R_j^2 is the coefficient of multiple determination obtained from regressing x_j on the other regressor variables. Clearly, if x_j is nearly linearly dependent on some of the other regressors, then R_j^2 will be near unity and VIF_j will be large. VIFs larger than 10 imply serious problems with multicollinearity. Most regression software computes and displays the VIF_j .

Regression models fit to data by the method of least squares when strong multicollinearity is present are notoriously poor prediction equations, and the values of the regression coefficients are often very sensitive to the data in the particular sample collected. The illustration in Figure 3.13a will provide some insight regarding these effects of multicollinearity. Building a regression model to the (x_1, x_2, y) data in Figure 3.13a is analogous to placing a plane through the dots. Clearly this plane will be very unstable and is sensitive to relatively small changes in the data points. Furthermore, the model may predict y 's at points similar to those observed in the sample reasonably well, but any extrapolation away from this path is likely to produce poor prediction. By contrast, examine the of **orthogonal regressors** in Figure 3.13b. The plane fit to these points will be more stable.

The diagnosis and treatment of multicollinearity is an important aspect of regression modeling. For a more in-depth treatment of the subject, refer to Chapter 9.

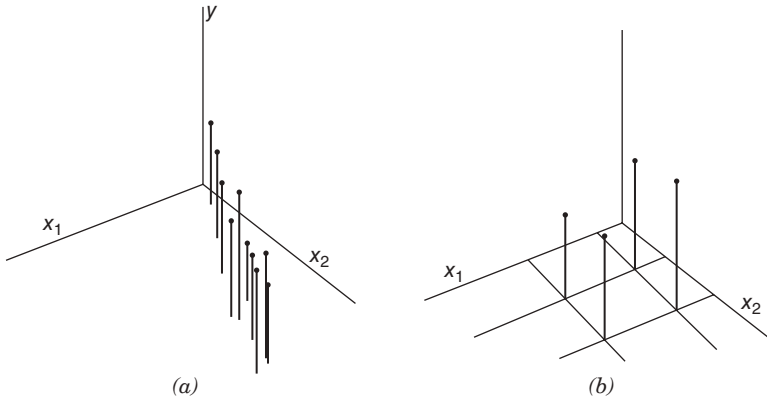

Figure 3.13 (a) A data set with multicollinearity. (b) Orthogonal regressors.

3.11 WHY DO REGRESSION COEFFICIENTS HAVE THE WRONG SIGN?

When using multiple regression, occasionally we find an apparent contradiction of intuition or theory when one or more of the regression coefficients seem to have the **wrong sign**. For example, the problem situation may imply that a particular regression coefficient should be positive, while the actual estimate of the parameter is negative. This “wrong”-sign problem can be disconcerting, as it is usually difficult to explain a negative estimate (say) of a parameter to the model user when that user believes that the coefficient should be positive. Mullet [1976] points out that regression coefficients may have the wrong sign for the following reasons:

1. The range of some of the regressors is too small.
2. Important regressors have not been included in the model.
3. Multicollinearity is present.
4. Computational errors have been made.

It is easy to see how the range of the x 's can affect the sign of the regression coefficients. Consider the simple linear regression model. The variance of the regression coefficient $\hat{\beta}_1$ is $\text{Var}(\hat{\beta}_1) = \sigma^2 / S_{xx} = \sigma^2 / \sum_{i=1}^n (x_i - \bar{x})^2$. Note that the variance of $\hat{\beta}_1$ is inversely proportional to the “spread” of the regressor. Therefore, if the levels of x are all close together, the variance of $\hat{\beta}_1$ will be relatively large. In some cases the variance of $\hat{\beta}_1$ could be so large that a negative estimate (for example) of a regression coefficient that is really positive results. The situation is illustrated in Figure 3.14, which plots the sampling distribution of $\hat{\beta}_1$. Examining this figure, we see that the probability of obtaining a negative estimate of $\hat{\beta}_1$ depends on how close the true regression coefficient is to zero and the variance of $\hat{\beta}_1$, which is greatly influenced by the spread of the x 's.

In some situations the analyst can control the levels of the regressors. Although it is possible in these cases to decrease the variance of the regression coefficients by increasing the range of the x 's, it may not be desirable to spread the levels of the regressors out too far. If the x 's cover too large a range and the true response

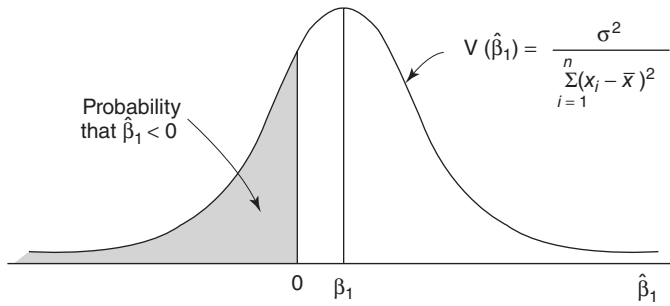

Figure 3.14 Sampling distribution of $\hat{\beta}_1$.

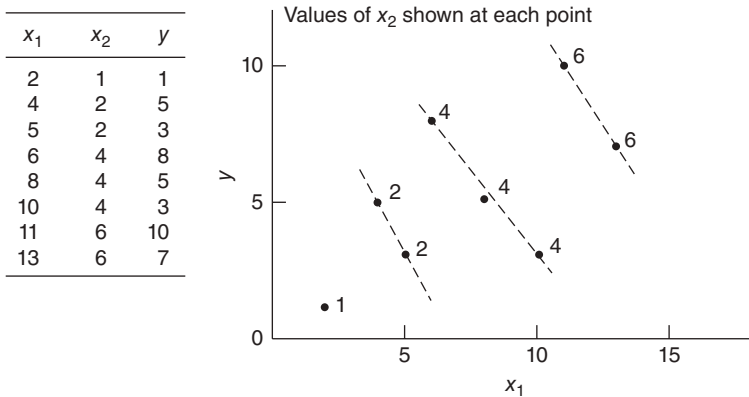

Figure 3.15 Plot of y versus x_1 .

function is nonlinear, the analyst may have to develop a much more complex equation to adequately model the curvature in the system. Furthermore, many problems involve a region of x space of specific interest to the experimenter, and spreading the regressors out beyond this region of interest may be impractical or impossible. In general, we must trade off the precision of estimation, the likely complexity of the model, and the values of the regressors of practical interest when deciding how far to spread out the x 's.

Wrong signs can also occur when important regressors have been left out of the model. In these cases the sign is not really wrong. The partial nature of the regression coefficients cause the sign reversal. To illustrate, consider the data in Figure 3.15.

Suppose we fit a model involving only y and x_1 . The equation is

$$\hat{y} = 1.835 + 0.463x_1$$

where $\hat{\beta}_1 = 0.463$ is a "total" regression coefficient. That is, it measures the total effect of x_1 ignoring the information content in x_2 . The model involving both x_1 and x_2 is

$$\hat{y} = 1.036 - 1.222x_1 + 3.649x_2$$

Note that now $\hat{\beta}_1 = -1.222$, and a sign reversal has occurred. The reason is that $\hat{\beta}_1 = -1.222$ in the multiple regression model is a partial regression coefficient; it measures the effect of x_1 **given** that x_2 is also in the model.

The data from this example are plotted in Figure 3.15. The reason for the difference in sign between the partial and total regression coefficients is obvious from inspection of this figure. If we ignore the x_2 values, the apparent relationship between y and x_1 has a positive slope. However, if we consider the relationship between y and x_1 for constant values of x_2 , we note that this relationship really has a negative slope. Thus, a wrong sign in a regression model may indicate that important regressors are missing. If the analyst can identify these regressors and include them in the model, then the wrong signs may disappear.

Multicollinearity can cause wrong signs for regression coefficients. In effect, severe multicollinearity inflates the variances of the regression coefficients, and this increases the probability that one or more regression coefficients will have the wrong sign. Methods for diagnosing and dealing with multicollinearity are summarized in Chapter 9.

Computational error is also a source of wrong signs in regression models. Different computer programs handle round-off or truncation problems in different ways, and some programs are more effective than others in this regard. Severe multicollinearity causes the $\mathbf{X}'\mathbf{X}$ matrix to be ill-conditioned, which is also a source of computational error. Computational error can cause not only sign reversals but regression coefficients to differ by several orders of magnitude. The accuracy of the computer code should be investigated when wrong-sign problems are suspected.

PROBLEMS

- 3.1** Consider the National Football League data in Table B.1.
- Fit a multiple linear regression model relating the number of games won to the team's passing yardage (x_2), the percentage of rushing plays (x_7), and the opponents' yards rushing (x_8).
 - Construct the analysis-of-variance table and test for significance of regression.
 - Calculate t statistics for testing the hypotheses $H_0: \beta_2 = 0$, $H_0: \beta_7 = 0$, and $H_0: \beta_8 = 0$. What conclusions can you draw about the roles the variables x_2 , x_7 , and x_8 play in the model?
 - Calculate R^2 and R_{Adj}^2 for this model.
 - Using the partial F test, determine the contribution of x_7 to the model. How is this partial F statistic related to the t test for β_7 calculated in part c above?
- 3.2** Using the results of Problem 3.1, show numerically that the square of the simple correlation coefficient between the observed values y_i and the fitted values \hat{y}_i equals R^2 .
- 3.3** Refer to Problem 3.1.
- Find a 95% CI on β_7 .
 - Find a 95% CI on the mean number of games won by a team when $x_2 = 2300$, $x_7 = 56.0$, and $x_8 = 2100$.

- 3.4** Reconsider the National Football League data from Problem 3.1. Fit a model to these data using only x_7 and x_8 as the regressors.
- Test for significance of regression.
 - Calculate R^2 and R_{Adj}^2 . How do these quantities compare to the values computed for the model in Problem 3.1, which included an additional regressor (x_2)?
 - Calculate a 95% CI on β_7 . Also find a 95% CI on the mean number of games won by a team when $x_7 = 56.0$ and $x_8 = 2100$. Compare the lengths of these CIs to the lengths of the corresponding CIs from Problem 3.3.
 - What conclusions can you draw from this problem about the consequences of omitting an important regressor from a model?
- 3.5** Consider the gasoline mileage data in Table B.3.
- Fit a multiple linear regression model relating gasoline mileage y (miles per gallon) to engine displacement x_1 and the number of carburetor barrels x_6 .
 - Construct the analysis-of-variance table and test for significance of regression.
 - Calculate R^2 and R_{Adj}^2 for this model. Compare this to the R^2 and the R_{Adj}^2 for the simple linear regression model relating mileage to engine displacement in Problem 2.4.
 - Find a 95% CI for β_1 .
 - Compute the t statistics for testing $H_0: \beta_1 = 0$ and $H_0: \beta_6 = 0$. What conclusions can you draw?
 - Find a 95% CI on the mean gasoline mileage when $x_1 = 275 \text{ in.}^3$ and $x_6 = 2$ barrels.
 - Find a 95% prediction interval for a new observation on gasoline mileage when $x_1 = 257 \text{ in.}^3$ and $x_6 = 2$ barrels.
- 3.6** In Problem 2.4 you were asked to compute a 95% CI on mean gasoline prediction interval on mileage when the engine displacement $x_1 = 275 \text{ in.}^3$. Compare the lengths of these intervals to the lengths of the confidence and prediction intervals from Problem 3.5 above. Does this tell you anything about the benefits of adding x_6 to the model?
- 3.7** Consider the house price data in Table B.4.
- Fit a multiple regression model relating selling price to all nine regressors.
 - Test for significance of regression. What conclusions can you draw?
 - Use t tests to assess the contribution of each regressor to the model. Discuss your findings.
 - What is the contribution of lot size and living space to the model given that all of the other regressors are included?
 - Is multicollinearity a potential problem in this model?
- 3.8** The data in Table B.5 present the performance of a chemical process as a function of several controllable process variables.
- Fit a multiple regression model relating CO_2 product (y) to total solvent (x_6) and hydrogen consumption (x_7).

- b. Test for significance of regression. Calculate R^2 and R_{Adj}^2 .
 - c. Using t tests determine the contribution of x_6 and x_7 to the model.
 - d. Construct 95% CIs on β_6 and β_7 .
 - e. Refit the model using only x_6 as the regressor. Test for significance of regression and calculate R^2 and R_{Adj}^2 . Discuss your findings. Based on these statistics, are you satisfied with this model?
 - f. Construct a 95% CI on β_6 using the model you fit in part e. Compare the length of this CI to the length of the CI in part d. Does this tell you anything important about the contribution of x_7 to the model?
 - g. Compare the values of MS_{Res} obtained for the two models you have fit (parts a and e). How did the MS_{Res} change when you removed x_7 from the model? Does this tell you anything important about the contribution of x_7 to the model?
- 3.9** The concentration of NbOCl_3 in a tube-flow reactor as a function of several controllable variables is shown in Table B.6.
- a. Fit a multiple regression model relating concentration of NbOCl_3 (y) to concentration of COCl_2 , (x_1) and mole fraction (x_4).
 - b. Test for significance of regression.
 - c. Calculate R^2 and R_{Adj}^2 for this model.
 - d. Using t tests, determine the contribution of x_1 and x_4 to the model. Are both regressors x_1 and x_4 necessary?
 - e. Is multicollinearity a potential concern in this model?
- 3.10** The quality of Pinot Noir wine is thought to be related to the properties of clarity, aroma, body, flavor, and oakiness. Data for 38 wines are given in Table B.11.
- a. Fit a multiple linear regression model relating wine quality to these regressors.
 - b. Test for significance of regression. What conclusions can you draw?
 - c. Use t tests to assess the contribution of each regressor to the model. Discuss your findings.
 - d. Calculate R^2 and R_{Adj}^2 for this model. Compare these values to the R^2 and R_{Adj}^2 for the linear regression model relating wine quality to aroma and flavor. Discuss your results.
 - e. Find a 95% CI for the regression coefficient for flavor for both models in part d. Discuss any differences.
- 3.11** An engineer performed an experiment to determine the effect of CO_2 pressure, CO_2 temperature, peanut moisture, CO_2 flow rate, and peanut particle size on the total yield of oil per batch of peanuts. Table B.7 summarizes the experimental results.
- a. Fit a multiple linear regression model relating yield to these regressors.
 - b. Test for significance of regression. What conclusions can you draw?
 - c. Use t tests to assess the contribution of each regressor to the model. Discuss your findings.
 - d. Calculate R^2 and R_{Adj}^2 for this model. Compare these values to the R^2 and R_{Adj}^2 for the multiple linear regression model relating yield to temperature and particle size. Discuss your results.

- e. Find a 95% CI for the regression coefficient for temperature for both models in part d. Discuss any differences.
- 3.12** A chemical engineer studied the effect of the amount of surfactant and time on clathrate formation. Clathrates are used as cool storage media. Table B.8 summarizes the experimental results.
- Fit a multiple linear regression model relating clathrate formation to these regressors.
 - Test for significance of regression. What conclusions can you draw?
 - Use t tests to assess the contribution of each regressor to the model. Discuss your findings.
 - Calculate R^2 and R_{Adj}^2 for this model. Compare these values to the R^2 and R_{Adj}^2 for the simple linear regression model relating clathrate formation to time. Discuss your results.
 - Find a 95% CI for the regression coefficient for time for both models in part d. Discuss any differences.
- 3.13** An engineer studied the effect of four variables on a dimensionless factor used to describe pressure drops in a screen-plate bubble column. Table B.9 summarizes the experimental results.
- Fit a multiple linear regression model relating this dimensionless number to these regressors.
 - Test for significance of regression. What conclusions can you draw?
 - Use t tests to assess the contribution of each regressor to the model. Discuss your findings.
 - Calculate R^2 and R_{Adj}^2 for this model. Compare these values to the R^2 and R_{Adj}^2 for the multiple linear regression model relating the dimensionless number to x_2 and x_3 . Discuss your results.
 - Find a 99% CI for the regression coefficient for x_2 for both models in part d. Discuss any differences.
- 3.14** The kinematic viscosity of a certain solvent system depends on the ratio of the two solvents and the temperature. Table B.10 summarizes a set of experimental results.
- Fit a multiple linear regression model relating the viscosity to the two regressors.
 - Test for significance of regression. What conclusions can you draw?
 - Use t tests to assess the contribution of each regressor to the model. Discuss your findings.
 - Calculate R^2 and R_{Adj}^2 for this model. Compare these values to the R^2 and R_{Adj}^2 for the simple linear regression model relating the viscosity to temperature only. Discuss your results.
 - Find a 99% CI for the regression coefficient for temperature for both models in part d. Discuss any differences.
- 3.15** McDonald and Ayers [1978] present data from an early study that examined the possible link between air pollution and mortality. Table B.15 summarizes the data. The response MORT is the total age-adjusted mortality from all

causes, in deaths per 100,000 population. The regressor PRECIP is the mean annual precipitation (in inches), EDUC is the median number of school years completed for persons of age 25 years or older, NONWHITE is the percentage of the 1960 population that is nonwhite, NOX is the relative pollution potential of oxides of nitrogen, and SO₂ is the relative pollution potential of sulfur dioxide. “Relative pollution potential” is the product of the tons emitted per day per square kilometer and a factor correcting the SMSA dimensions and exposure.

- a. Fit a multiple linear regression model relating the mortality rate to these regressors.
 - b. Test for significance of regression. What conclusions can you draw?
 - c. Use t tests to assess the contribution of each regressor to the model. Discuss your findings.
 - d. Calculate R^2 and R_{Adj}^2 for this model.
 - e. Find a 95% CI for the regression coefficient for SO₂.
- 3.16** Rossman [1994] presents an interesting study of average life expectancy of 40 countries. Table B.16 gives the data. The study has three responses: LifeExp is the overall average life expectancy. LifeExpMale is the average life expectancy for males, and LifeExpFemale is the average life expectancy for females. The regressors are People-per-TV, which is the average number of people per television, and People-per-Dr, which is the average number of people per physician.
- a. Fit different multiple linear regression models for each response.
 - b. Test each model for significance of regression. What conclusions can you draw?
 - c. Use t tests to assess the contribution of each regressor to each model. Discuss your findings.
 - d. Calculate R^2 and R_{Adj}^2 for each model.
 - e. Find a 95% CI for the regression coefficient for People-per-Dr in each model.
- 3.17** Consider the patient satisfaction data in Table B.17. For the purposes of this exercise, ignore the regressor “Medical-Surgical.” Perform a thorough analysis of these data. Please discuss any differences from the analyses outlined in Sections 2.7 and 3.6.
- 3.18** Consider the fuel consumption data in Table B.18. For the purposes of this exercise, ignore regressor x_1 . Perform a thorough analysis of these data. What conclusions do you draw from this analysis?
- 3.19** Consider the wine quality of young red wines data in Table B.19. For the purposes of this exercise, ignore regressor x_1 . Perform a thorough analysis of these data. What conclusions do you draw from this analysis?
- 3.20** Consider the methanol oxidation data in Table B.20. Perform a thorough analysis of these data. What conclusions do you draw from this analysis?
- 3.21** A chemical engineer is investigating how the amount of conversion of a product from a raw material (y) depends on reaction temperature (x_1) and reaction time (x_2). He has developed the following regression models:

1. $\hat{y} = 100 + 0.2x_1 + 4x_2$
2. $\hat{y} = 95 + 0.15x_1 + 3x_2 + 1x_1x_2$

Both models have been built over the range $20 \leq x_1 \leq 50$ ($^{\circ}\text{C}$) and $0.5 \leq x_2 \leq 10$ (hours).

- a. Using both models, what is the predicted value of conversion when $x_2 = 2$ in terms of x_1 ? Repeat this calculation for $x_2 = 8$. Draw a graph of the predicted values as a function of temperature for both conversion models. Comment on the effect of the interaction term in model 2.
 - b. Find the expected change in the mean conversion for a unit change in temperature x_1 for model 1 when $x_2 = 5$. Does this quantity depend on the specific value of reaction time selected? Why?
 - c. Find the expected change in the mean conversion for a unit change in temperature x_1 for model 2 when $x_2 = 5$. Repeat this calculation for $x_2 = 2$ and $x_2 = 8$. Does the result depend on the value selected for x_2 ? Why?
- 3.22** Show that an equivalent way to perform the test for significance of regression in multiple linear regression is to base the test on R^2 as follows: To test $H_0: \beta_1 = \beta_2 = \dots = \beta_k$ versus H_1 : at least one $\beta_j \neq 0$, calculate

$$F_0 = \frac{R^2(n-p)}{k(1-R^2)}$$

and to reject H_0 if the computed value of F_0 exceeds $F_{\alpha, k, n-p}$, where $p = k + 1$.

- 3.23** Suppose that a linear regression model with $k = 2$ regressors has been fit to $n = 25$ observations and $R^2 = 0.90$.
- a. Test for significance of regression at $\alpha = 0.05$. Use the results of the previous problem.
 - b. What is the smallest value of R^2 that would lead to the conclusion of a significant regression if $\alpha = 0.05$? Are you surprised at how small this value of R^2 is?
- 3.24** Show that an alternate computing formula for the regression sum of squares in a linear regression model is

$$SS_R = \sum_{i=1}^n \hat{y}_i^2 - n\bar{y}^2$$

- 3.25** Consider the multiple linear regression model

$$y = \beta_0 + \beta_1x_1 + \beta_2x_2 + \beta_3x_3 + \beta_4x_4 + \varepsilon$$

Using the procedure for testing a general linear hypothesis, show how to test

- a. $H_0: \beta_1 = \beta_2 = \beta_3 = \beta_4 = \beta$
- b. $H_0: \beta_1 = \beta_2, \beta_3 = \beta_4$
- c. $H_0: \beta_1 - 2\beta_2 = 4\beta_3$
 $\beta_1 + 2\beta_2 = 0$

3.26 Suppose that we have two independent samples, say

$$\begin{array}{cc}
 \begin{array}{c} \underline{y} \quad \underline{x} \\ y_1 \quad x_1 \\ y_2 \quad x_2 \\ \vdots \quad \vdots \\ y_{n_1} \quad x_{n_1} \end{array} & \left. \vphantom{\begin{array}{c} \underline{y} \quad \underline{x} \\ y_1 \quad x_1 \\ y_2 \quad x_2 \\ \vdots \quad \vdots \\ y_{n_1} \quad x_{n_1} \end{array}} \right\} \text{Sample 1} \\
 \begin{array}{c} \underline{y} \quad \underline{x} \\ y_{n_1+1} \quad x_{n_1+1} \\ \vdots \quad \vdots \\ y_{n_1+n_2} \quad x_{n_1+n_2} \end{array} & \left. \vphantom{\begin{array}{c} \underline{y} \quad \underline{x} \\ y_{n_1+1} \quad x_{n_1+1} \\ \vdots \quad \vdots \\ y_{n_1+n_2} \quad x_{n_1+n_2} \end{array}} \right\} \text{Sample 2}
 \end{array}$$

Two models can be fit to these samples,

$$\begin{aligned}
 y_i &= \beta_0 + \beta_1 x_i + \varepsilon_i, \quad i = 1, 2, \dots, n_2 \\
 y_i &= \gamma_0 + \gamma_1 x_i + \varepsilon_i, \quad i = n_1 + 1, n_1 + 2, \dots, n_1 + n_2
 \end{aligned}$$

- a. Show how these two separate models can be written as a single model.
- b. Using the result in part a, show how the general linear hypothesis can be used to test the equality of slopes β_1 and γ_1 .
- c. Using the result in part a, show how the general linear hypothesis can be used to test the equality of the two regression lines.
- d. Using the result in part a, show how the general linear hypothesis can be used to test that both slopes are equal to a constant c .

3.27 Show that $\text{Var}(\hat{\mathbf{y}}) = \sigma^2 \mathbf{H}$.

3.28 Prove that the matrices \mathbf{H} and $\mathbf{I} - \mathbf{H}$ are idempotent, that is, $\mathbf{H}\mathbf{H} = \mathbf{H}$ and $(\mathbf{I} - \mathbf{H})(\mathbf{I} - \mathbf{H}) = \mathbf{I} - \mathbf{H}$.

3.29 For the simple linear regression model, show that the elements of the hat matrix are

$$h_{ij} = \frac{1}{n} + \frac{(x_i - \bar{x})(x_j - \bar{x})}{S_{xx}} \quad \text{and} \quad h_{ii} = \frac{1}{n} + \frac{(x_i - \bar{x})^2}{S_{xx}}$$

Discuss the behavior of these quantities as x_i moves farther from \bar{x} ,

3.30 Consider the multiple linear regression model $\mathbf{y} = \mathbf{X}\boldsymbol{\beta} + \boldsymbol{\varepsilon}$. Show that the least-squares estimator can be written as

$$\hat{\boldsymbol{\beta}} = \boldsymbol{\beta} + \mathbf{R}\boldsymbol{\varepsilon} \quad \text{where} \quad \mathbf{R} = (\mathbf{X}'\mathbf{X})^{-1} \mathbf{X}'$$

3.31 Show that the residuals from a linear regression model can be expressed as $\mathbf{e} = (\mathbf{I} - \mathbf{H})\boldsymbol{\varepsilon}$. [Hint: Refer to Eq. (3.15b).]

3.32 For the multiple linear regression model, show that $SS_R(\boldsymbol{\beta}) = \mathbf{y}'\mathbf{H}\mathbf{y}$.

3.33 Prove that R^2 is the square of the correlation between \mathbf{y} and $\hat{\mathbf{y}}$.

3.34 **Constrained least squares.** Suppose we wish to find the least-squares estimator of $\boldsymbol{\beta}$ in the model $\mathbf{y} = \mathbf{X}\boldsymbol{\beta} + \boldsymbol{\varepsilon}$ subject to a set of equality constraints on $\boldsymbol{\beta}$, say $\mathbf{T}\boldsymbol{\beta} = \mathbf{c}$. Show that the estimator is

$$\tilde{\beta} = \hat{\beta} + (\mathbf{X}'\mathbf{X})^{-1} \mathbf{T}' [\mathbf{T}(\mathbf{X}'\mathbf{X})^{-1} \mathbf{T}]^{-1} (\mathbf{c} - \mathbf{T}\hat{\beta})$$

where $\hat{\beta} = (\mathbf{X}'\mathbf{X})^{-1} \mathbf{X}'\mathbf{y}$. Discuss situations in which this constrained estimator might be appropriate. Find the residual sum of squares for the constrained estimator. Is it larger or smaller than the residual sum of squares in the unconstrained case?

- 3.35 Let \mathbf{x}_j be the j th row of \mathbf{X} , and \mathbf{X}_{-j} be the \mathbf{X} matrix with the j th row removed. Show that

$$\text{Var}[\hat{\beta}_j] = \sigma^2 [\mathbf{x}'_j \mathbf{x}_j - \mathbf{x}'_j \mathbf{X}_{-j} (\mathbf{X}'_{-j} \mathbf{X}_{-j})^{-1} \mathbf{X}'_{-j} \mathbf{x}_j]$$

- 3.36 Consider the following two models where $E(\boldsymbol{\varepsilon}) = \mathbf{0}$ and $\text{Var}(\boldsymbol{\varepsilon}) = \sigma^2 \mathbf{I}$:

Model A: $\mathbf{y} = \mathbf{X}_1 \boldsymbol{\beta}_1 + \boldsymbol{\varepsilon}$

Model B: $\mathbf{y} = \mathbf{X}'_1 \boldsymbol{\beta}_1 + \mathbf{X}_2 \boldsymbol{\beta}_2 + \boldsymbol{\varepsilon}$

Show that $R_A^2 \leq R_B^2$.

- 3.37 Suppose we fit the model $\mathbf{y} = \mathbf{X}_1 \boldsymbol{\beta}_2 + \boldsymbol{\varepsilon}$ when the true model is actually given by $\mathbf{y} = \mathbf{X}_1 \boldsymbol{\beta}_2 + \mathbf{X}_2 \boldsymbol{\beta}_2 + \boldsymbol{\varepsilon}$. For both models, assume $E(\boldsymbol{\varepsilon}) = \mathbf{0}$ and $\text{Var}(\boldsymbol{\varepsilon}) = \sigma^2 \mathbf{I}$. Find the expected value and variance of the ordinary least-squares estimate, $\hat{\beta}_1$. Under what conditions is this estimate unbiased?

- 3.38 Consider a correctly specified regression model with p terms, including the intercept. Make the usual assumptions about $\boldsymbol{\varepsilon}$. Prove that

$$\sum_{i=1}^n \text{Var}(\hat{y}_i) = p\sigma^2$$

- 3.39 Let R_j^2 be the coefficient of determination when we regress the j th regressor on the other $k - 1$ regressors. Show that the j th variance inflation factor may be expressed as

$$\frac{1}{1 - R_j^2}$$

- 3.40 Consider the hypotheses for the general linear model, which are of the form

$$H_0: \mathbf{T}\boldsymbol{\beta} = \mathbf{c}, \quad H_1: \mathbf{T}\boldsymbol{\beta} \neq \mathbf{c}$$

where \mathbf{T} is a $q \times p$ matrix of rank q . Derive the appropriate F statistic under both the null and alternative hypothesis.

CHAPTER 4

MODEL ADEQUACY CHECKING

4.1 INTRODUCTION

The major **assumptions** that we have made thus far in our study of regression analysis are as follows:

1. The relationship between the response y and the regressors is linear, at least approximately.
2. The error term ε has zero mean.
3. The error term ε has constant variance σ^2 .
4. The errors are uncorrelated.
5. The errors are normally distributed.

Taken together, assumptions 4 and 5 imply that the errors are independent random variables. Assumption 5 is required for hypothesis testing and interval estimation.

We should always consider the validity of these assumptions to be doubtful and conduct analyses to examine the adequacy of the model we have tentatively entertained. The types of model inadequacies discussed here have potentially serious consequences. Gross violations of the assumptions may yield an unstable model in the sense that a different sample could lead to a totally different model with opposite conclusions. We usually cannot detect departures from the underlying assumptions by examination of the standard summary statistics, such as the t or F statistics, or R^2 . These are “global” model properties, and as such they do not ensure model adequacy.

In this chapter we present several methods useful for diagnosing violations of the basic regression assumptions. These diagnostic methods are primarily based on study of the model **residuals**. Methods for dealing with model inadequacies, as well as additional, more sophisticated diagnostics, are discussed in Chapters 5 and 6.

4.2 RESIDUAL ANALYSIS

4.2.1 Definition of Residuals

We have previously defined the residuals as

$$e_i = y_i - \hat{y}_i, \quad i = 1, 2, \dots, n \quad (4.1)$$

where y_i is an observation and \hat{y}_i is the corresponding fitted value. Since a residual may be viewed as the **deviation** between the **data** and the **fit**, it is also a measure of the variability in the response variable not explained by the regression model. It is also convenient to think of the residuals as the realized or observed values of the model errors. Thus, any departures from the assumptions on the errors should show up in the residuals. Analysis of the residuals is an effective way to discover several types of model inadequacies. As we will see, **plotting residuals** is a very effective way to investigate how well the regression model fits the data and to check the assumptions listed in Section 4.1.

The residuals have several important properties. They have zero mean, and their approximate average variance is estimated by

$$\frac{\sum_{i=1}^n (e_i - \bar{e})^2}{n - p} = \frac{\sum_{i=1}^n e_i^2}{n - p} = \frac{SS_{\text{Res}}}{n - p} = MS_{\text{Res}}$$

The residuals are not independent, however, as the n residuals have only $n - p$ degrees of freedom associated with them. This nonindependence of the residuals has little effect on their use for model adequacy checking as long as n is not small relative to the number of parameters p .

4.2.2 Methods for Scaling Residuals

Sometimes it is useful to work with **scaled residuals**. In this section we introduce four popular methods for scaling residuals. These scaled residuals are helpful in finding observations that are **outliers**, or **extreme values**, that is, observations that are separated in some fashion from the rest of the data. See Figures 2.6–2.8 for examples of outliers and extreme values.

Standardized Residuals Since the approximate average variance of a residual is estimated by MS_{Res} , a logical scaling for the residuals would be the **standardized residuals**

$$d_i = \frac{e_i}{\sqrt{MS_{\text{Res}}}}, \quad i = 1, 2, \dots, n \quad (4.2)$$

The standardized residuals have mean zero and approximately unit variance. Consequently, a large standardized residual ($d_i > 3$, say) potentially indicates an outlier.

Studentized Residuals Using MS_{Res} as the variance of the i th residual, e_i is only an approximation. We can improve the residual scaling by dividing e_i by the exact standard deviation of the i th residual. Recall from Eq. (3.15b) that we may write the vector of residuals as

$$\mathbf{e} = (\mathbf{I} - \mathbf{H})\mathbf{y} \quad (4.3)$$

where $\mathbf{H} = \mathbf{X}(\mathbf{X}'\mathbf{X})^{-1}\mathbf{X}'$ is the **hat matrix**. The hat matrix has several useful properties. It is **symmetric** ($\mathbf{H}' = \mathbf{H}$) and **idempotent** ($\mathbf{H}\mathbf{H} = \mathbf{H}$). Similarly the matrix $\mathbf{I} - \mathbf{H}$ is symmetric and idempotent. Substituting $\mathbf{y} = \mathbf{X}\boldsymbol{\beta} + \boldsymbol{\varepsilon}$ into Eq. (4.3) yields

$$\begin{aligned} \mathbf{e} &= (\mathbf{I} - \mathbf{H})(\mathbf{X}\boldsymbol{\beta} + \boldsymbol{\varepsilon}) = \mathbf{X}\boldsymbol{\beta} - \mathbf{H}\mathbf{X}\boldsymbol{\beta} + (\mathbf{I} - \mathbf{H})\boldsymbol{\varepsilon} \\ &= \mathbf{X}\boldsymbol{\beta} - \mathbf{X}(\mathbf{X}'\mathbf{X})^{-1}\mathbf{X}'\mathbf{X}\boldsymbol{\beta} + (\mathbf{I} - \mathbf{H})\boldsymbol{\varepsilon} = (\mathbf{I} - \mathbf{H})\boldsymbol{\varepsilon} \end{aligned} \quad (4.4)$$

Thus, the residuals are the same linear transformation of the observations \mathbf{y} and the errors $\boldsymbol{\varepsilon}$.

The covariance matrix of the residuals is

$$\text{Var}(\mathbf{e}) = \text{Var}[(\mathbf{I} - \mathbf{H})\boldsymbol{\varepsilon}] = (\mathbf{I} - \mathbf{H})\text{Var}(\boldsymbol{\varepsilon})(\mathbf{I} - \mathbf{H})' = \sigma^2(\mathbf{I} - \mathbf{H}) \quad (4.5)$$

since $\text{Var}(\boldsymbol{\varepsilon}) = \sigma^2\mathbf{I}$ and $\mathbf{I} - \mathbf{H}$ is symmetric and idempotent. The matrix $\mathbf{I} - \mathbf{H}$ is generally not diagonal, so the residuals have different variances and they are correlated.

The variance of the i th residual is

$$\text{Var}(e_i) = \sigma^2(1 - h_{ii}) \quad (4.6)$$

where h_{ii} is the i th diagonal element of the hat matrix \mathbf{H} . The covariance between residuals e_i and e_j is

$$\text{Cov}(e_i, e_j) = -\sigma^2 h_{ij} \quad (4.7)$$

where h_{ij} is the ij th element of the hat matrix. Now since $0 \leq h_{ii} \leq 1$, using the residual mean square MS_{Res} to estimate the variance of the residuals actually overestimates $\text{Var}(e_i)$. Furthermore, since h_{ii} is a measure of the **location** of the i th point in x space (recall the discussion of hidden extrapolation in Section 3.7), the variance of e_i depends on where the point \mathbf{x}_i lies. Generally points near the center of the x space have larger variance (poorer least-squares fit) than residuals at more remote locations. Violations of model assumptions are more likely at remote points, and these violations may be hard to detect from inspection of the ordinary residuals e_i (or the standardized residuals d_i) because their residuals will usually be smaller.

Most students find it very counter-intuitive that the residuals for data points remote in terms of the x s are small, and in fact go to 0 as the remote points get

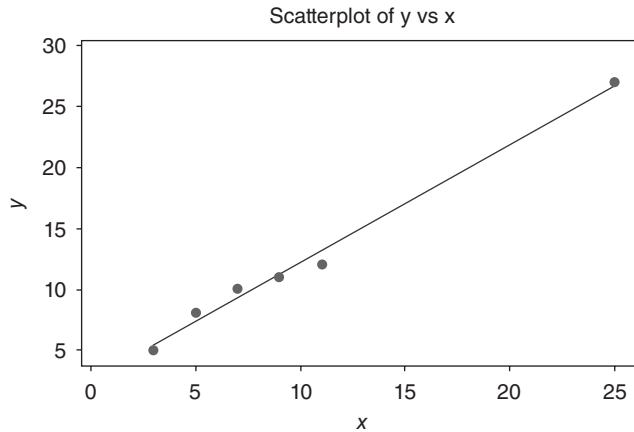

Figure 4.1 Example of a pure leverage point.

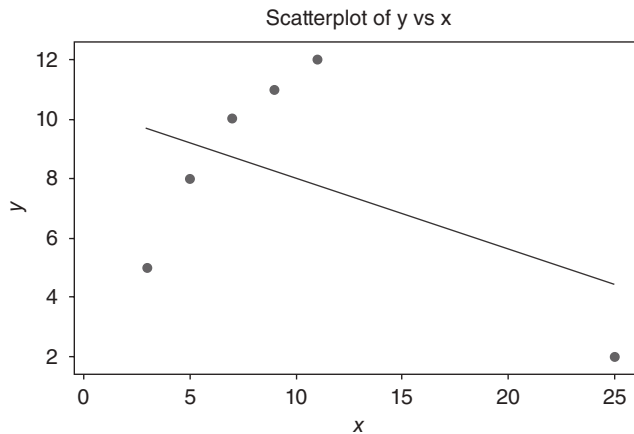

Figure 4.2 Example of an influential point.

further away from the center of the other points. Figures 4.1 and 4.2 help to illustrate this point. The only difference between these two plots occurs at $x = 25$. In Figure 4.1, the value of the response is 25, and in Figure 4.2, the value is 2. Figure 4.1 is a typical scatter plot for a pure **leverage** point. Such a point is remote in terms of the specific values of the regressors, but the observed value for the response is consistent with the prediction based on the other data values. The data point with $x = 25$ is an example of a pure leverage point. The line drawn on the figure is the actual ordinary least squares fit to the entire data set. Figure 4.2 is a typical scatter plot for an **influential** point. Such a data value is not only remote in terms of the specific values for the regressors, but the observed response is not consistent with the values that would be predicted based on only the other data points. Once again, the line drawn is the actual ordinary least squares fit to the entire data set. One can clearly see that the influential point draws the prediction equation to itself.

A little mathematics provides more insight into this situation. Let y_n be the observed response for the n^{th} data point, let x_n be the specific values for the regressors for this data point, let \hat{y}_n^* be the predicted value for the response based on the other $n - 1$ data points, and let $\delta = y_n - \hat{y}_n^*$ be the difference between the actually observed value for this response compared to the predicted value based on the other values. Please note that $y_n = \hat{y}_n^* + \delta$. If a data point is remote in terms of the regressor values and $|\delta|$ is large, then we have an influential point. In Figures 4.1 and 4.2, consider $x = 25$. Let y_n be 2, the value from Figure 4.2. The actual predicted value for the that response based on the other four data values is 25, which is the point illustrated in Figure 4.1. In this case, $\delta = -23$, and we see that it is a very influential point. Finally, let \hat{y}_n be the predicted value for the n^{th} response using all the data. It can be shown that

$$\hat{y}_n = \hat{y}_n^* + h_{nn}\delta$$

where h_{nn} is the n^{th} diagonal element of the hat matrix. If the n^{th} data point is remote in terms of the space defined by the data values for the regressors, then h_{nn} approaches 1, and \hat{y}_n approaches y_n . The remote data value “drags” the prediction to itself.

This point is easier to see within a simple linear regression example. Let \bar{x}^* be the average value for the other $n - 1$ regressors. It can be shown that

$$\hat{y}_n = \hat{y}_n^* + \left[\frac{1}{n} + \left(\frac{n-1}{n} \right)^2 \frac{(x_n - \bar{x}^*)^2}{S_{xx}} \right] \delta.$$

Clearly, for even a moderate sample size, as the data point becomes more remote in terms of the regressors (as x_n moves further away from \bar{x}^* , then the ordinary least squares estimate of y_n approaches the actually observed value for y_n).

The bottom line is two-fold. As we discussed in Sections 2.4 and 3.4, the prediction variance for data points that are remote in terms of the regressors is large. However, these data points do draw the prediction equation to themselves. As a result, the variance of the residuals for these points is small. This combination presents complications for doing proper residual analysis.

A logical procedure, then, is to examine the **studentized residuals**

$$r_i = \frac{e_i}{\sqrt{MS_{\text{Res}}(1 - h_{ii})}}, \quad i = 1, 2, \dots, n \quad (4.8)$$

instead of e_i (or d_i). The studentized residuals have constant variance $\text{Var}(r_i) = 1$ regardless of the location of \mathbf{x}_i when the form of the model is correct. In many situations the variance of the residuals stabilizes, particularly for large data sets. In these cases there may be little difference between the standardized and studentized residuals. Thus, standardized and studentized residuals often convey equivalent information. However, since any point with a large residual **and** a large h_{ii} is potentially highly influential on the least-squares fit, examination of the studentized residuals is generally recommended.

Some of these points are very easy to see by examining the studentized residuals for a simple linear regression model. If there is only one regressor, it is easy to show that the studentized residuals are

$$r_i = \frac{e_i}{\sqrt{MS_{\text{Res}} \left[1 - \left(\frac{1}{n} + \frac{(x_i - \bar{x})^2}{S_{xx}} \right) \right]}}, \quad i = 1, 2, \dots, n \quad (4.9)$$

Notice that when the observation x_i is close to the midpoint of the x data, $x_i - \bar{x}$ will be small, and the estimated standard deviation of e_i [the denominator of Eq. (4.9)] will be large. Conversely, when x_i is near the extreme ends of the range of the x data, $x_i - \bar{x}$ will be large, and the estimated standard deviation of e_i will be small. Also, when the sample size n is really large, the effect of $(x_i - \bar{x})^2$ will be relatively small, so in big data sets, studentized residuals may not differ dramatically from standardized residuals.

PRESS Residuals The standardized and studentized residuals are effective in detecting outliers. Another approach to making residuals useful in finding outliers is to examine the quantity that is computed from $y_i - \hat{y}_{(i)}$, where $\hat{y}_{(i)}$ is the fitted value of the i th response based on all observations except the i th one. The logic behind this is that if the i th observation y_i is really unusual, the regression model based on all observations may be overly influenced by this observation. This could produce a fitted value \hat{y}_i that is very similar to the observed value y_i , and consequently, the ordinary residual e_i will be small. Therefore, it will be hard to detect the outlier. However, if the i th observation is deleted, then $\hat{y}_{(i)}$ cannot be influenced by that observation, so the resulting residual should be likely to indicate the presence of the outlier.

If we delete the i th observation, fit the regression model to the remaining $n - 1$ observations, and calculate the predicted value of y_i corresponding to the deleted observation, the corresponding **prediction error** is

$$e_{(i)} = y_i - \hat{y}_{(i)} \quad (4.10)$$

This prediction error calculation is repeated for each observation $i = 1, 2, \dots, n$. These prediction errors are usually called **PRESS residuals** (because of their use in computing the prediction error sum of squares, discussed in Section 4.3). Some authors call the $e_{(i)}$ **deleted residuals**.

It would initially seem that calculating the PRESS residuals requires fitting n different regressions. However, it is possible to calculate PRESS residuals from the results of a single least-squares fit to all n observations. We show in Appendix C.7 how this is accomplished. It turns out that the i th PRESS residual is

$$e_{(i)} = \frac{e_i}{1 - h_{ii}}, \quad i = 1, 2, \dots, n \quad (4.11)$$

From Eq. (4.11) it is easy to see that the PRESS residual is just the ordinary residual weighted according to the diagonal elements of the hat matrix h_{ii} . Residuals associated with points for which h_{ii} is large will have large PRESS residuals. These points will generally be **high influence** points. Generally, a large difference between the ordinary residual and the PRESS residual will indicate a point where the model **fits** the data well, but a model built without that point **predicts** poorly. In Chapter 6, we discuss some other measures of influential observations.

Finally, the variance of the i th PRESS residual is

$$\text{Var}[e_{(i)}] = \text{Var}\left[\frac{e_i}{1-h_{ii}}\right] = \frac{1}{(1-h_{ii})^2}[\sigma^2(1-h_{ii})] = \frac{\sigma^2}{1-h_{ii}}$$

so that a **standardized** PRESS residual is

$$\frac{e_{(i)}}{\sqrt{\text{Var}[e_{(i)}]}} = \frac{e_i/(1-h_{ii})}{\sqrt{\sigma_i^2(1-h_{ii})}} = \frac{e_i}{\sqrt{\sigma^2(1-h_{ii})}}$$

which, if we use MS_{Res} to estimate σ^2 , is just the **studentized residual** discussed previously.

R-Student The studentized residual r_i discussed above is often considered an outlier diagnostic. It is customary to use MS_{Res} as an estimate of σ^2 in computing r_i . This is referred to as **internal scaling** of the residual because MS_{Res} is an internally generated estimate of σ^2 obtained from fitting the model to all n observations. Another approach would be to use an estimate of σ^2 based on a data set with the i th observation removed. Denote the estimate of σ^2 so obtained by $S_{(i)}^2$. We can show (see Appendix C.8) that

$$S_{(i)}^2 = \frac{(n-p)MS_{\text{Res}} - e_i^2/(1-h_{ii})}{n-p-1} \quad (4.12)$$

The estimate of σ^2 in Eq. (4.12) is used instead of MS_{Res} to produce an **externally studentized residual**, usually called **R-student**, given by

$$t_i = \frac{e_i}{\sqrt{S_{(i)}^2(1-h_{ii})}}, \quad i = 1, 2, \dots, n \quad (4.13)$$

In many situations t_i will differ little from the studentized residual r_i . However, if the i th observation is influential, then $S_{(i)}^2$ can differ significantly from MS_{Res} , and thus the R -student statistic will be more sensitive to this point.

It turns out that under the usual regression assumptions, t_i will follow the t_{n-p-1} distribution. Appendix C.9 establishes a formal hypothesis-testing procedure for outlier detection based on R -student. One could use a Bonferroni-type approach and compare all n values of $|t_i|$ to $t_{(\alpha/2n), n-p-1}$ to provide guidance regarding outliers. However, it is our view that a formal approach is usually not necessary and that only relatively crude cutoff values need be considered. In general, a **diagnostic view** as opposed to a strict statistical hypothesis-testing view is best. Furthermore, detection of outliers often needs to be considered simultaneously with detection of influential observations, as discussed in Chapter 6.

Example 4.1 The Delivery Time Data

Table 4.1 presents the scaled residuals discussed in this section using the model for the soft drink delivery time data developed in Example 3.1. Examining column

1 of Table 4.1 (the ordinary residuals, originally calculated in Table 3.3) we note that one residual, $e_9 = 7.4197$, seems suspiciously large. Column 2 shows that the standardized residual is $d_9 = e_9 / \sqrt{MS_{\text{Res}}} = 7.4197 / \sqrt{10.6239} = 2.2763$. All other standardized residuals are inside the ± 2 limits. Column 3 of Table 4.1 shows the studentized residuals. The studentized residual at point 9 is $r_9 = e_9 / \sqrt{MS_{\text{Res}}(1-h_{9,9})} = 7.4197 / \sqrt{10.6239(1-0.49829)} = 3.2138$, which is substantially larger than the standardized residual. As we noted in Example 3.13, point 9 has the largest value of x_1 (30 cases) and x_2 (1460 feet). If we take the remote location of point 9 into account when scaling its residual, we conclude that the model does not fit this point well. The diagonal elements of the hat matrix, which are used extensively in computing scaled residuals, are shown in column 4.

Column 5 of Table 4.1 contains the PRESS residuals. The PRESS residuals for points 9 and 22 are substantially larger than the corresponding ordinary residuals, indicating that these are likely to be points where the model fits reasonably well but does not provide good predictions of fresh data. As we have observed in Example 3.13, these points are remote from the rest of the sample.

Column 6 displays the values of R -student. Only one value, t_9 , is unusually large. Note that t_9 is larger than the corresponding studentized residual r_9 , indicating that when run 9 is set aside, $S_{(9)}^2$ is smaller than MS_{Res} , so clearly this run is influential. Note that $S_{(9)}^2$ is calculated from Eq. (4.12) as follows:

$$\begin{aligned} S_{(9)}^2 &= \frac{(n-p)MS_{\text{Res}} - e_9^2 / (1-h_{9,9})}{n-p-1} \\ &= \frac{(22)(10.6239) - (7.4197)^2 / (1-0.49829)}{21} \\ &= 5.9046 \end{aligned} \quad \blacksquare$$

4.2.3 Residual Plots

As mentioned previously, graphical analysis of residuals is a very effective way to investigate the adequacy of the fit of a regression model and to check the underlying assumptions. In this section, we introduce and illustrate the basic residual plots. These plots are typically generated by regression computer software packages. They should be examined routinely in all regression modeling problems. We often plot externally studentized residuals because they have constant variance.

Normal Probability Plot Small departures from the normality assumption do not affect the model greatly, but gross nonnormality is potentially more serious as the t or F statistics and confidence and prediction intervals depend on the normality assumption. Furthermore, if the errors come from a distribution with thicker or heavier tails than the normal, the least-squares fit may be sensitive to a small subset of the data. Heavy-tailed error distributions often generate outlier that “pull” the least-squares fit too much in their direction. In these cases other estimation techniques (such as the **robust regression** methods in Section 15.1 should be considered.

A very simple method of checking the normality assumption is to construct a **normal probability** plot of the residuals. This is a graph designed so that the cumula-

TABLE 4.1 Scaled Residuals for Example 4.1

Observation	$e_i = y_i - \hat{y}_i$	$d_i = e_i / \sqrt{MS_{Res}}$	$r_i = e_i / \sqrt{MS_{Res}(1 - h_{ii})}$	h_{ii}	$e_{(i)} = e_i / (1 - h_{ii})$	$t_i = e_i / \sqrt{S_{(i)}^2(1 - h_{ii})}$	$[e_i / (1 - h_{ii})]^2$
Number, i	(1)	(2)	(3)	(4)	(5)	(6)	(7)
1	-5.0281	-1.5426	-1.6277	0.10180	-5.5980	-1.6956	31.3373
2	1.1464	0.3517	0.349	0.07070	1.2336	0.3575	1.5218
3	-0.0498	-0.0153	-0.0161	0.09874	-0.0557	-0.0157	0.0031
4	4.9244	1.5108	1.5798	0.05838	5.2297	1.6392	27.3499
5	-0.4444	-0.1363	-0.1418	0.07501	-0.4804	-0.1386	0.2308
6	-0.2896	-0.0888	-0.0908	0.04287	-0.3025	-0.0887	0.0915
7	0.8446	0.2501	0.2704	0.08180	0.9198	0.2646	0.8461
8	1.1566	0.3548	0.3667	0.06373	1.2353	0.3594	1.5260
9	7.4197	2.2763	3.2138	0.49829	14.7888	4.3108	218.7093
10	2.3764	0.7291	0.8133	0.19630	2.9568	0.8068	8.728
11	2.2375	0.6865	0.7181	0.08613	2.4484	0.7099	5.9946
12	-0.5930	-0.1819	-0.1932	0.11366	-0.6690	-0.1890	0.4476
13	1.0270	0.3151	0.3252	0.06113	1.0938	0.3185	1.1965
14	1.0675	0.3275	0.3411	0.07824	1.1581	0.3342	1.3412
15	0.6712	0.2059	0.2103	0.04111	0.7000	0.2057	0.4900
16	-0.6629	-0.2034	-0.2227	0.16594	-0.7948	-0.2178	0.6317
17	0.4364	0.1339	0.1381	0.05943	0.4640	0.1349	0.2153
18	3.4486	1.0580	1.1130	0.09626	3.8159	1.1193	14.5612
19	1.7932	0.5502	0.5787	0.09645	1.9846	0.5698	3.9387
20	-5.7880	-1.7758	-1.8736	0.10169	-6.4432	-1.9967	41.5150
21	-2.6142	-0.8020	-0.8779	0.16528	-3.1318	-0.8731	9.8084
22	-3.6865	-1.1310	-1.4500	0.39158	-6.0591	-1.4896	36.7131
23	-4.6076	-1.4136	-1.4437	0.04126	-4.8059	-1.4825	23.0966
24	-4.5728	-1.4029	-1.4961	0.12061	-5.2000	-1.5422	27.0397
25	-0.2126	-0.0652	-0.0675	0.06664	-0.2278	-0.0660	0.0519

PRESS = 457.4000

tive normal distribution will plot as a straight line. Let $t_{[1]} < t_{[2]} < \dots < t_{[n]}$ be the externally studentized residuals ranked in increasing order. If we plot $t_{[i]}$ against the cumulative probability $P_i = (i - \frac{1}{2})/n$, $i = 1, 2, \dots, n$, on the normal probability plot, the resulting points should lie approximately on a straight line. The straight line is usually determined visually, with emphasis on the central values (e.g., the 0.33 and 0.67 cumulative probability points) rather than the extremes. Substantial departures from a straight line indicate that the distribution is not normal. Sometimes normal probability plots are constructed by plotting the ranked residual $t_{[i]}$ against the “expected normal value” $\Phi^{-1}[(i - \frac{1}{2})/n]$, where Φ denotes the standard normal cumulative distribution. This follows from the fact that $E(t_{[i]}) \approx \Phi^{-1}[(i - \frac{1}{2})/n]$.

Figure 4.3a displays an “idealized” normal probability plot. Notice that the points lie approximately along a straight line. Panels *b–e* present other typical problems. Panel *b* shows a sharp upward and downward curve at both extremes, indicating that the tails of this distribution are too light for it to be considered normal. Conversely, panel *c* shows flattening at the extremes, which is a pattern typical of samples from a distribution with heavier tails than the normal. Panels *d* and *e* exhibit patterns associated with positive and negative skew, respectively.[†]

Because samples taken from a normal distribution will not plot exactly as a straight line, some experience is required to interpret normal probability plots. Daniel and Wood [1980] present normal probability plots for sample sizes 8–384. Study of these plots is helpful in acquiring a feel for how much deviation from the

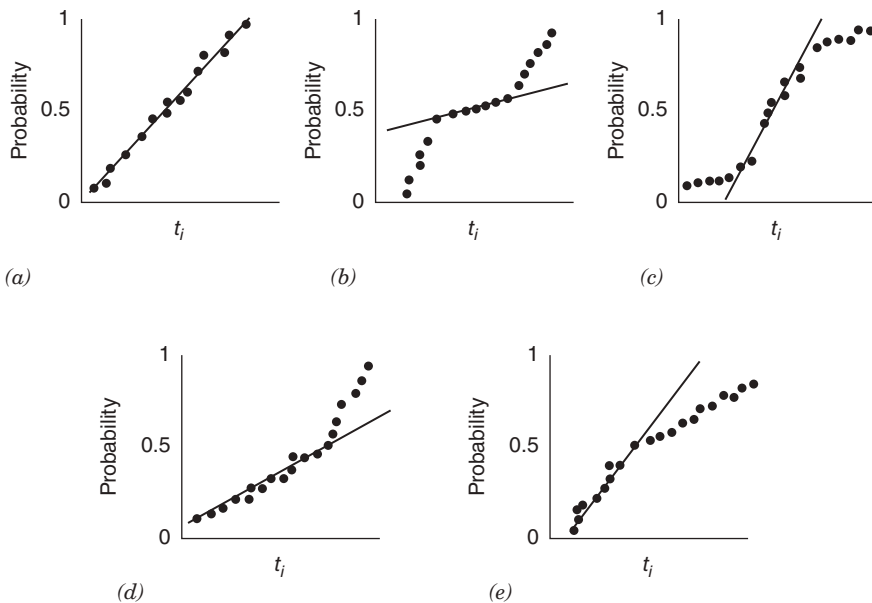

Figure 4.3 Normal probability plots: (a) ideal; (b) light-tailed distribution; (c) heavy-tailed distribution; (d) positive skew; (e) negative skew.

[†]These interpretations assume that the ranked residuals are plotted on the horizontal axis. If the residuals are plotted on the vertical axis, as some computer systems do, the interpretation is reversed.

straight line is acceptable. Small sample sizes ($n \leq 16$) often produce normal probability plots that deviate substantially from linearity. For larger sample sizes ($n \geq 32$) the plots are much better behaved. Usually about 20 points are required to produce normal probability plots that are stable enough to be easily interpreted.

Andrews [1979] and Gnanadesikan [1977] note that normal probability plots often exhibit no unusual behavior even if the errors ε_i are not normally distributed. This problem occurs because the residuals are not a simple random sample; they are the remnants of a parameter estimation process. The residuals are actually linear combinations of the model errors (the ε_i). Thus, fitting the parameters tends to destroy the evidence of nonnormality in the residuals, and consequently we cannot always rely on the normal probability plot to detect departures from normality.

A common defect that shows up on the normal probability plot is the occurrence of one or two large residuals. Sometimes this is an indication that the corresponding observations are **outliers**. For additional discussion of outliers, refer to Section 4.4.

Example 4.2 The Delivery Time Data

Figure 4.4 presents a normal probability plot of the externally studentized residuals from the regression model for the delivery time data from Example 3.1. The residuals are shown in columns 1 and 2 of Table 4.1.

The residuals do not lie exactly along a straight line, indicating that there may be some problems with the normality assumption, or that there may be one or more outliers in the data. From Example 4.1, we know that the studentized residual for observation 9 is moderately large ($r_9 = 3.2138$), as is the R -student residual ($t_9 = 4.3108$). However, there is no indication of a severe problem in the delivery time data. ■

Plot of Residuals against the Fitted Values \hat{y}_i A plot of the (preferably the externally studentized residuals, t_i) versus the corresponding fitted values \hat{y}_i is useful for detecting several common types of model inadequacies.[†] If this plot resembles Figure 4.5a, which indicates that the residuals can be contained in a horizontal band, then there are no obvious model defects. Plots of t_i versus \hat{y}_i that resemble any of the patterns in panels *b–d* are symptomatic of model deficiencies.

The patterns in panels *b* and *c* indicate that the variance of the errors is not constant. The **outward-opening funnel pattern** in panel *b* implies that the variance is an increasing function of y [an inward-opening funnel is also possible, indicating that $\text{Var}(\varepsilon)$ increases as y decreases]. The double-bow pattern in panel *c* often occurs when y is a proportion between zero and 1. The variance of a binomial proportion near 0.5 is greater than one near zero or 1. The usual approach for dealing with inequality of variance is to apply a suitable **transformation** to either the regressor or the response variable (see Sections 5.2 and 5.3) or to use the method of weighted least squares (Section 5.5). In practice, transformations on the response are generally employed to stabilize variance.

A curved plot such as in panel *d* indicates **nonlinearity**. This could mean that other regressor variables are needed in the model. For example, a squared term may

[†]The residuals should be plotted versus the fitted values \hat{y}_i and not the observed values y_i because the e_i and the \hat{y}_i are uncorrelated while the e_i and the y_i are usually correlated. The proof of this statement in Appendix C.10.

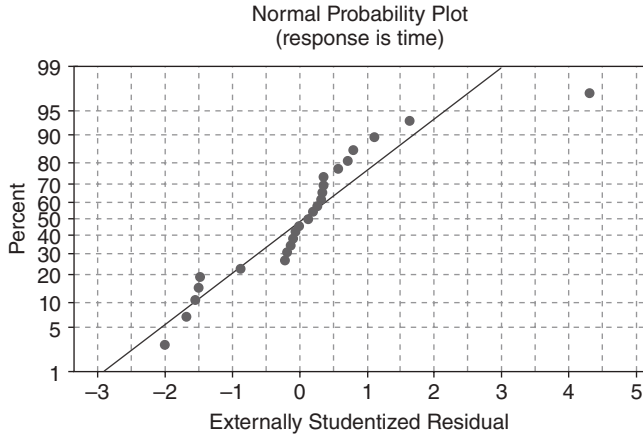

Figure 4.4 Normal probability plot of the externally studentized residuals for the delivery time data.

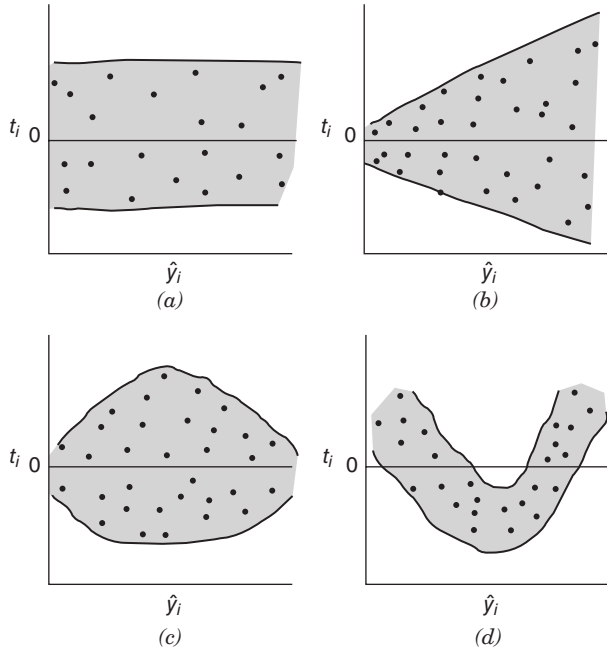

Figure 4.5 Patterns for residual plots: (a) satisfactory; (b) funnel; (c) double bow; (d) nonlinear.

be necessary. Transformations on the regressor and/or the response variable may also be helpful in these cases.

A plot of the residuals against \hat{y}_i may also reveal one or more unusually large residuals. These points are, of course, potential outliers. Large residuals that occur at the extreme \hat{y}_i values could also indicate that either the variance is not constant or the true relationship between y and x is not linear. These possibilities should be investigated before the points are considered outliers.

Example 4.3 The Delivery Time Data

Figure 4.6 presents the plot of the externally studentized residuals versus the fitted values of delivery time. The plot does not exhibit any strong unusual pattern, although the large residual t_9 shows up clearly. There does seem to be a slight tendency for the model to underpredict short delivery times and overpredict long delivery times. ■

Plot of Residuals against the Regressor Plotting the residuals against the corresponding values of each regressor variable can also be helpful. These plots often exhibit patterns such as those in Figure 4.5, except that the horizontal scale is x_{ij} for the j th regressor rather than \hat{y}_i . Once again an impression of a horizontal band containing the residuals is desirable. The funnel and double-bow patterns in panels *b* and *c* indicate nonconstant variance. The curved band in panel *d* or a nonlinear pattern in general implies that the assumed relationship between y and the regressor x_j is not correct. Thus, either higher order terms in x_j (such as x_j^2) or a transformation should be considered.

In the simple linear regressor case, it is not necessary to plot residuals versus both \hat{y}_i and the regressor variable. The reason is that the fitted values \hat{y}_i are linear combinations of the regressor values x_i , so the plots would only differ in the scale for the abscissa.

Example 4.4 The Delivery Time Data

Figure 4.7 presents the plots of the externally studentized residuals t_i from the delivery time problem in Example 3.1 versus both regressors. Panel *a* plots residuals versus cases and panel *b* plots residuals versus distance. Neither of these plots reveals any clear indication of a problem with either misspecification of the regressor (implying the need for either a transformation on the regressor or higher order

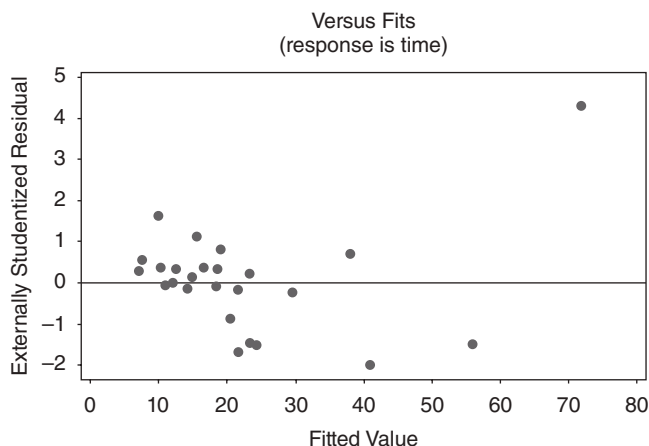

Figure 4.6 Plot of externally studentized residuals versus predicted for the delivery time data.

terms in cases and/or distance) or inequality of variance, although the moderately large residual associated with point 9 is apparent on both plots.

It is also helpful to plot residuals against regressor variables that are **not currently in the model** but which could potentially be included. Any structure in the plot of residuals versus an omitted variable indicates that incorporation of that variable could improve the model.

Plotting residuals versus a regressor is not always the most effective way to reveal whether a curvature effect (or a transformation) is required for that variable in the model. In Section 4.2.4 we describe two additional residual plots that are more effective in investigating the relationship between the response variable and the regressors. ■

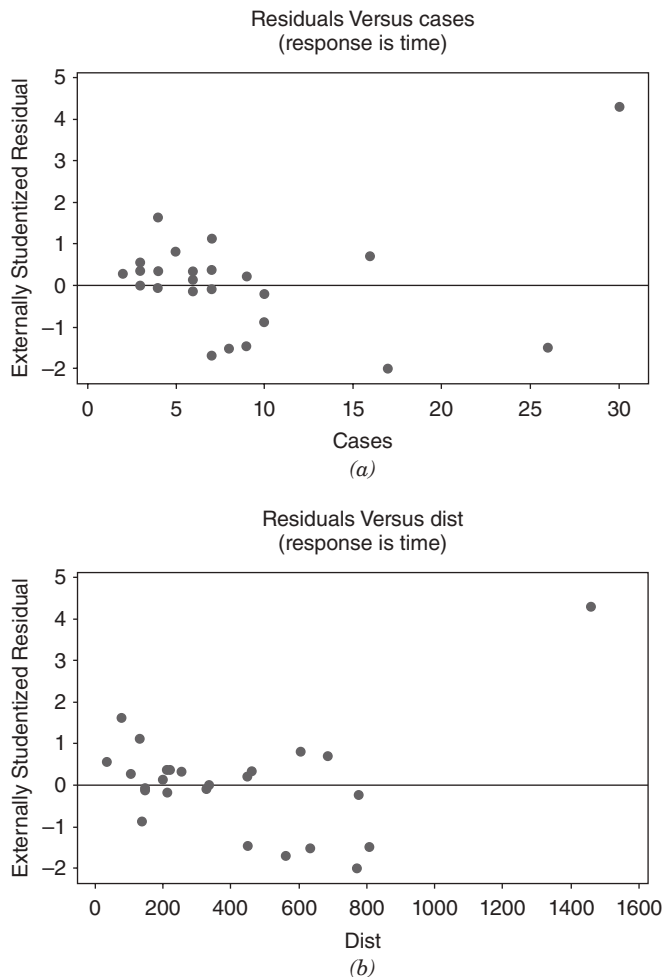

Figure 4.7 Plot of externally studentized residuals versus the regressors for the delivery time data: (a) residuals versus cases; (b) residuals versus distance.

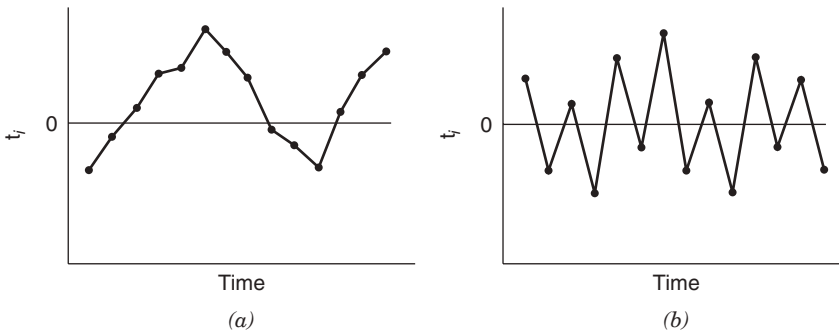

Figure 4.8 Prototype residual plots against time displaying autocorrelation in the errors: (a) positive autocorrelation; (b) negative autocorrelation.

Plot of Residuals in Time Sequence If the time sequence in which the data were collected is known, it is a good idea to plot the residuals against time order. Ideally, this plot will resemble Figure 4.5a; that is, a horizontal band will enclose all of the residuals, and the residuals will fluctuate in a more or less random fashion within this band. However, if this plot resembles the patterns in Figures 4.5b–d, this may indicate that the variance is changing with time or that linear or quadratic terms in time should be added to the model.

The time sequence plot of residuals may indicate that the errors at one time period are correlated with those at other time periods. The correlation between model errors at different time periods is called **autocorrelation**. A plot such as Figure 4.8a indicates positive autocorrelation, while Figure 4.8b is typical of negative autocorrelation. The presence of autocorrelation is a potentially serious violation of the basic regression assumptions. More discussion about methods for detecting autocorrelation and remedial measures are discussed in Chapter 14.

4.2.4 Partial Regression and Partial Residual Plots

We noted in Section 4.2.3 that a plot of residuals versus a regressor variable is useful in determining whether a curvature effect for that regressor is needed in the model. A limitation of these plots is that they may not completely show the correct or complete marginal effect of a regressor, given the other regressors in the model. A **partial regression plot** is a variation of the plot of residuals versus the predictor that is an enhanced way to study the marginal relationship of a regressor given the other variables that are in the model. This plot can be very useful in evaluating whether we have specified the relationship between the response and the regressor variables correctly. Sometimes the partial residual plot is called the **added-variable plot** or the **adjusted-variable plot**. Partial regression plots can also be used to provide information about the marginal usefulness of a variable that is not currently in the model.

Partial regression plots consider the marginal role of the regressor x_j given other regressors that are already in the model. In this plot, the response variable y and the regressor x_j are both regressed against the other regressors in the model and the residuals obtained for each regression. The plot of these residuals against each other provides information about the nature of the marginal relationship for regressor x_j under consideration.

To illustrate, suppose we are considering a first-order multiple regression model with two regressors variables, that is, $y = \beta_0 + \beta_1 x_1 + \beta_2 x_2 + \varepsilon$. We are concerned about the nature of the marginal relationship for regressor x_1 —in other words, is the relationship between y and x_1 correctly specified? First we would regress y on x_2 and obtain the fitted values and residuals:

$$\begin{aligned}\hat{y}_i(x_2) &= \hat{\theta}_0 + \hat{\theta}_1 x_{i2} \\ e_i(y|x_2) &= y_i - \hat{y}_i(x_2), \quad i = 1, 2, \dots, n\end{aligned}\quad (4.14)$$

Now regress x_1 on x_2 and calculate the residuals:

$$\begin{aligned}\hat{x}_{i1}(x_2) &= \hat{\alpha}_0 + \hat{\alpha}_1 x_{i2} \\ e_i(x_1|x_2) &= x_{i1} - \hat{x}_{i1}(x_2), \quad i = 1, 2, \dots, n\end{aligned}\quad (4.15)$$

The partial regression plot for regressor variable x_1 is obtained by plotting the y residuals $e_i(y|x_2)$ against the x_1 residuals $e_i(x_1|x_2)$. If the regressor x_1 enters the model linearly, then the partial regression plot should show a linear relationship, that is, the partial residuals will fall along a straight line with a nonzero slope. The slope of this line will be the regression coefficient of x_1 in the multiple linear regression model. If the partial regression plot shows a curvilinear band, then higher order terms in x_1 or a transformation (such as replacing x_1 with $1/x_1$) may be helpful. When x_1 is a **candidate** variable being considered for inclusion in the model, a horizontal band on the partial regression plot indicates that there is no additional useful information in x_1 for predicting y .

Example 4.5 The Delivery Time Data

Figure 4.9 presents the partial regression plots for the delivery time data, with the plot for x_1 shown in Figure 4.9a and the plot for x_2 shown in Figure 4.9b. The linear relationship between both cases and distance is clearly evident in both of these plots, although, once again, observation 9 falls somewhat off the straight line that apparently well-describes the rest of the data. This is another indication that point 9 bears further investigation. ■

Some Comments on Partial Regression Plots

1. Partial regression plots need to be used with caution as they only suggest **possible** relationships between the regressor and the response. These plots may not give information about the proper form of the relationship if several variables already in the model are incorrectly specified. It will usually be necessary to investigate several alternate forms for the relationship between the regressor and y or several transformations. Residual plots for these subsequent models should be examined to identify the best relationship or transformation.
2. Partial regression plots will not, in general, detect **interaction** effects among the regressors.

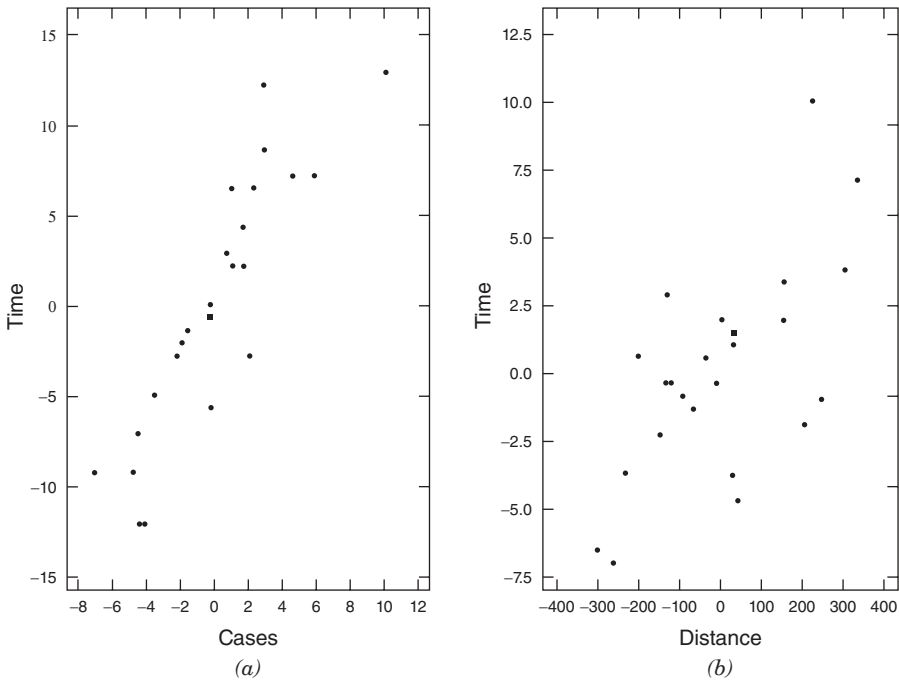

Figure 4.9 Partial regression plots for the delivery time data.

3. The presence of strong multicollinearity (refer to Section 3.9 and Chapter 9) can cause partial regression plots to give incorrect information about the relationship between the response and the regressor variables.
4. It is fairly easy to give a general development of the partial regression plotting concept that shows clearly why the slope of the plot should be the regression coefficient for the variable of interest, say x_j .

The partial regression plot is a plot of residuals from which the linear dependence of y on all regressors other than x_j has been removed against regressor x_j with its linear dependence on other regressors removed. In matrix form, we may write these quantities as $\mathbf{e}[y|\mathbf{X}_{(j)}]$ and $\mathbf{e}[x_j|\mathbf{X}_{(j)}]$, respectively, where $\mathbf{X}_{(j)}$ is the original \mathbf{X} matrix with the j th regressor (x_j) removed. To show how these quantities are defined, consider the model

$$\mathbf{y} = \mathbf{X}\boldsymbol{\beta} + \boldsymbol{\varepsilon} = \mathbf{X}_{(j)}\boldsymbol{\beta} + \beta_j\mathbf{x}_j + \boldsymbol{\varepsilon} \quad (4.16)$$

Premultiply Eq. (4.16) by $\mathbf{I} - \mathbf{H}_{(j)}$ to give

$$(\mathbf{I} - \mathbf{H}_{(j)})\mathbf{y} = (\mathbf{I} - \mathbf{H}_{(j)})\mathbf{X}_{(j)}\boldsymbol{\beta} + \beta_j(\mathbf{I} - \mathbf{H}_{(j)})\mathbf{x}_j + (\mathbf{I} - \mathbf{H}_{(j)})\boldsymbol{\varepsilon}$$

and note that $(\mathbf{I} - \mathbf{H}_{(j)})\mathbf{X}_{(j)} = \mathbf{0}$, so that

$$(\mathbf{I} - \mathbf{H}_{(j)})\mathbf{y} = \beta_j(\mathbf{I} - \mathbf{H}_{(j)})\mathbf{x}_j + (\mathbf{I} - \mathbf{H}_{(j)})\boldsymbol{\varepsilon}$$

or

$$\mathbf{e}[\mathbf{y} | \mathbf{X}_{(j)}] = \beta_j \mathbf{e}[\mathbf{x}_j | \mathbf{X}_{(j)}] + \boldsymbol{\varepsilon}^*$$

where $\boldsymbol{\varepsilon}^* = (\mathbf{I} - \mathbf{H}_{(j)})\boldsymbol{\varepsilon}$. This suggests that a partial regression plot should have slope β_j . Thus, if x_j enters the regression in a linear fashion, the partial regression plot should show a linear relationship passing through the origin. Many computer programs (such as SAS and Minitab) will generate partial regression plots.

Partial Residual Plots A residual plot closely related to the partial regression plot is the **partial residual plot**. It is also designed to show the relationship between the response variable and the regressors. Suppose that the model contains the regressors x_1, x_2, \dots, x_k . The **partial residuals** for regressor x_j are defined as

$$e_i^*(y|x_j) = e_i + \hat{\beta}_j x_{ij}, \quad i = 1, 2, \dots, n$$

where the e_i are the residuals from the model with all k regressors included. When the partial residuals are plotted against x_{ij} , the resulting display has slope $\hat{\beta}_j$, the regression coefficient associated with x_j in the model. The interpretation of the partial residual plot is very similar to that of the partial regression plot. See Larsen and McCearry [1972], Daniel and Wood [1980], Wood [1973], Mallows [1986], Mansfield and Conerly [1987], and Cook [1993] for more details and examples.

4.2.5 Using Minitab®, SAS, and R for Residual Analysis

It is easy to generate the residual plots in Minitab. Select the “graphs” box. Once it is opened, select the “deleted” option to get the studentized residuals. You then select the residual plots you want.

Table 4.2 gives the SAS source code for SAS version 9 to do residual analysis for the delivery time data. The partial option provides the partial regression plots. A common complaint about SAS is the quality of many of the plots generated by its procedures. These partial regression plots are prime examples. Version 9, however, upgrades some of the more important graphics plots for PROC REG. The first plot statement generates the studentized residuals versus predicted values, the studentized residuals versus the regressors, and the studentized residuals by time plots (assuming that the order in which the data are given is the actual time order). The second plot statement gives the normal probability plot of the studentized residuals.

As we noted, over the years the basic plots generated by SAS have been improved. Table 4.3 gives appropriate source code for earlier versions of SAS that produce “nice” residual plots. This code is important when we discuss plots from other SAS procedures that still do not generate nice plots. Basically this code uses the OUTPUT command to create a new data set that includes all of the previous delivery information plus the predicted values and the studentized residuals. It then uses the SAS-GRAPH features of SAS to generate the residual plots. The code uses PROC CAPABILITY to generate the normal probability plot. Unfortunately, PROC CAPABILITY by default produces a lot of noninteresting information in the output file.

TABLE 4.2 SAS Code for Residual Analysis of Delivery Time Data

```

date delivery;
input time cases distance;
cards;
16.68 7 560
11.50 3 220
12.03 3 340
14.88 4 80
13.75 6 150
18.11 7 330
 8.00 2 110
17.83 7 210
79.24 30 1460
21.50 5 605
40.33 16 688
21.00 10 215
13.50 4 255
19.75 6 462
24.00 9 448
29.00 10 776
15.35 6 200
19.00 7 132
 9.50 3 36
35.10 17 770
17.90 10 140
52.32 26 810
18.75 9 450
19.83 8 635
10.75 4 150
proc reg;
  model time = cases distance / partial;
  plot rstudent.*(predicted. cases distance obs.);
  plot npp.*rstudent.;
run;

```

We next illustrate how to use R to create appropriate residual plots. Once again, consider the delivery data. The first step is to create a space delimited file named `delivery.txt`. The names of the columns should be `time`, `cases`, and `distance`.

The R code to do the basic analysis and to create the appropriate residual plots based on the externally studentized residuals is:

```

deliver <- read.table("delivery.txt",header=TRUE, sep=" ")
deliver.model <- lm(time~cases+distance, data=deliver)
summary(deliver.model)
yhat <- deliver.model$fit
t <- rstudent(deliver.model)
qqnorm(t)
plot(yhat,t)
plot(deliver$x1,t)
plot(deliver$x2,t)

```

TABLE 4.3 Older SAS Code for Residual Analysis of Delivery Time Data

```
date delivery;
input time cases distance;
cards;
16.68 7 560
11.50 3 220
12.03 3 340
14.88 4 80
13.75 6 150
18.11 7 330
 8.00 2 110
17.83 7 210
79.24 30 1460
21.50 5 605
40.33 16 688
21.00 10 215
13.50 4 255
19.75 6 462
24.00 9 448
29.00 10 776
15.35 6 200
19.00 7 132
 9.50 3 36
35.10 17 770
17.90 10 140
52.32 26 810
18.75 9 450
19.83 8 635
10.75 4 150
proc reg;
  model time = cases distance / partial;
  output out = delivery2 p = ptime rstudent= t;
run;
data delivery3;
  set delivery2;
  index = _n_;
proc gplot data = delivery3;
  plot t*ptime t*cases t*distance t*index;
run;
proc capability data = delivery3;
  var t;
  qqplot t;
run;
```

Generally, the graphics in R require a great deal of work in order to be of suitable quality. The commands

```
deliver2 <- cbind(deliver,yhat,t)
write.table(deliver2,"delivery_output.txt")
```

create a file “delivery_output.txt” which the user than can import into his/her favorite package for doing graphics.

4.2.6 Other Residual Plotting and Analysis Methods

In addition to the basic residual plots discussed in Sections 4.2.3 and 4.2.4, there are several others that are occasionally useful. For example, it may be very useful to construct a scatterplot of regressor x_i against regressor x_j . This plot may be useful in studying the relationship between regressor variables and the disposition of the data in x space. Consider the plot of x_i versus x_j in Figure 4.10. This display indicates that x_i and x_j are highly positively correlated. Consequently, it may not be necessary to include both regressors in the model. If two or more regressors are highly correlated, it is possible that multicollinearity is present in the data. As observed in Chapter 3 (Section 3.10), multicollinearity can seriously disturb the least-squares fit and in some situations render the regression model almost useless. Plots of x_i versus x_j may also be useful in discovering points that are remote from the rest of the data and that potentially influence key model properties. Anscombe [1973] presents several other types of plots between regressors. Cook and Weisberg [1994] give a very modern treatment of regression graphics, including many advanced techniques not considered in this book.

Figure 4.11 is a scatterplot of x_1 (cases) versus x_2 (distance) for delivery time data from Example 3.1 (Table 3.2). Comparing Figure 4.11 with Figure 4.10, we see that cases and distance are positively correlated. In fact, the simple correlation between x_1 and x_2 is $r_{12} = 0.82$. While highly correlated regressors can cause a number of serious problems in regression, there is no strong indication in this example that

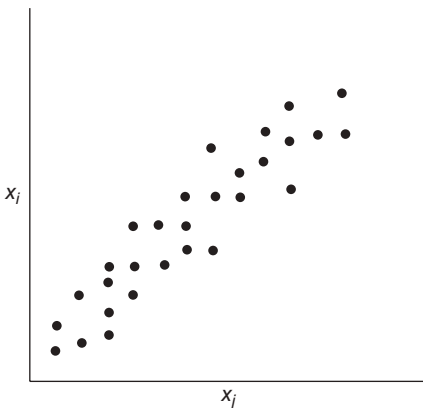

Figure 4.10 Plot of x_i versus x_j .

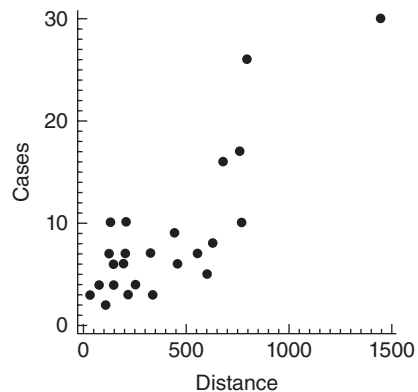

Figure 4.11 Plot of regressor x_1 (cases) versus regressor x_2 (distance for the delivery time data in Table 3.2.

any problems have occurred. The scatterplot clearly reveals that observation 9 is unusual with respect to both cases and distance ($x_1 = 30$, $x_2 = 1460$); in fact, it is rather remote in x space from the rest of the data. Observation 22 ($x_1 = 26$, $x_2 = 810$) is also quite far from the rest of the data. Points remote in x space can potentially control some of the properties of the regression model. Other formal methods for studying this are discussed in Chapter 6.

The **problem situation** often suggests other types of residual plots. For example, consider the delivery time data in Example 3.1. The 25 observations in Table 3.2 were collected on truck routes in four different cities. Observations 1–7 were collected in San Diego, observations 8–17 in Boston, observations 18–23 in Austin, and observations 24 and 25 in Minneapolis. We might suspect that there is a difference in delivery operations from city to city due to such factors as different types of equipment, different levels of crew training and experience, or motivational factors influenced by management policies. These factors could result in a “site” effect that is not incorporated in the present equation. To investigate this, we plot the residuals by site in Figure 4.12. We see from this plot that there is some imbalance in the distribution of positive and negative residuals at each site. Specifically, there is an apparent tendency for the model to overpredict delivery times in Austin and underpredict delivery times in Boston. This could happen because of the site-dependent factors mentioned above or because one or more important regressors have been omitted from the model.

Statistical Tests on Residuals We may apply statistical tests to the residuals to obtain quantitative measures of some of the model inadequacies discussed above. For example, see Anscombe [1961, 1967], Anscombe and Tukey [1963], Andrews [1971], Looney and Gullledge [1985], Levine [1960], and Cook and Weisberg [1983]. Several formal statistical testing procedures for residuals are discussed in Draper and Smith [1998] and Neter, Kutner, Nachtsheim, and Wasserman [1996].

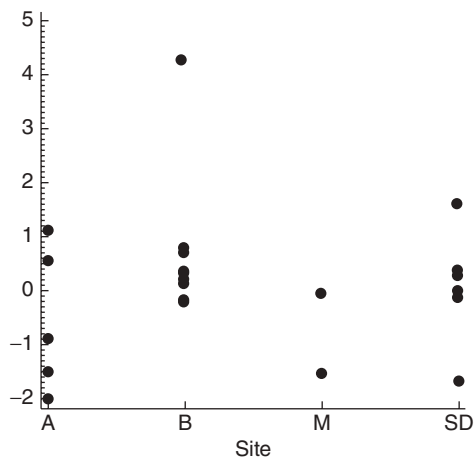

Figure 4.12 Plot of externally studentized residuals by site (city) for the delivery time data in Table 3.2.

In our experience, statistical tests on regression model residuals are not widely used. In most practical situations the residual plots are more informative than the corresponding tests. However, since residual plots do require skill and experience to interpret, the statistical tests may occasionally prove useful. For a good example of the use of statistical tests in conjunction with plots see Feder [1974].

4.3 PRESS STATISTIC

In Section 4.2.2 we defined the PRESS residuals as $e_{(i)} = y_i - \hat{y}_{(i)}$, where $\hat{y}_{(i)}$ is the predicted value of the i th observed response based on a model fit to the remaining $n - 1$ sample points. We noted that large PRESS residuals are potentially useful in identifying observations where the model does not fit the data well or observations for which the model is likely to provide poor future predictions.

Allen [1971, 1974] has suggested using the prediction error sum of squares (or the PRESS statistic), defined as the sum of the squared PRESS residuals, as a measure of model quality. The PRESS statistic is

$$\begin{aligned} \text{PRESS} &= \sum_{i=1}^n [y_i - \hat{y}_{(i)}]^2 \\ &= \sum_{i=1}^n \left(\frac{e_i}{1 - h_{ii}} \right)^2 \end{aligned} \quad (4.17)$$

PRESS is generally regarded as a measure of how well a regression model will perform in **predicting new data**. A model with a small value of PRESS is desired.

Example 4.6 The Delivery Time Data

Column 5 of Table 4.1 shows the calculations of the PRESS residuals for the delivery time data of Example 3.1. Column 7 of Table 4.1 contains the squared PRESS residuals, and the PRESS statistic is shown at the foot of this column. The value of $\text{PRESS} = 457.4000$ is nearly twice as large as the residual sum of squares for this model, $SS_{\text{Res}} = 233.7260$. Notice that almost half of the PRESS statistic is contributed by point 9, a relatively remote point in x space with a moderately large residual. This indicates that the model will not likely predict new observations with large case volumes and long distances particularly well. ■

R^2 for Prediction Based on PRESS The PRESS statistic can be used to compute an R^2 -like statistic for prediction, say

$$R^2_{\text{prediction}} = 1 - \frac{\text{PRESS}}{SS_T} \quad (4.18)$$

This statistic gives some indication of the predictive capability of the regression model. For the soft drink delivery time model we find

$$\begin{aligned}
 R_{\text{prediction}}^2 &= 1 - \frac{\text{PRESS}}{SS_T} \\
 &= 1 - \frac{457.4000}{5784.5426} \\
 &= 0.9209
 \end{aligned}$$

Therefore, we could expect this model to “explain” about 92.09% of the variability in predicting new observations, as compared to the approximately 95.96% of the variability in the original data explained by the least-squares fit. The predictive capability of the model seems satisfactory, overall. However, recall that the individual PRESS residuals indicated that observations that are similar to point 9 may not be predicted well.

Using PRESS to Compare Models One very important use of the PRESS statistic is in comparing regression models. Generally, a model with a small value of PRESS is preferable to one where PRESS is large. For example, when we added $x_2 = \text{distance to the regression model}$ for the delivery time data containing $x_1 = \text{cases}$, the value of PRESS decreased from 733.55 to 457.40. This is an indication that the two-regressor model is likely to be a better predictor than the model containing only $x_1 = \text{cases}$.

4.4 DETECTION AND TREATMENT OF OUTLIERS

An outlier is an extreme observation; one that is considerably different from the majority of the data. Residuals that are considerably larger in absolute value than the others, say three or four standard deviations from the mean, indicate potential y space outliers. Outliers are data points that are not typical of the rest of the data. Depending on their location in x space, outliers can have moderate to severe effects on the regression model (e.g., see Figures 2.6–2.8). Residual plots against \hat{y}_i and the normal probability plot are helpful in identifying outliers. Examining **scaled residuals**, such as the studentized and R -student residuals, is an excellent way to identify potential outliers. An excellent general treatment of the outlier problems is in Barnett and Lewis [1994]. Also see Myers [1990] for a good discussion.

Outliers should be carefully investigated to see if a reason for their unusual behavior can be found. Sometimes outliers are “bad” values, occurring as a result of unusual but explainable events. Examples include faulty measurement or analysis, incorrect recording of data, and failure of a measuring instrument. If this is the case, then the outlier should be corrected (if possible) or deleted from the data set. Clearly discarding bad values is desirable because least squares pulls the fitted equation toward the outlier as it minimizes the residual sum of squares. However, we emphasize that there should be strong nonstatistical evidence that the outlier is a bad value before it is discarded.

Sometimes we find that the outlier is an unusual but perfectly plausible observation. Deleting these points to “improve the fit of the equation” can be dangerous,

as it can give the user a false sense of precision in estimation or prediction. Occasionally we find that the outlier is more important than the rest of the data because it may control many key model properties. Outliers may also point out inadequacies in the model, such as failure to fit the data well in a certain region of x space. If the outlier is a point of particularly desirable response (e.g., low cost, high yield), knowledge of the regressor values when that response was observed may be extremely valuable. Identification and follow-up analyses of outliers often result in process improvement or new knowledge concerning factors whose effect on the response was previously unknown.

Various statistical tests have been proposed for detecting and rejecting outliers. For example, see Barnett and Lewis [1994]. Stefansky [1971, 1972] has proposed an approximate test for identifying outliers based on the maximum normed residual $|e_i|/\sqrt{\sum_{i=1}^n e_i^2}$ that is particularly easy to apply. Examples of this test and other related references are in Cook and Prescott [1981], Daniel [1976], and Williams [1973]. See also Appendix C.9. While these tests may be useful for identifying outliers, they should not be interpreted to imply that the points so discovered should be automatically rejected. As we have noted, these points may be important clues containing valuable information.

The effect of outliers on the regression model may be easily checked by dropping these points and refitting the regression equation. We may find that the values of the regression coefficients or the summary statistics such as the t or F statistic, R^2 , and the residual mean square may be very sensitive to the outliers. Situations in which a relatively small percentage of the data has a significant impact on the model may not be acceptable to the user of the regression equation. Generally we are happier about assuming that a regression equation is valid if it is not overly sensitive to a few observations. We would like the regression relationship to be embedded in all of the observations and not merely an artifice of a few points.

Example 4.7 The Rocket Propellant Data

Figure 4.13 presents the normal probability plot of the externally studentized residuals and the plot of the externally studentized residuals versus the predicted \hat{y}_i for the rocket propellant data introduced in Example 2.1. We note that there are two large negative residuals that lie quite far from the rest (observations 5 and 6 in Table 2.1). These points are potential outliers. These two points tend to give the normal probability plot the appearance of one for skewed data. Note that observation 5 occurs at a relatively low value of age (5.5 weeks) and observation 6 occurs at a relatively high value of age (19 weeks). Thus, these two points are widely separated in x space and occur near the extreme values of x , and they may be influential in determining model properties. Although neither residual is excessively large, the overall impression from the residual plots (Figure 4.13) is that these two observations are distinctly from the others.

To investigate the influence of these two points on the model, a new regression equation is obtained with observations 5 and 6 deleted. A comparison of the summary statistics from the two models is given below.

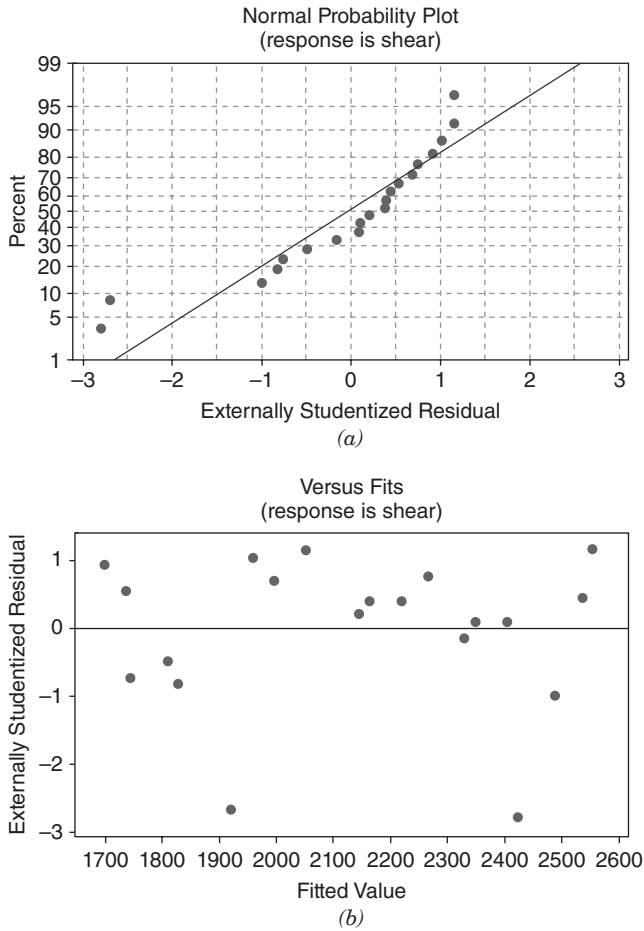

Figure 4.13 Externally studentized residual plots for the rocket propellant data: (a) the normal probability plot; (b) residuals versus predicted \hat{y}_i .

	Observations 5 and 6 IN	Observations 5 and 6 OUT
$\hat{\beta}_0$	2627.82	2658.97
$\hat{\beta}_1$	-37.15	-37.69
R^2	0.9018	0.9578
MS_{Res}	9244.59	3964.63
$se(\hat{\beta}_1)$	2.89	1.98

Deleting points 5 and 6 has almost no effect on the estimates of the regression coefficients. There has, however, been a dramatic reduction in the residual mean square, a moderate increase in R^2 , and approximately a one-third reduction in the standard error of $\hat{\beta}_1$.

Since the estimates of the parameters have not changed dramatically, we conclude that points 5 and 6 are not overly influential. They lie somewhat off the line passing through the other 18 points, but they do not control the slope and intercept. However, these two residuals make up approximately 56% of the residual sum of squares. Thus, if these points are truly bad values and should be deleted, the precision of the parameter estimates would be improved and the widths of confidence and prediction intervals could be substantially decreased.

Figure 4.14 shows the normal probability plot of the externally studentized residuals and the plot of the externally studentized residuals versus \hat{y}_i for the model with points 5 and 6 deleted. These plots do not indicate any serious departures from assumptions.

Further examination of points 5 and 6 fails to reveal any reason for the unusually low propellant shear strengths obtained. Therefore, we should not discard these two points. However, we feel relatively confident that including them does not seriously limit the use of the model. ■

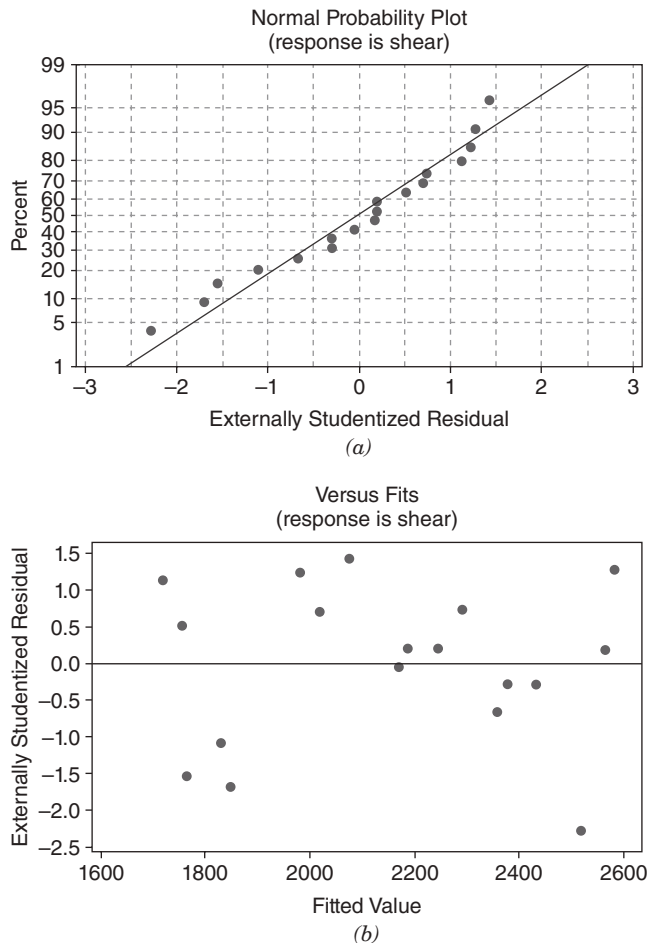

Figure 4.14 Residual plots for the rocket propellant data with observations 5 and 6 removed: (a) the normal probability plot; (b) residuals versus predicted \hat{y}_i .

4.5 LACK OF FIT OF THE REGRESSION MODEL

A famous quote attributed to George Box is “All models are wrong; some models are useful.” This comment goes to heart of why tests for lack-of-fit are important. In basic English, lack-of-fit is “the terms that we could have fit to the model but chose not to fit.” For example, only two distinct points are required to fit a straight line. If we have three distinct points, then we could fit a parabola (a second-order model). If we choose to fit only the straight line, then we note that in general the straight line does not go through all three points. We typically assume that this phenomenon is due to error. On the other hand, the true underlying mechanism could really be quadratic. In the process, what we claim to be random error is actually a systematic departure as the result of not fitting enough terms. In the simple linear regression context, if we have n distinct data points, we can always fit a polynomial of order up to $n - 1$. When we choose to fit a straight line, we give up $n - 2$ degrees of freedom to estimate the error term when we could have chosen to fit these other higher-order terms.

4.5.1 A Formal Test for Lack of Fit

The formal statistical test for the lack of fit of a regression model assumes that the normality, independence, and constant-variance requirements are met and that only the first-order or straight-line character of the relationship is in doubt. For example, consider the data in Figure 4.15. There is some indication that the straight-line fit is not very satisfactory. Perhaps, a quadratic term (x^2) should be added, or perhaps another regressor should be added. It would be helpful to have a test procedure to determine if systematic lack of fit is present.

The lack-of-fit test requires that we have replicate observations on the response y for at least one level of x . We emphasize that these should be true replications, not just duplicate readings or measurements of y . For example, suppose that y is product viscosity and x is temperature. True replication consists of running n_i separate experiments at $x = x_i$ and observing viscosity, not just running a single

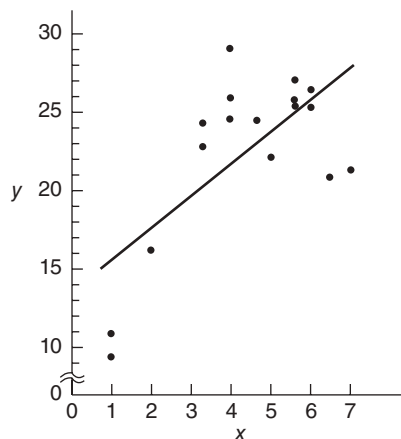

Figure 4.15 Data illustrating lack of fit of the straight-line model.

experiment at x_i and measuring viscosity n_i times. The readings obtained from the latter procedure provide information only on the variability of the method of measuring viscosity. The error variance σ^2 includes this measurement error and the variability associated with reaching and maintaining the same temperature level in different experiments. These replicated observations are used to obtain a **model-independent estimate** of σ^2 .

Suppose that we have n_i observations on the response at the i th level of the regressor x_i , $i = 1, 2, \dots, m$. Let y_{ij} denote the j th observation on the response at x_i , $i = 1, 2, \dots, m$ and $j = 1, 2, \dots, n_i$. There are $n = \sum_{i=1}^m n_i$ total observations. The test procedure involves partitioning the residual sum of squares into two components, say

$$SS_{\text{Res}} = SS_{\text{PE}} + SS_{\text{LOF}}$$

where SS_{PE} is the sum of squares due to **pure error** and SS_{LOF} is the sum of squares due to **lack of fit**.

To develop this partitioning of SS_{Res} , note that the (ij) th residual is

$$y_{ij} - \hat{y}_i = (y_{ij} - \bar{y}_i) + (\bar{y}_i - \hat{y}_i) \quad (4.19)$$

where \bar{y}_i is the average of the n_i observations at x_i . Squaring both sides of Eq. (4.19) and summing over i and j yields

$$\sum_{i=1}^m \sum_{j=1}^{n_i} (y_{ij} - \hat{y}_i)^2 = \sum_{i=1}^m \sum_{j=1}^{n_i} (y_{ij} - \bar{y}_i)^2 + \sum_{i=1}^m n_i (\bar{y}_i - \hat{y}_i)^2 \quad (4.20)$$

since the cross-product term equals zero.

The left-hand side of Eq. (4.20) is the usual residual sum of squares. The two components on the right-hand side measure pure error and lack of fit. We see that the pure-error sum of squares

$$SS_{\text{PE}} = \sum_{i=1}^m \sum_{j=1}^{n_i} (y_{ij} - \bar{y}_i)^2 \quad (4.21)$$

is obtained by computing the corrected sum of squares of the repeat observations at each level of x and then pooling over the m levels of x . If the assumption of constant variance is satisfied, this is a **model-independent measure of pure error** since only the variability of the y 's at each x level is used to compute SS_{PE} . Since there are $n_i - 1$ degrees of freedom for pure error at each level x_i , the total number of degrees of freedom associated with the pure-error sum of squares is

$$\sum_{i=1}^m (n_i - 1) = n - m \quad (4.22)$$

The sum of squares for lack of fit

$$SS_{\text{LOF}} = \sum_{i=1}^m n_i (\bar{y}_i - \hat{y}_i)^2 \quad (4.23)$$

is a weighted sum of squared deviations between the mean response \bar{y}_i at each x level and the corresponding fitted value. If the fitted values \hat{y}_i are close to the corresponding average responses \bar{y}_i , then there is a strong indication that the regression function is linear. If the \hat{y}_i deviate greatly from the \bar{y}_i , then it is likely that the regression function is not linear. There are $m - 2$ degrees of freedom associated with SS_{LOF} , since there are m levels of x and two degrees of freedom are lost because two parameters must be estimated to obtain the \bar{y}_i . Computationally we usually obtain SS_{LOF} by subtracting SS_{PE} from SS_{Res} .

The test statistic for lack of fit is

$$F_0 = \frac{SS_{\text{LOF}} / (m - 2)}{SS_{\text{PE}} / (n - m)} = \frac{MS_{\text{LOF}}}{MS_{\text{PE}}} \quad (4.24)$$

The expected value of MS_{PE} is σ^2 , and the expected value of MS_{LOF} is

$$E(MS_{\text{LOF}}) = \sigma^2 + \frac{\sum_{i=1}^m n_i [E(y_i) - \beta_0 - \beta_1 x_i]^2}{m - 2} \quad (4.25)$$

If the true regression function is linear, then $E(y_i) = \beta_0 + \beta_1 x_i$, and the second term of Eq. (4.25) is zero, resulting in $E(MS_{\text{LOF}}) = \sigma^2$. However, if the true regression function is not linear, then $E(y_i) \neq \beta_0 + \beta_1 x_i$, and $E(MS_{\text{LOF}}) > \sigma^2$. Furthermore, if the true regression function is linear, then the statistic F_0 follows the $F_{m-2, n-m}$ distribution. Therefore, to test for lack of fit, we would compute the test statistic F_0 and conclude that the regression function is not linear if $F_0 > F_{\alpha, m-2, n-m}$.

This test procedure may be easily introduced into the analysis of variance conducted for significance of regression. If we conclude that the regression function is not linear, then the tentative model must be abandoned and attempts made to find a more appropriate equation. Alternatively, if F_0 does not exceed $F_{\alpha, m-2, n-m}$, there is no strong evidence of lack of fit, and MS_{PE} and MS_{LOF} are often combined to estimate σ^2 .

Ideally, we find that the F ratio for lack of fit is not significant, and the hypothesis of significance of regression ($H_0: \beta_1 = 0$) is rejected. Unfortunately, this does not guarantee that the model will be satisfactory as a prediction equation. Unless the variation of the predicted values is large relative to the random error, the model is not estimated with sufficient precision to yield satisfactory predictions. That is, the model may have been fitted to the errors only. Some analytical work has been done on developing criteria for judging the adequacy of the regression model from a prediction point of view. See Box and Wetz [1973], Ellerton [1978], Gunst and Mason [1979], Hill, Judge, and Fomby [1978], and Suich and Derringer [1977]. The Box and Wetz work suggests that the observed F ratio must be at least four or five times the critical value from the F table if the regression model is to be useful as a predictor, that is, if the spread of predicted values is to be large relative to the noise.

A relatively simple measure of potential prediction performance is found by comparing the range of the fitted values \hat{y}_i (i.e., $\hat{y}_{\max} - \hat{y}_{\min}$) to their average standard error. It can be shown that, regardless of the form of the model, the average variance of the fitted values is

$$\overline{\text{Var}(\hat{y})} = \frac{1}{n} \sum_{i=1}^n \text{Var}(\hat{y}_i) = \frac{p\sigma^2}{n} \quad (4.26)$$

where p is the number of parameters in the model. In general, the model is not likely to be a satisfactory predictor unless the range of the fitted values \hat{y}_i is large relative to their average estimated standard error $\sqrt{(p\hat{\sigma}^2)/n}$, where $\hat{\sigma}^2$ is a model-independent estimate of the error variance.

Example 4.8 Testing for Lack of Fit

The data from Figure 4.15 are shown below:

x	1.0	1.0	2.0	3.3	3.3	4.0	4.0	4.0	4.7	5.0
y	10.84	9.30	16.35	22.88	24.35	24.56	25.86	29.16	24.59	22.25
x	5.6	5.6	5.6	6.0	6.0	6.5	6.9			
y	25.90	27.20	25.61	25.45	26.56	21.03	21.46			

The straight-line fit is $\hat{y} = 13.301 + 2.108x$, with $SS_T = 487.6126$, $SS_R = 234.7087$, and $SS_{\text{Res}} = 252.9039$. Note that there are 10 distinct levels of x , with repeat points at $x = 1.0$, $x = 3.3$, $x = 4.0$, $x = 5.6$, and $x = 6.0$. The pure-error sum of squares is computed using the repeat points as follows:

Level of x	$\sum_j (y_{ij} - \bar{y}_i)^2$	Degrees of Freedom
1.0	1.1858	1
3.3	1.0805	1
4.0	11.2467	2
5.6	1.4341	2
6.0	0.6161	1
Total	15.5632	7

The lack-of-fit sum of squares is found by subtraction as

$$\begin{aligned} SS_{\text{LOF}} &= SS_{\text{Res}} - SS_{\text{PE}} \\ &= 252.9039 - 15.5632 = 237.3407 \end{aligned}$$

with $m - 2 = 10 - 2 = 8$ degrees of freedom. The analysis of variance incorporating the lack-of-fit test is shown in Table 4.4. The lack-of-fit test statistic is $F_0 = 13.34$, and since the P value is very small, we reject the hypothesis that the tentative model adequately describes the data. ■

TABLE 4.4 Analysis of Variance for Example 4.8

Source of Variation	Sum of Squares	Degrees of Freedom	Mean Square	F_0	P Value
Regression	234.7087	1	234.7087		
Residual	252.9039	15	16.8603		
(Lack of fit)	237.3407	8	29.6676	13.34	0.0013
(Pure error)	15.5632	7	2.2233		
Total	487.6126	16			

Example 4.9 Testing for Lack of Fit in JMP

Some software packages will perform the lack of fit test automatically if there are replicate observations in the data. In the patient satisfaction data of Appendix Table B.17 there are replicate observations in the severity predictor (they occur at 30, 31, 38, 42, 28, and 50). Figure 4.16 is a portion of the JMP output that results from fitting a simple linear regression model to these data. The F -test for lack of fit in Equation 4.24 is shown in the output. The P -value is 0.0874, so there is some mild indication of lack of fit. Recall from Section 3.6 that when we added the second predictor (age) to this model the quality of the overall fit improved considerably. As this example illustrates, sometimes lack of fit is caused by missing regressors; it isn't always necessary to add higher-order terms to the model. ■

4.5.2 Estimation of Pure Error from Near Neighbors

In Section 4.5.1 we described a test for lack of fit for the linear regression model. The procedure involved partitioning the error or residual sum of squares into a component due to “pure” error and a component due to lack of fit:

$$SS_{\text{Res}} = SS_{\text{PE}} + SS_{\text{LOF}}$$

The pure-error sum of squares SS_{PE} is computed using responses at repeat observations at the same level of x . This is a **model-independent estimate** of σ^2 .

This general procedure can in principle be applied to any regression model. The calculation of SS_{PE} requires repeat observations on the response y at the same set of levels on the regressor variables x_1, x_2, \dots, x_k . That is, some of the **rows** of the \mathbf{X} matrix must be the same. However, repeat observations do not often occur in multiple regression, and the procedure described in Section 4.5.1 is not often useful.

Daniel and Wood [1980] and Joglekar, Schuenemeyer, and La Riccia [1989] have investigated methods for obtaining a model-independent estimate of error when there are no exact repeat points. These procedures search for points in x space that are **near neighbors**, that is, sets of observations that have been taken with nearly

Response Satisfaction Whole Model

Summary of Fit

RSquare	0.426596
RSquare Adj	0.401666
Root Mean Square Error	16.43242
Mean of Response	66.72
Observations (or Sum Wgts)	25

Analysis of Variance

Source	DF	Sum of Squares	Mean Square	F Ratio
Model	1	4620.482	4620.48	17.1114
Error	23	6210.558	270.02	Prob > F
C. Total	24	10831.040		0.0004*

Lack Of Fit

Source	DF	Sum of Squares	Mean Square	F Ratio
Lack Of Fit	16	5366.0584	335.379	2.7799
Pure Error	7	844.5000	120.643	Prob > F
Total Error	23	6210.5584		0.0874
				Max RSq
				0.9220

Parameter Estimates

Term	Estimate	Std Error	t Ratio	Prob> t
Intercept	115.6239	12.27059	9.42	<.0001*
Severity	-1.06498	0.257454	-4.14	0.0004*

Figure 4.16 JMP output for the simple linear regression model relating satisfaction to severity.

identical levels of x_1, x_2, \dots, x_k . The responses y_i from such near neighbors can be considered as repeat points and used to obtain an estimate of pure error. As a measure of the distance between any two points, for example, $x_{i1}, x_{i2}, \dots, x_{ik}$ and $x_{i'1}, x_{i'2}, \dots, x_{i'k}$, we will use the weighted sum of squared distance (WSSD)

$$D_{ii'}^2 = \sum_{j=1}^k \left[\frac{\hat{\beta}_j (x_{ij} - x_{i'j})}{\sqrt{MS_{\text{Res}}}} \right]^2 \quad (4.27)$$

Pairs of points that have small values of $D_{ii'}^2$ are “near neighbors,” that is, they are relatively close together in x space. Pairs of points for which $D_{ii'}^2$ is large (e.g., $D_{ii'}^2 \gg 1$) are widely separated in x space. The residuals at two points with a small value of $D_{ii'}^2$ can be used to obtain an estimate of pure error. The estimate is obtained from the range of the residuals at the points i and i' , say

$$E_i = |e_i - e_r|$$

There is a relationship between the range of a sample from a normal population and the population standard deviation. For samples of size 2, this relationship is

$$\hat{\sigma} = (1.128)^{-1} E = 0.886E$$

The quantity $\hat{\sigma}$ so obtained is an estimate of the standard deviation of pure error.

An efficient algorithm may be used to compute this estimate. A computer program for this algorithm is given in Montgomery, Martin, and Peck [1980]. First arrange the data points $x_{i1}, x_{i2}, \dots, x_{ik}$ in order of increasing \hat{y}_i . Note that points with very different values of \hat{y}_i cannot be near neighbors, but those with similar values of \hat{y}_i could be neighbors (or they could be near the same contour of constant \hat{y} but far apart in some x coordinates). Then:

1. Compute the values of D_{ii}^2 for all $n - 1$ pairs of points with adjacent values of \hat{y} . Repeat this calculation for the pairs of points separated by one, two, and three intermediate \hat{y} values. This will produce $4n - 10$ values of D_{ii}^2 .
2. Arrange the $4n - 10$ values of D_{ii}^2 found in 1 above in ascending order. Let E_u , $u = 1, 2, \dots, 4n - 10$, be the range of the residuals at these points.
3. For the first m values of E_u , calculate an estimate of the standard deviation of pure error as

$$\hat{\sigma} = \frac{0.886}{m} \sum_{u=1}^m E_u \quad (4.28)$$

Note that $\hat{\sigma}$ is based on the average range of the residuals associated with the m smallest values of D_{ii}^2 ; m must be chosen after inspecting the values of D_{ii}^2 . One should not include values of E_u in the calculations for which the weighted sum of squared distance is too large.

Example 4.10 The Delivery Time Data

We use the procedure described above to calculate an estimate of the standard deviation of pure error for the soft drink delivery time data from Example 3.1. Table 4.5 displays the calculation of D_{ii}^2 for pairs of points that, in terms of \hat{y} , are adjacent, one apart, two apart, and three apart. The R columns in this table identify the 15 smallest values of D_{ii}^2 . The residuals at these 15 pairs of points are used to estimate σ . These calculations yield $\hat{\sigma} = 1.969$ and are summarized in Table 4.6. From Table 3.4, we find that $\sqrt{MS_{\text{Res}}} = \sqrt{10.6239} = 3.259$. Now if there is no appreciable lack of fit, we would expect to find that $\hat{\sigma} = \sqrt{MS_{\text{Res}}}$. In this case $\sqrt{MS_{\text{Res}}}$ is about 65% larger than $\hat{\sigma}$, indicating some lack of fit. This could be due to the effects of regressors not presently in the model or the presence of one or more outliers. ■

TABLE 4.5 Calculation of D_{ii}^2 for Example 4.10

Near-Neighbor Calculations Delta Residuals and the Weighted Standardized Squared Distances of Near Neighbors																					
		Adjacent					1 Apart					2 Apart					3 Apart				
Observation	Ordered Fitted, y	Residual	Delta	D_{ii}^2	R ^a	Delta	D_{ii}^2	R	Delta	D_{ii}^2	R	Delta	D_{ii}^2	R	Delta	D_{ii}^2	R				
7	7.155	.845	.949	.3524E+00	4.080	.1001E+01	.302	.4814E+00	1.057	.1014E+01											
19	7.707	1.793	3.131	.2835E+00	12	.647	.6594E+00	2.006	.4989E+00	1.843	.1800E+01										
4	9.956	4.924	3.778	.6275E+00	5.137	.9544E-01	3	4.974	.1562E+01	3.897	.5965E+00										
2	10.354	1.146	1.359	.3412E+00	15	1.196	.2805E+00	11	1.119	.2696E+00	9	1.591	.2307E+01								
25	10.963	-.213	.163	.9489E+00	1.240	.2147E+00	6	.232	.9831E+00	.649	.1032E+01										
3	12.080	-.050	1.077	.3865E+00	.395	.2915E+01	.486	.2594E+01	3.498	.4775E+01											
13	12.473	1.027	1.471	.1198E+01	.591	.1042E+01	2.422	.2507E+01	.130	.2251E+01											
5	14.194	-.444	.881	.4869E-01	2	3.893	.2521E+00	8	1.601	.3159E+00	13	.155	.8768E+00								
17	14.914	.436	3.012	.3358E+00	14	.720	.2477E+00	7	.726	.5749E+00	.631	.1337E+01									
18	15.551	3.449	2.292	.1185E+00	5	3.738	.7636E+00	2.381	.2367E+01	1.072	.5341E+01										
8	16.673	1.157	1.446	.2805E+00	10	.089	.1483E+01	1.220	.4022E+01	3.771	.2307E+01										
6	18.400	-.290	1.357	.5851E+00	2.666	.2456E+01	2.325	.2915E+01	.303	.2470E+01											
14	18.682	1.068	1.309	.6441E+00	3.682	.5952E+01	1.661	.5121E+01	6.096	.4328E+00											
10	19.124	2.376	4.991	.1036E+02	2.969	.9107E+01	7.404	.1023E+01	1.705	.4412E+01											
21	20.514	-2.614	2.021	.1096E+00	4	2.414	.5648E+01	3.285	.2093E+01	1.993	.2117E+01										
12	21.593	-.593	4.435	.4530E+01	1.264	.1303E+01	4.015	.1321E+01	3.980	.4419E+01											
1	21.708	-5.028	5.699	.1227E+01	.421	.1219E+01	.455	.3553E+00	4.365	.3121E+01											
15	23.329	.671	5.279	.7791E-04	1	5.244	.9269E+00	1.334	.2341E+01	1.566	.1316E+02										
23	23.358	-4.608	.035	.9124E+00	3.945	.2316E+01	6.845	.1315E+02	1.180	.1772E+02											
24	24.403	-4.573	3.910	.1370E+01	6.810	.1578E+02	1.215	.2026E+02	.886	.8023E+02											
16	29.663	-.663	2.900	.8999E+01	5.125	.1204E+02	3.024	.6294E+02	8.083	.1074E+03											
11	38.093	2.237	8.025	.3767E+00	5.924	.2487E+02	13.208	.5978E+02													
20	40.888	-5.788	2.101	.1994E+02																	
22	56.007	-3.687	11.106	.1216E+02																	
9	71.820	7.420																			

^a Column R gives the rank order of the 15 smallest D_{ii}^2 values.

TABLE 4.6 Calculation of $\hat{\sigma}$ for Example 4.10

Number	Standard Deviation Estimated from Residuals of Neighboring Observations				
	Cumulative Standard Deviation	Ordered by D_{ii}^2			
		D_{ii}^2	Observation	Observation	Delta Residual
1	.4677E + 01	.7791E - 04	15	23	5.2788
2	.2729E + 01	.4859E - 01	5	17	0.8807
3	.3336E + 01	.9544E - 01	4	25	5.1369
4	.2950E + 01	.1096E + 00	21	12	2.0211
5	.2766E + 01	.1185E + 00	18	8	2.2920
6	.2488E + 01	.2147E + 00	25	13	1.2396
7	.2224E + 01	.2477E + 00	17	8	0.7203
8	.2377E + 01	.2521E + 00	5	18	3.8930
9	.2125E + 01	.2696E + 00	2	13	0.1194
10	.2040E + 01	.2805E + 00	8	6	1.4462
11	.1951E + 01	.2805E + 00	2	3	1.1962
12	.2020E + 01	.2835E + 00	19	4	3.1312
13	.1973E + 01	.3159E + 00	5	8	1.6010
14	.2023E + 01	.3358E + 00	17	18	3.0123
15	.1969E + 01	.3412E + 00	2	25	1.3590
16	.1898E + 01	.3524E + 00	7	19	0.9486
17	.1810E + 01	.3553E + 00	1	24	0.4552
18	.2105E + 01	.3767E + 00	11	20	8.0255
19	.2044E + 01	.3865E + 00	3	13	1.0768
20	.2212E + 01	.4328E + 00	14	1	6.0956
21	.2119E + 01	.4814E + 00	7	2	0.3018
22	.2104E + 01	.4989E + 00	19	25	2.0058
23	.2040E + 01	.5749E + 00	17	6	0.7259
24	.2005E + 01	.5851E + 00	6	14	1.3571
25	.2063E + 01	.5965E + 00	4	13	3.8973
26	.2113E + 01	.6275E + 00	4	2	3.7780
27	.2077E + 01	.6441E + 00	14	10	1.3089
28	.2024E + 01	.6594E + 00	19	2	0.6468
29	.2068E + 01	.7636E + 00	18	6	3.7382
30	.2004E + 01	.8768E + 00	5	6	0.1548
31	.1940E + 01	.9124E + 00	23	24	0.0347
32	.2025E + 01	.9269E + 00	15	24	5.2441
33	.1968E + 01	.9489E + 00	25	3	0.1628
34	.1916E + 01	.9831E + 00	25	5	0.2318
35	.1964E + 01	.1001E + 01	7	4	4.0797
36	.1936E + 01	.1014E + 01	7	25	1.0572
37	.2061E + 01	.1023E + 01	10	1	7.4045
38	.2022E + 01	.1032E + 01	25	17	0.6489
39	.1983E + 01	.1042E + 01	13	17	0.5907
40	.1966E + 01	.1198E + 01	13	5	1.4714

PROBLEMS

- 4.1** Consider the simple regression model fit to the National Football League team performance data in Problem 2.1.
- Construct a normal probability plot of the residuals. Does there seem to be any problem with the normality assumption?
 - Construct and interpret a plot of the residuals versus the predicted response.
 - Plot the residuals versus the team passing yardage, x_2 . Does this plot indicate that the model will be improved by adding x_2 to the model?
- 4.2** Consider the multiple regression model fit to the National Football League team performance data in Problem 3.1.
- Construct a normal probability plot of the residuals. Does there seem to be any problem with the normality assumption?
 - Construct and interpret a plot of the residuals versus the predicted response.
 - Construct plots of the residuals versus each of the regressor variables. Do these plots imply that the regressor is correctly specified?
 - Construct the partial regression plots for this model. Compare the plots with the plots of residuals versus regressors from part c above. Discuss the type of information provided by these plots.
 - Compute the studentized residuals and the R -student residuals for this model. What information is conveyed by these scaled residuals?
- 4.3** Consider the simple linear regression model fit to the solar energy data in Problem 2.3.
- Construct a normal probability plot of the residuals. Does there seem to be any problem with the normality assumption?
 - Construct and interpret a plot of the residuals versus the predicted response.
- 4.4** Consider the multiple regression model fit to the gasoline mileage data in Problem 3.5.
- Construct a normal probability plot of the residuals. Does there seem to be any problem with the normality assumption?
 - Construct and interpret a plot of the residuals versus the predicted response.
 - Construct and interpret the partial regression plots for this model.
 - Compute the studentized residuals and the R -student residuals for this model. What information is conveyed by these scaled residuals?
- 4.5** Consider the multiple regression model fit to the house price data in Problem 3.7.
- Construct a normal probability plot of the residuals. Does there seem to be any problem with the normality assumption?
 - Construct and interpret a plot of the residuals versus the predicted response.
 - Construct the partial regression plots for this model. Does it seem that some variables currently in the model are not necessary?
 - Compute the studentized residuals and the R -student residuals for this model. What information is conveyed by these scaled residuals?

- 4.6** Consider the simple linear regression model fit to the oxygen purity data in Problem 2.7.
- Construct a normal probability plot of the residuals. Does there seem to be any problem with the normality assumption?
 - Construct and interpret a plot of the residuals versus the predicted response.
- 4.7** Consider the simple linear regression model fit to the weight and blood pressure data in Problem 2.10.
- Construct a normal probability plot of the residuals. Does there seem to be any problem with the normality assumption?
 - Construct and interpret a plot of the residuals versus the predicted response.
 - Suppose that the data were collected in the order shown in the table. Plot the residuals versus time order and comment on the plot.
- 4.8** Consider the simple linear regression model fit to the steam plant data in Problem 2.12.
- Construct a normal probability plot of the residuals. Does there seem to be any problem with the normality assumption?
 - Construct and interpret a plot of the residuals versus the predicted response.
 - Suppose that the data were collected in the order shown in the table. Plot the residuals versus time order and comment on the plot.
- 4.9** Consider the simple linear regression model fit to the ozone data in Problem 2.13.
- Construct a normal probability plot of the residuals. Does there seem to be any problem with the normality assumption?
 - Construct and interpret a plot of the residuals versus the predicted response.
 - Plot the residuals versus time order and comment on the plot.
- 4.10** Consider the simple linear regression model fit to the copolyester viscosity data in Problem 2.14.
- Construct a normal probability plot of the unscaled residuals. Does there seem to be any problem with the normality assumption?
 - Repeat part a using the studentized residuals. Is there any substantial difference in the two plots?
 - Construct and interpret a plot of the residuals versus the predicted response.
- 4.11** Consider the simple linear regression model fit to the toluene–tetralin viscosity data in Problem 2.15.
- Construct a normal probability plot of the residuals. Does there seem to be any problem with the normality assumption?
 - Construct and interpret a plot of the residuals versus the predicted response.
- 4.12** Consider the simple linear regression model fit to the tank pressure and volume data in Problem 2.16.
- Construct a normal probability plot of the residuals. Does there seem to be any problem with the normality assumption?

- b. Construct and interpret a plot of the residuals versus the predicted response.
 - c. Suppose that the data were collected in the order shown in the table. Plot the residuals versus time order and comment on the plot.
- 4.13** Problem 3.8 asked you to fit two different models to the chemical process data in Table B.5. Perform appropriate residual analyses for both models. Discuss the results of these analyses. Calculate the PRESS statistic for both models. Do the residual plots and PRESS provide any insight regarding the best choice of model for the data?
- 4.14** Problems 2.4 and 3.5 asked you to fit two different models to the gasoline mileage data in Table B.3. Calculate the PRESS statistic for these two models. Based on this statistic, which model is most likely to provide better predictions of new data?
- 4.15** In Problem 3.9, you were asked to fit a model to the tube-flow reactor data in Table B.6.
- a. Construct a normal probability plot of the residuals. Does there seem to be any problem with the normality assumption?
 - b. Construct and interpret a plot of the residuals versus the predicted response.
 - c. Construct the partial regression plots for this model. Does it seem that some variables currently in the model are not necessary?
- 4.16** In Problem 3.12, you were asked to fit a model to the clathrate formation data in Table B.8.
- a. Construct a normality plot of the residuals from the full model. Does there seem to be any problem with the normality assumption?
 - b. Construct and interpret a plot of the residuals versus the predicted response.
 - c. In Problem 3.12, you were asked to fit a second model. Compute the PRESS statistic for both models. Based on this statistic, which model is most likely to provide better predictions of new data?
- 4.17** In Problem 3.14, you were asked to fit a model to the kinematic viscosity data in Table B.10.
- a. Construct a normality plot of the residuals from the full model. Does there seem to be any problem with the normality assumption?
 - b. Construct and interpret a plot of the residuals versus the predicted response.
 - c. In Problem 3.14, you were asked to fit a second model. Compute the PRESS statistic for both models. Based on this statistic, which model is most likely to provide better predictions of new data?
- 4.18** Coteron, Sanchez, Martinez, and Aracil (“Optimization of the Synthesis of an Analogue of Jojoba Oil Using a Fully Central Composite Design,” *Canadian Journal of Chemical Engineering*, 1993) studied the relationship of reaction temperature x_1 , initial amount of catalyst x_2 , and pressure x_3 on the yield of a synthetic analogue to jojoba oil. The following table summarizes the experimental results.

x_1	x_2	x_3	y
-1	-1	-1	17
1	-1	-1	44
-1	1	-1	19
1	1	-1	46
-1	-1	1	7
1	-1	1	55
-1	1	1	15
1	1	1	41
0	0	0	29
0	0	0	28.5
0	0	0	30
0	0	0	27
0	0	0	28

- a. Perform a thorough analysis of the results including residual plots.
- b. Perform the appropriate test for lack of fit.

4.19 Derringer and Suich (“Simultaneous Optimization of Several Response Variables,” *Journal of Quality Technology*, 1980) studied the relationship of an abrasion index for a tire tread compound in terms of three factors: x_1 , hydrated silica level; x_2 , silane coupling agent level; and x_3 , sulfur level. The following table gives the actual results.

x_1	x_2	x_3	y
-1	-1	1	102
1	-1	-1	120
-1	1	-1	117
1	1	1	198
-1	-1	-1	103
1	-1	1	132
-1	1	1	132
1	1	-1	139
0	0	0	133
0	0	0	133
0	0	0	140
0	0	0	142
0	0	0	145
0	0	0	142

- a. Perform a thorough analysis of the results including residual plots.
- b. Perform the appropriate test for lack of fit.

4.20 Myers Montgomery and Anderson-Cook (*Response Surface Methodology 3rd edition*, Wiley, New York, 2009) discuss an experiment to determine the influence of five factors:

- x_1 —acid bath temperature
- x_2 —cascade acid concentration
- x_3 —water temperature
- x_4 —sulfide concentration
- x_5 —amount of chlorine bleach

on an appropriate measure of the whiteness of rayon (y). The engineers conducting this experiment wish to minimize this measure. The experimental results follow.

Acid Temp.	Acid Conc.	Water Temp.	Sulfide Conc.	Amount of Bleach	y
35	0.3	82	0.2	0.3	76.5
35	0.3	82	0.3	0.5	76.0
35	0.3	88	0.2	0.5	79.9
35	0.3	88	0.3	0.3	83.5
35	0.7	82	0.2	0.5	89.5
35	0.7	82	0.3	0.3	84.2
35	0.7	88	0.2	0.3	85.7
35	0.7	88	0.3	0.5	99.5
55	0.3	82	0.2	0.5	89.4
55	0.3	82	0.3	0.3	97.5
55	0.3	88	0.2	0.3	103.2
55	0.3	88	0.3	0.5	108.7
55	0.7	82	0.2	0.3	115.2
55	0.7	82	0.3	0.5	111.5
55	0.7	88	0.2	0.5	102.3
55	0.7	88	0.3	0.3	108.1
25	0.5	85	0.25	0.4	80.2
65	0.5	85	0.25	0.4	89.1
45	0.1	85	0.25	0.4	77.2
45	0.9	85	0.25	0.4	85.1
45	0.5	79	0.25	0.4	71.5
45	0.5	91	0.25	0.4	84.5
45	0.5	85	0.15	0.4	77.5
45	0.5	85	0.35	0.4	79.2
45	0.5	85	0.25	0.2	71.0
45	0.5	85	0.25	0.6	90.2

- a. Perform a thorough analysis of the results including residual plots.
 - b. Perform the appropriate test for lack of fit.
- 4.21** Consider the test for lack of fit. Find $E(MS_{PE})$ and $E(MS_{LOF})$.
- 4.22** Table B.14 contains data on the transient points of an electronic inverter. Using only the regressors x_1, \dots, x_4 , fit a multiple regression model to these data.

- a. Investigate the adequacy of the model.
 - b. Suppose that observation 2 was recorded incorrectly. Delete this observation, refit the model, and perform a thorough residual analysis. Comment on the difference in results that you observe.
- 4.23** Consider the advertising data given in Problem 2.18.
- a. Construct a normal probability plot of the residuals from the full model. Does there seem to be any problem with the normality assumption?
 - b. Construct and interpret a plot of the residuals versus the predicted response.
- 4.24** Consider the air pollution and mortality data given in Problem 3.15 and Table B.15.
- a. Construct a normal probability plot of the residuals from the full model. Does there seem to be any problem with normality assumption?
 - b. Construct and interpret a plot of the residuals versus the predicted response.
- 4.25** Consider the life expectancy data given in Problem 3.16 and Table B.16.
- a. For each model construct a normal probability plot of the residuals from the full model. Does there seem to be any problem with the normality assumption?
 - b. For each model construct and interpret a plot of the residuals versus the predicted response.
- 4.26** Consider the multiple regression model for the patient satisfaction data in Section 3.6. Analyse the residuals from this model and comment on model adequacy.
- 4.27** Consider the fuel consumption data in Table B.18. For the purposes of this exercise, ignore regressor x_1 . Perform a thorough residual analysis of these data. What conclusions do you draw from this analysis?
- 4.28** Consider the wine quality of young red wines data in Table B.19. For the purposes of this exercise, ignore regressor x_1 . Perform a thorough residual analysis of these data. What conclusions do you draw from this analysis?
- 4.29** Consider the methanol oxidation data in Table B.20. Perform a thorough analysis of these data. What conclusions do you draw from this residual analysis?

CHAPTER 5

TRANSFORMATIONS AND WEIGHTING TO CORRECT MODEL INADEQUACIES

5.1 INTRODUCTION

Chapter 4 presented several techniques for checking the adequacy of the linear regression model. Recall that regression model fitting has several implicit assumptions, including the following:

1. The model errors have mean zero and constant variance and are uncorrelated.
2. The model errors have a normal distribution—this assumption is made in order to conduct hypothesis tests and construct CIs—under this assumption, the errors are independent.
3. The form of the model, including the specification of the regressors, is correct.

Plots of residuals are very powerful methods for detecting violations of these basic regression assumptions. This form of model adequacy checking should be conducted for every regression model that is under serious consideration for use in practice.

In this chapter, we focus on methods and procedures for building regression models when some of the above assumptions are violated. We place considerable emphasis on **data transformation**. It is not unusual to find that when the response and/or the regressor variables are expressed in the correct scale of measurement or metric, certain violations of assumptions, such as inequality of variance, are no longer present. Ideally, the choice of metric should be made by the engineer or scientist with **subject-matter knowledge**, but there are many situations where this

information is not available. In these cases, a data transformation may be chosen heuristically or by some analytical procedure.

The method of weighted least squares is also useful in building regression models in situations where some of the underlying assumptions are violated. We will illustrate how weighted least squares can be used when the equal-variance assumption is not appropriate. This technique will also prove essential in subsequent chapters when we consider other methods for handling nonnormal response variables.

5.2 VARIANCE-STABILIZING TRANSFORMATIONS

The assumption of **constant variance** is a basic requirement of regression analysis. A common reason for the violation of this assumption is for the response variable y to follow a probability distribution in which the variance is functionally related to the mean. For example, if y is a Poisson random variable in a simple linear regression model, then the variance of y is equal to the mean. Since the mean of y is related to the regressor variable x , the variance of y will be proportional to x . Variance-stabilizing transformations are often useful in these cases. Thus, if the distribution of y is Poisson, we could regress $y' = \sqrt{y}$ against x since the variance of the square root of a Poisson random variable is independent of the mean. As another example, if the response variable is a proportion ($0 \leq y_i \leq 1$) and the plot of the residuals versus \hat{y}_i has the double-bow pattern of Figure 4.5c, the arcsin transformation $y' = \sin^{-1}(\sqrt{y})$ is appropriate.

Several commonly used variance-stabilizing transformations are summarized in Table 5.1. The **strength** of a transformation depends on the amount of curvature that it induces. The transformations given in Table 5.1 range from the relatively mild square root to the relatively strong reciprocal. Generally speaking, a mild transformation applied over a relatively narrow range of values (e.g., $y_{\max}/y_{\min} < 2, 3$) has little effect. On the other hand, a strong transformation over a wide range of values will have a dramatic effect on the analysis.

Sometimes we can use prior experience or theoretical considerations to guide us in selecting an appropriate transformation. However, in many cases we have no a priori reason to suspect that the error variance is not constant. Our first indication of the problem is from inspection of scatter diagrams or residual analysis. In these cases the appropriate transformation may be selected **empirically**.

TABLE 5.1 Useful Variance-Stabilizing Transformations

Relationship of σ^2 to $E(y)$	Transformation
$\sigma^2 \propto \text{constant}$	$y' = y$ (no transformation)
$\sigma^2 \propto E(y)$	$y' = \sqrt{y}$ (square root; Poisson data)
$\sigma^2 \propto E(y)[1 - E(y)]$	$y' = \sin^{-1}(\sqrt{y})$ (arcsin; binomial proportions $0 \leq y_i \leq 1$)
$\sigma^2 \propto [E(y)]^2$	$y' = \ln(y)$ (log)
$\sigma^2 \propto [E(y)]^3$	$y' = y^{-1/2}$ (reciprocal square root)
$\sigma^2 \propto [E(y)]^4$	$y' = y^{-1}$ (reciprocal)

It is important to detect and correct a nonconstant error variance. If this problem is not eliminated, the least-squares estimators will still be unbiased, but they will no longer have the minimum-variance property. This means that the regression coefficients will have larger standard errors than necessary. The effect of the transformation is usually to give more precise estimates of the model parameters and increased sensitivity for the statistical tests.

When the response variable has been reexpressed, the predicted values are in the transformed scale. It is often necessary to convert the predicted values back to the original units. Unfortunately, applying the inverse transformation directly to the predicted values gives an estimate of the median of the distribution of the response instead of the mean. It is usually possible to devise a method for obtaining unbiased predictions in the original units. Procedures for producing unbiased point estimates for several standard transformations are given by Neyman and Scott [1960]. Miller [1984] also suggests some simple solutions to this problem. Confidence or prediction intervals may be directly converted from one metric to another, as these interval estimates are percentiles of a distribution and percentiles are unaffected by transformation. However, there is no assurance that the resulting intervals in the original units are the shortest possible intervals. For further discussion, see Land [1974].

Example 5.1 The Electric Utility Data

An electric utility is interested in developing a model relating peak-hour demand (y) to total energy usage during the month (x). This is an important planning problem because while most customers pay directly for energy usage (in kilowatt-hours), the generation system must be large enough to meet the maximum demand imposed. Data for 53 residential customers for the month of August are shown in Table 5.2, and a scatter diagram is given in Figure 5.1. As a starting point, a simple linear regression model is assumed, and the least-squares fit is

$$\hat{y} = -0.8313 + 0.00368x$$

The analysis of variance is shown in Table 5.3. For this model $R^2 = 0.7046$; that is, about 70% of the variability in demand is accounted for by the straight-line fit to energy usage. The summary statistics do not reveal any obvious problems with this model.

A plot of the R -student residuals versus the fitted values \hat{y}_i is shown in Figure 5.2. The residuals form an outward-opening funnel, indicating that the error variance is increasing as energy consumption increases. A transformation may be helpful in correcting this model inadequacy. To select the form of the transformation, note that the response variable y may be viewed as a “count” of the number of kilowatts used by a customer during a particular hour. The simplest probabilistic model for count data is the Poisson distribution. This suggests regressing $y^* = \sqrt{y}$ on x as a variance-stabilizing transformation. The resulting least-squares fit is

$$\hat{y}^* = 0.5822 + 0.0009529x$$

The R -student values from this least-squares fit are plotted against \hat{y}_i^* in Figure 5.3. The impression from examining this plot is that the variance is stable;

TABLE 5.2 Demand (y) and Energy Usage (x) Data for 53 Residential Customers, August

Customer	x (kWh)	y (kW)	Customer	x (kWh)	y (kW)
1	679	0.79	27	837	4.20
2	292	0.44	28	1748	4.88
3	1012	0.56	29	1381	3.48
4	493	0.79	30	1428	7.58
5	582	2.70	31	1255	2.63
6	1156	3.64	32	1777	4.99
7	997	4.73	33	370	0.59
8	2189	9.50	34	2316	8.19
9	1097	5.34	35	1130	4.79
10	2078	6.85	36	463	0.51
11	1818	5.84	37	770	1.74
12	1700	5.21	38	724	4.10
13	747	3.25	39	808	3.94
14	2030	4.43	40	790	0.96
15	1643	3.16	41	783	3.29
16	414	0.50	42	406	0.44
17	354	0.17	43	1242	3.24
18	1276	1.88	44	658	2.14
19	745	0.77	45	1746	5.71
20	435	1.39	46	468	0.64
21	540	0.56	47	1114	1.90
22	874	1.56	48	413	0.51
23	1543	5.28	49	1787	8.33
24	1029	0.64	50	3560	14.94
25	710	4.00	51	1495	5.11
26	1434	0.31	52	2221	3.85
			53	1526	3.93

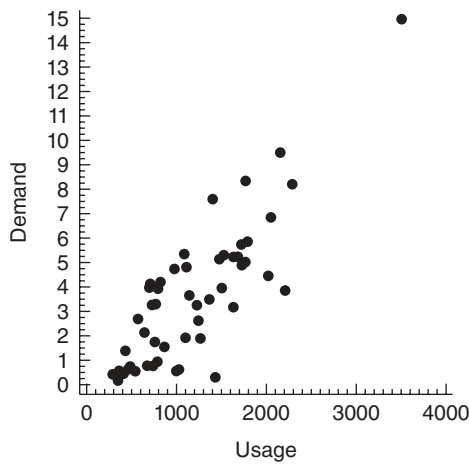

Figure 5.1 Scatter diagram of the energy demand (kW) versus energy usage (kWh), Example 5.1.

TABLE 5.3 Analysis of Variance for Regression of y on x for Example 5.1

Source of Variation	Sum of Squares	Degrees of Freedom	Mean Square	F_0	P Value
Regression	303.6331	1	302.6331	121.66	<0.0001
Residual	126.8660	51	2.4876		
Total	429.4991	52			

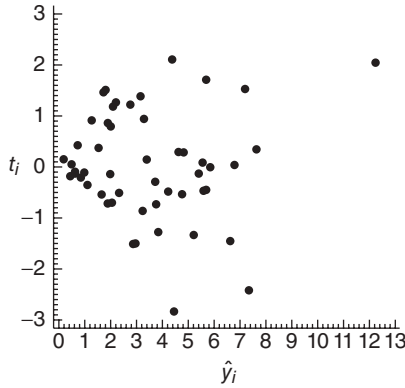

Figure 5.2 Plot of R -student values t_i versus fitted values \hat{y}_i , Example 5.1.

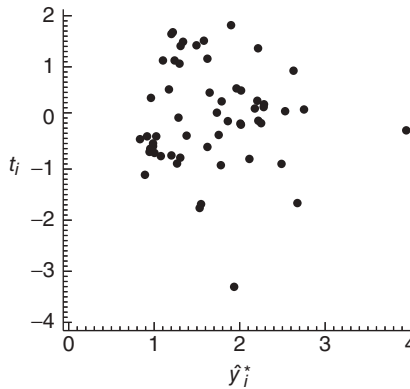

Figure 5.3 Plot of R -student values t_i versus fitted values \hat{y}_i^* for the transformed data, Example 5.1.

consequently, we conclude that the transformed model is adequate. Note that there is one suspiciously large residual (customer 26) and one customer whose energy usage is somewhat large (customer 50). The effect of these two points on the fit should be studied further before the model is released for use. ■

5.3 TRANSFORMATIONS TO LINEARIZE THE MODEL

The assumption of a linear relationship between y and the regressors is the usual starting point in regression analysis. Occasionally we find that this assumption is inappropriate. Nonlinearity may be detected via the lack-of-fit test described in Section 4.5 or from scatter diagrams, the matrix of scatterplots, or residual plots such as the partial regression plot. Sometimes prior experience or theoretical considerations may indicate that the relationship between y and the regressors is not linear. In some cases a nonlinear function can be linearized by using a suitable transformation. Such nonlinear models are called **intrinsically** or **transformably linear**.

Several linearizable functions are shown in Figure 5.4. The corresponding nonlinear functions, transformations, and resulting linear forms are shown in Table 5.4. When the scatter diagram of y against x indicates curvature, we may be able to match the observed behavior of the plot to one of the curves in Figure 5.4 and use the linearized form of the function to represent the data.

To illustrate a nonlinear model that is intrinsically linear, consider the exponential function

$$y = \beta_0 e^{\beta_1 x} \varepsilon$$

This function is intrinsically linear since it can be transformed to a straight line by a **logarithmic transformation**

$$\ln y = \ln \beta_0 + \beta_1 x + \ln \varepsilon$$

or

$$y' = \beta'_0 + \beta_1 x + \varepsilon'$$

as shown in Table 5.4. This transformation requires that the transformed error terms $\varepsilon' = \ln \varepsilon$ are normally and independently distributed with mean zero and variance σ_2 . This implies that the multiplicative error ε in the original model is log normally distributed. We should look at the residuals from the transformed model to see if the assumptions are valid. Generally if x and/or y are in the proper metric, the usual least-squares assumptions are more likely to be satisfied, although it is no unusual to discover at this stage that a nonlinear model is preferable (see Chapter 12).

Various types of reciprocal transformations are also useful. For example, the model

$$y = \beta_0 + \beta_1 \left(\frac{1}{x} \right) + \varepsilon$$

can be linearized by using the **reciprocal transformation** $x' = 1/x$. The resulting linearized model is

$$y = \beta_0 + \beta_1 x' + \varepsilon$$

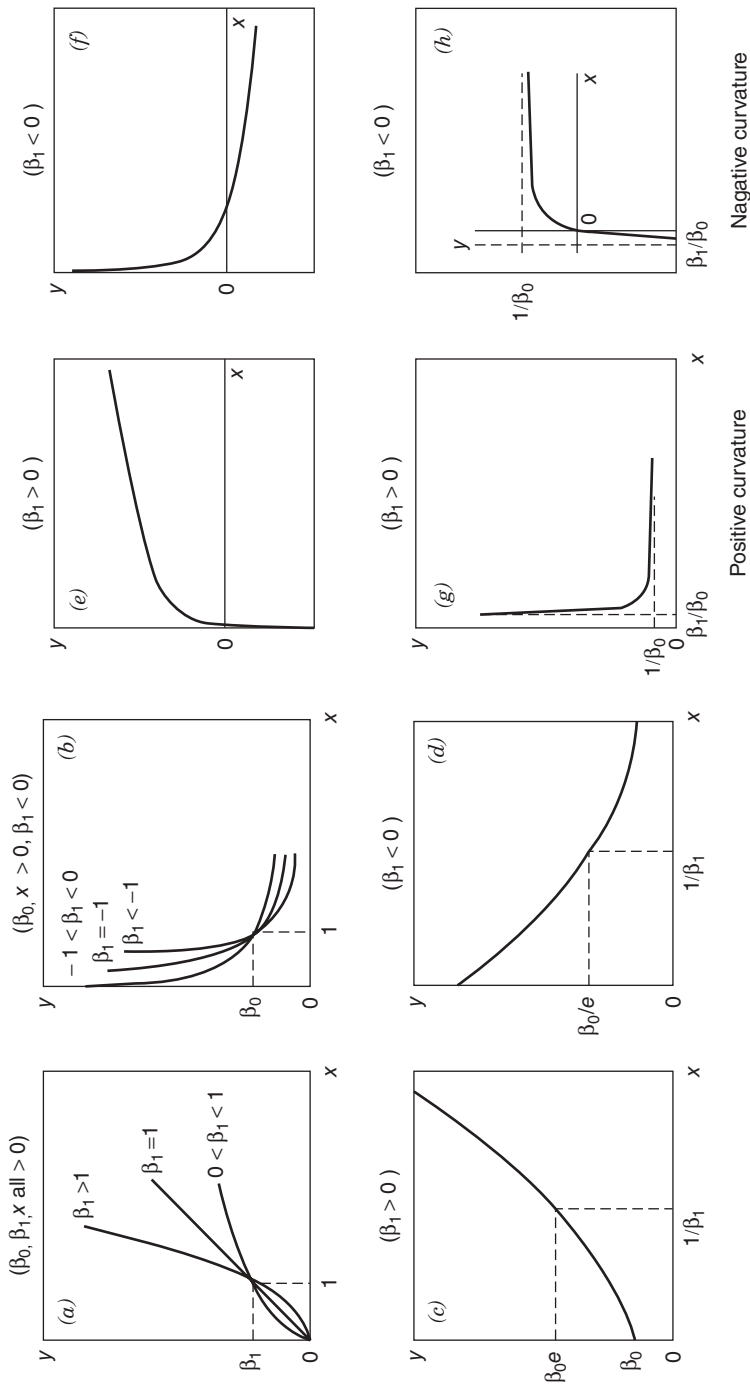

Figure 5.4 Linearizable functions. (From Daniel and Wood [1980], used with permission of the publisher.)

TABLE 5.4 Linearizable Functions and Corresponding Linear Form

Figure	Linearizable Function	Transformation	Linear Form
5.4a, b	$y = \beta_0 x^{\beta_1}$	$y' = \log y, x' = \log x$	$y' = \log \beta_0 + \beta_1 x'$
5.4c, d	$y = \beta_0 e^{\beta_1 x}$	$y' = \ln y$	$y' = \ln \beta_0 + \beta_1 x$
5.4e, f	$y = \beta_0 + \beta_1 \log x$	$x' = \log x$	$y' = \beta_0 + \beta_1 x'$
5.4g, h	$y = \frac{x}{\beta_0 x - \beta_1}$	$y' = \frac{1}{y}, x' = \frac{1}{x}$	$y' = \beta_0 - \beta_1 x'$

Other models that can be linearized by reciprocal transformations are

$$\frac{1}{y} = \beta_0 + \beta_1 x + \varepsilon$$

and

$$y = \frac{x}{\beta_0 x - \beta_1 + \varepsilon}$$

This last model is illustrated in Figures 5.4g, h.

When transformations such as those described above are employed, the least-squares estimator has least-squares properties with respect to the transformed data, not the original data. For additional reading on transformations, see Atkinson [1983, 1985], Box, Hunter, and Hunter [1978], Carroll and Ruppert [1985], Dolby [1963], Mosteller and Tukey [1977, Chs. 4–6], Myers [1990], Smith [1972], and Tukey [1957].

Example 5.2 The Windmill Data

A research engineer is investigating the use of a windmill to generate electricity. He has collected data on the DC output from his windmill and the corresponding wind velocity. The data are plotted in Figure 5.5 and listed in Table 5.5.

Inspection of the scatter diagram indicates that the relationship between DC output (y) and wind velocity (x) may be nonlinear. However, we initially fit a straight-line model to the data. The regression model is

$$\hat{y} = 0.1309 + 0.2411x$$

The summary statistics for this model are $R^2 = 0.8745$, $MS_{Res} = 0.0557$, and $F_0 = 160.26$ (the P value is <0.0001). Column A of Table 5.6 shows the fitted values and residuals obtained from this model. In Table 5.6 the observations are arranged in order of increasing wind speed. The residuals show a distinct pattern, that is, they move systematically from negative to positive and back to negative again as wind speed increases.

A plot of the residuals versus \hat{y}_i is shown in Figure 5.6. This residual plot indicates model inadequacy and implies that the linear relationship has not captured all of the information in the wind speed variable. Note that the curvature that was

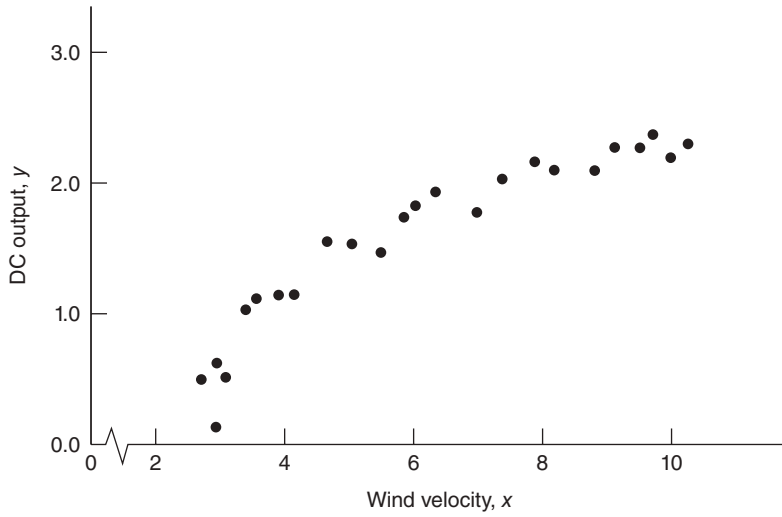

Figure 5.5 Plot of DC output y versus wind velocity x for the windmill data.

TABLE 5.5 Observed Values y_i and Regressor Variable x_i for Example 5.2

Observation Number, i	Wind Velocity, x_i (mph)	DC Output, y_i
1	5.00	1.582
2	6.00	1.822
3	3.40	1.057
4	2.70	0.500
5	10.00	2.236
6	9.70	2.386
7	9.55	2.294
8	3.05	0.558
9	8.15	2.166
10	6.20	1.866
11	2.90	0.653
12	6.35	1.930
13	4.60	1.562
14	5.80	1.737
15	7.40	2.088
16	3.60	1.137
17	7.85	2.179
18	8.80	2.112
19	7.00	1.800
20	5.45	1.501
21	9.10	2.303
22	10.20	2.310
23	4.10	1.194
24	3.95	1.144
25	2.45	0.123

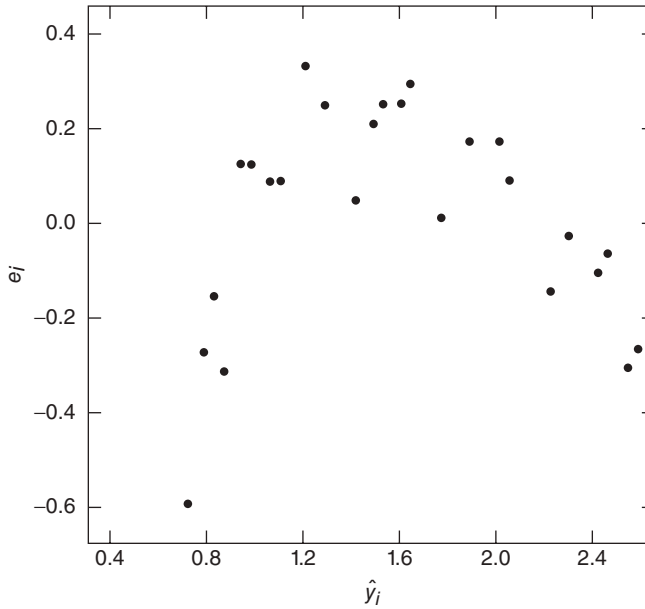

Figure 5.6 Plot of residuals e_i versus fitted values \hat{y}_i for the windmill data.

apparent in the scatter diagram of Figure 5.5 is greatly amplified in the residual plot. Clearly some other model form must be considered.

We might initially consider using a quadratic model such as

$$y = \beta_0 + \beta_1 x + \beta_2 x^2 + \varepsilon$$

to account for the apparent curvature. However, the scatter diagram Figure 5.5 suggests that as wind speed increases, DC output approaches an upper limit of approximately 2.5. This is also consistent with the theory of windmill operation. Since the quadratic model will eventually bend downward as wind speed increases, it would not be appropriate for these data. A more reasonable model for the windmill data that incorporates an upper asymptote would be

$$y = \beta_0 + \beta_1 \left(\frac{1}{x} \right) + \varepsilon$$

Figure 5.7 is a scatter diagram with the transformed variable $x' = 1/x$. This plot appears linear, indicating that the reciprocal transformation is appropriate. The fitted regression model is

$$\hat{y} = 2.9789 - 6.9345x'$$

The summary statistics for this model are $R^2 = 0.9800$, $MS_{\text{Res}} = 0.0089$, and $F_0 = 1128.43$ (the P value is <0.0001).

The fitted values and corresponding residuals from the transformed model are shown in column B of Table 5.6. A plot of R -student values from the transformed model versus \hat{y} is shown in Figure 5.8. This plot does not reveal any serious problem

with inequality of variance. Other residual plots are satisfactory, and so because there is no strong signal of model inadequacy, we conclude that the transformed model is satisfactory. ■

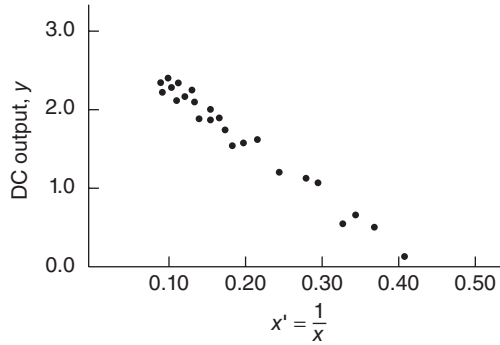

Figure 5.7 Plot of DC output versus $x' = 1/x$ for the windmill data.

TABLE 5.6 Observations y_i Ordered by Increasing Wind Velocity, Fitted Values \hat{y}_i , and Residuals e_i for Both Models for Example 5.2

Wind Velocity, x_i	DC Output y_i	A. Straight-Line Model $\hat{y} = \hat{\beta}_0 + \hat{\beta}_1 x$		B. Transformed Model $\hat{y} = \hat{\beta}_0 + \hat{\beta}_1 (1/x)$	
		\hat{y}_i	e_i	y_i	e_i
2.45	0.123	0.7217	-0.5987	0.1484	-0.0254
2.70	0.500	0.7820	-0.2820	0.4105	0.0895
2.90	0.653	0.8302	-0.1772	0.5876	0.0654
3.05	0.558	0.8664	-0.3084	0.7052	-0.1472
3.40	1.057	0.9508	0.1062	0.9393	0.1177
3.60	1.137	0.9990	0.1380	1.0526	0.0844
3.95	1.144	1.0834	0.0606	1.2233	-0.0793
4.10	1.194	1.1196	0.0744	1.2875	-0.0935
4.60	1.562	1.2402	0.3218	1.4713	0.0907
5.00	1.582	1.3366	0.2454	1.5920	-0.0100
5.45	1.501	1.4451	0.0559	1.7065	-0.2055
5.80	1.737	1.5295	0.2075	1.7832	-0.0462
6.00	1.822	1.5778	0.2442	1.8231	-0.0011
6.20	1.866	1.6260	0.2400	1.8604	0.0056
6.35	1.930	1.6622	0.2678	1.8868	0.0432
7.00	1.800	1.8189	-0.0189	1.9882	-0.1882
7.40	2.088	1.9154	0.1726	2.0418	0.0462
7.85	2.179	2.0239	0.1551	2.0955	0.0835
8.15	2.166	2.0962	0.0698	2.1280	0.0380
8.80	2.112	2.2530	-0.1410	2.1908	-0.0788
9.10	2.303	2.3252	-0.0223	2.2168	0.0862
9.55	2.294	2.4338	-0.1398	2.2527	-0.1472
9.70	2.386	2.4700	-0.0840	2.2640	0.1220
10.00	2.236	2.5424	-0.3064	2.2854	-0.0494
10.20	2.310	2.5906	-0.2906	2.2990	0.0110

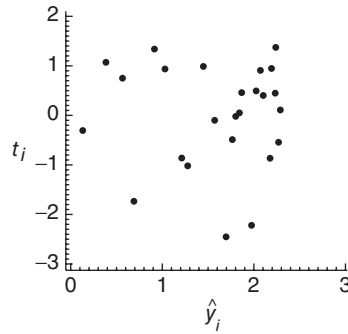

Figure 5.8 Plot of R -student values t_i versus fitted values \hat{y}_i for the transformed model for the windmill data.

5.4 ANALYTICAL METHODS FOR SELECTING A TRANSFORMATION

While in many instances transformations are selected empirically, more formal, objective techniques can be applied to help specify an appropriate transformation. This section will discuss and illustrate analytical procedures for selecting transformations on both the response and regressor variables.

5.4.1 Transformations on y : The Box-Cox Method

Suppose that we wish to transform y to correct nonnormality and/or nonconstant variance. A useful class of transformations is the **power transformation** y^λ , where λ is a parameter to be determined (e.g., $\lambda = \frac{1}{2}$ means use \sqrt{y} as the response). Box and Cox [1964] show how the parameters of the regression model and λ can be estimated simultaneously using the method of maximum likelihood.

In thinking about the power transformation y^λ a difficulty arises when $\lambda = 0$; namely, as λ approaches zero, y^λ approaches unity. This is obviously a problem, since it is meaningless to have all of the response values equal to a constant. One approach to solving this difficulty (we call this a discontinuity at $\lambda = 0$) is to use $(y^\lambda - 1)/\lambda$ as the response variable. This solves the discontinuity problem, because as λ tends to zero, $(y^\lambda - 1)/\lambda$ goes to a limit of $\ln y$. However, there is still a problem, because as λ changes, the values of $(y^\lambda - 1)/\lambda$ change dramatically, so it would be difficult to compare model summary statistics for models with different values of λ .

The appropriate procedure is to use

$$y^{(\lambda)} = \begin{cases} \frac{y^\lambda - 1}{\lambda \dot{y}^{\lambda-1}}, & \lambda \neq 0 \\ \dot{y} \ln y, & \lambda = 0 \end{cases} \tag{5.1}$$

where $\dot{y} = \ln^{-1}[1/n \sum_{i=1}^n \ln y_i]$ is the geometric mean of the observations, and fit the model

$$\mathbf{y}^{(\lambda)} = \mathbf{X}\boldsymbol{\beta} + \boldsymbol{\varepsilon} \tag{5.2}$$

by least squares (or maximum likelihood). The divisor $y^{\lambda-1}$ turns out to be related to the **Jacobian** of the transformation converting the response variable y into $y^{(\lambda)}$. It is, in effect, a scale factor that ensures that residual sums of squares for models with different values of λ are comparable.

Computational Procedure The maximum-likelihood estimate of λ corresponds to the value of λ for which the residual sum of squares from the fitted model $SS_{\text{Res}}(\lambda)$ is a minimum. This value of λ is usually determined by fitting a model to $y^{(\lambda)}$ for various values of λ , plotting the residual sum of squares $SS_{\text{Res}}(\lambda)$ versus λ , and then reading the value of λ that minimizes $SS_{\text{Res}}(\lambda)$ from the graph. Usually 10–20 values of λ are sufficient for estimation of the optimum value. A second iteration can be performed using a finer mesh of values if desired. As noted above, we **cannot** select λ by **directly** comparing residual sums of squares from the regressions of y^λ on x because for each λ the residual sum of squares is measured on a different scale. Equation (5.1) scales the responses so that the residual sums of squares are directly comparable. We recommend that the analyst use simple choices for λ , as the practical difference in the fits for $\lambda = 0.5$ and $\lambda = 0.596$ is likely to be small, but the former is much easier to interpret.

Once a value of λ is selected, the analyst is now free to fit the model using y^λ as the response if $\lambda \neq 0$. If $\lambda = 0$, then use $\ln y$ as the response. It is entirely acceptable to use $y^{(\lambda)}$ as the response for the final model—this model will have a scale difference and an origin shift in comparison to the model using y^λ (or $\ln y$). In our experience, most engineers and scientists prefer using y^λ (or $\ln y$) as the response.

An Approximate Confidence Interval for λ We can also find an approximate CI for the transformation parameter λ . This CI can be useful in selecting the final value for λ ; for example, if $\hat{\lambda} = 0.596$ is the minimizing value for the residual sum of squares, but if $\lambda = 0.5$ is in the CI, then one might prefer to use the square-root transformation on the basis that it is easier to explain. Furthermore, if $\lambda = 1$ is in the CI, then no transformation may be necessary.

In applying the method of maximum likelihood to the regression model, we are essentially maximizing

$$L(\lambda) = -\frac{1}{2}n \ln[SS_{\text{Res}}(\lambda)] \quad (5.3)$$

or equivalently, we are minimizing the residual-sum-of-squares function $SS_{\text{Res}}(\lambda)$. An approximate $100(1 - \alpha)$ percent CI for λ consists of those values of λ that satisfy the inequality

$$L(\hat{\lambda}) - L(\lambda) \leq \frac{1}{2} \chi_{\alpha,1}^2 / n \quad (5.4)$$

where $\chi_{\alpha,1}^2$ is the upper α percentage point of the chi-square distribution with one degree of freedom. To actually construct the CI, we would draw, on a plot of $L(\lambda)$ versus λ a horizontal line at height

$$L(\hat{\lambda}) - \frac{1}{2} \chi_{\alpha,1}^2$$

on the vertical scale. This line would cut the curve of $L(\lambda)$ at two points, and the location of these two points on the λ axis defines the two end points of the approximate CI. If we are minimizing the residual sum of squares and plotting $SS_{\text{Res}}(\lambda)$ versus λ , then the line must be plotted at height

$$SS^* = SS_{\text{Res}}(\hat{\lambda})e^{\chi_{\alpha,1}^2/n} \quad (5.5)$$

Remember that $\hat{\lambda}$ is the value of λ that minimizes the residual sum of squares.

In actually applying the CI procedure, one is likely to find that the factor $\exp(\chi_{\alpha,1}^2/n)$ on the right-hand side of Eq. (5.5) is replaced by either $1 + z_{\alpha/2}^2/n$ or $1 + t_{\alpha/2,v}^2/n$ or $1 + \chi_{\alpha,1}^2/n$, or perhaps either $1 + z_{\alpha/2}^2/v$ or $1 + t_{\alpha/2,v}^2/v$ or $1 + \chi_{\alpha,1}^2/v$, where v is the number of residual degrees of freedom. These are based on the expansion of $\exp(x) = 1 + x + x^2/2! + x^3/3! + \dots = 1 + x$ and the fact that $\chi_1^2 = z^2 \approx t_v^2$ unless the number of residual degrees of freedom v is small. It is perhaps debatable whether we should use n or v , but in most practical cases, there will be very little difference between the CIs that result.

Example 5.3 The Electric Utility Data

Recall the electric utility data introduced in Example 5.1. We use the Box-Cox procedure to select a variance-stabilizing transformation. The values of $SS_{\text{Res}}(\lambda)$ for various values of λ are shown in Table 5.7. This display indicates that $\lambda = 0.5$ (the square-root transformation) is very close to the optimum value. Notice that we have used a finer “grid” on λ in the vicinity of the optimum. This is helpful in locating the optimum λ more precisely and in plotting the residual-sum-of-squares function.

A graph of the residual sum of squares versus λ is shown in Figure 5.9. If we take $\lambda = 0.5$ as the optimum value, then an approximate 95% CI for λ may be found by calculating the critical sum of squares SS^* from Eq. (5.5) as follows:

$$\begin{aligned} SS^* &= SS_{\text{Res}}(\hat{\lambda})e^{\chi_{0.05,1}^2/n} \\ &= 96.9495e^{3.84/53} \\ &= 96.9495(1.0751) \\ &= 104.23 \end{aligned}$$

The horizontal line at this height is shown in Figure 5.9. The corresponding values of $\lambda^- = 0.26$ and $\lambda^+ = 0.80$ read from the curve give the lower and upper confidence limits for λ , respectively. Since these limits do not include the value 1 (implying no transformation), we conclude that a transformation is helpful. Furthermore, the square-root transformation that was used in Example 5.1 has an analytic justification. ■

5.4.2 Transformations on the Regressor Variables

Suppose that the relationship between y and one or more of the regressor variables is nonlinear but that the usual assumptions of normally and independently distributed responses with constant variance are at least approximately satisfied. We want

TABLE 5.7 Values of the Residual Sum of Squares for Various Values of λ , Example 5.3

λ	$SS_{\text{Res}}(\lambda)$
-2	34,101.0381
-1	986.0423
-0.5	291.5834
0	134.0940
0.125	118.1982
0.25	107.2057
0.375	100.2561
0.5	96.9495
0.625	97.2889
0.75	101.6869
1	126.8660
2	1,275.5555

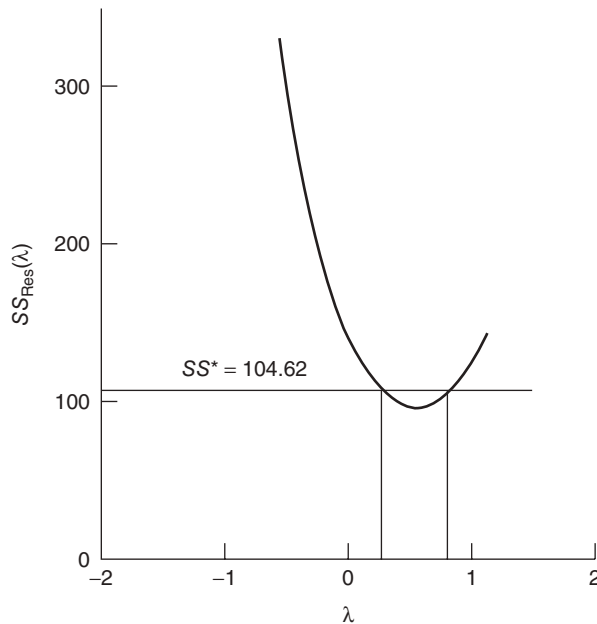
**Figure 5.9** Plot of residual sum of squares $SS_{\text{Res}}(\lambda)$ versus λ .

to select an appropriate transformation on the regressor variables so that the relationship between y and the transformed regressor is as simple as possible. Box and Tidwell [1962] describe an analytical procedure for determining the form of the transformation on x . While their procedure may be used in the general regression situation, we will present and illustrate its application to the simple linear regression model.

Assume that the response variable y is related to a power of the regressor, say $\xi = x^a$, as

$$E(y) = f(\xi, \beta_0, \beta_1) = \beta_0 + \beta_1 \xi$$

where

$$\xi = \begin{cases} x^\alpha, & a \neq 0 \\ \ln x & a = 0 \end{cases}$$

and $\beta_0, \beta_1,$ and α are unknown parameters. Suppose that α_0 is an initial guess of the constant α . Usually this first guess is $\alpha_0 = 1$, so that $\xi_0 = x^{\alpha_0} = x$, or that no transformation at all is applied in the first iteration. Expanding about the initial guess in a Taylor series and ignoring terms of higher than first order gives

$$\begin{aligned} E(y) &= f(\xi_0, \beta_0, \beta_1) + (\alpha - \alpha_0) \left\{ \frac{df(\xi, \beta_0, \beta_1)}{d\alpha} \right\}_{\substack{\xi=\xi_0 \\ \alpha=\alpha_0}} \\ &= \beta_0 + \beta_1 x + (\alpha - 1) \left\{ \frac{df(\xi, \beta_0, \beta_1)}{d\alpha} \right\}_{\substack{\xi=\xi_0 \\ \alpha=\alpha_0}} \end{aligned} \tag{5.6}$$

Now if the term in braces in Eq. (5.6) were known, it could be treated as an additional regressor variable, and it would be possible to estimate the parameters $\beta_0, \beta_1,$ and α in Eq. (5.6) by least squares. The estimate of α could be taken as an improved estimate of the transformation parameter. The term in braces in Eq. (5.6) can be written as

$$\left\{ \frac{df(\xi, \beta_0, \beta_1)}{d\alpha} \right\}_{\substack{\xi=\xi_0 \\ \alpha=\alpha_0}} = \left\{ \frac{df(\xi, \beta_0, \beta_1)}{d\xi} \right\}_{\xi=\xi_0} \left\{ \frac{d\xi}{d\alpha} \right\}_{\alpha=\alpha_0}$$

and since the form of the transformation is known, that is, $\xi = x^\alpha$, we have $d\xi/d\alpha = x \ln x$. Furthermore,

$$\left\{ \frac{df(\xi, \beta_0, \beta_1)}{d\xi} \right\}_{\xi=\xi_0} = \frac{d(\beta_0 + \beta_1 x)}{dx} = \beta_1$$

This parameter may be conveniently estimated by fitting the model

$$\hat{y} = \hat{\beta}_0 + \hat{\beta}_1 x \tag{5.7}$$

by least squares. Then an “adjustment” to the initial guess $\alpha_0 = 1$ may be computed by defining a second regressor variable as $w = x \ln x$, estimating the parameters in

$$E(y) = \beta_0^* + \beta_1^* x + (\alpha - 1) \beta_1 w = \beta_0^* + \beta_1^* x + \gamma w \tag{5.8}$$

by least squares, giving

$$\hat{y} = \hat{\beta}_0^* + \hat{\beta}_1^* x + \hat{\gamma} w \tag{5.9}$$

and taking

$$\alpha_1 = \frac{\hat{\gamma}}{\hat{\beta}_1} + 1 \quad (5.10)$$

as the revised estimate of α . Note that $\hat{\beta}_1$ is obtained from Eq. (5.7) and $\hat{\gamma}$ from Eq. (5.9); generally $\hat{\beta}_1$ and $\hat{\beta}_1^*$ will differ. This procedure may now be repeated using a new regressor $x' = x^{\alpha_1}$ in the calculations. Box and Tidwell [1962] note that this procedure usually converges quite rapidly, and often the first-stage result α is a satisfactory estimate of α . They also caution that round-off error is potentially a problem and successive values of α may oscillate wildly unless enough decimal places are carried. Convergence problems may be encountered in cases where the error standard deviation σ is large or when the range of the regressor is very small compared to its mean. This situation implies that the data do not support the need for any transformation.

Example 5.4 The Windmill Data

We will illustrate this procedure using the windmill data in Example 5.2. The scatter diagram in Figure 5.5 suggests that the relationship between DC output (y) and wind speed (x) is not a straight line and that some transformation on x may be appropriate.

We begin with the initial guess $\alpha_0 = 1$ and fit a straight-line model, giving $\hat{y} = 0.1309 + 0.2411x$. Then defining $w = x \ln x$, we fit Eq. (5.8) and obtain

$$\hat{y} = \hat{\beta}_0^* + \hat{\beta}_1^*x + \hat{\gamma}w = -2.4168 + 1.5344x - 0.4626w$$

From Eq. (5.10) we calculate

$$\alpha_1 = \frac{\hat{\gamma}}{\hat{\beta}_1} + 1 = \frac{-0.4626}{0.2411} + 1 = -0.92$$

as the improved estimate of α . Note that this estimate of α is very close to -1 , so that the reciprocal transformation on x actually used in Example 5.2 is supported by the Box-Tidwell procedure.

To perform a second iteration, we would define a new regressor variable $x' = x^{-0.92}$ and fit the model

$$\hat{y} = \hat{\beta}_0 + \hat{\beta}_1x' = 3.1039 - 6.6784x'$$

Then a second regressor $w' = x' \ln x'$ is formed and we fit

$$\hat{y} = \hat{\beta}_0^* + \hat{\beta}_1^*x' + \hat{\gamma}w' = 3.2409 - 6.445x' + 0.5994w'$$

The second-step estimate of α is thus

$$\alpha_2 = \frac{\hat{\gamma}}{\hat{\beta}_1} + \alpha_1 = \frac{0.5994}{-6.6784} + (-0.92) = -1.01$$

which again supports the use of the reciprocal transformation on x . ■

5.5 GENERALIZED AND WEIGHTED LEAST SQUARES

Linear regression models with nonconstant error variance can also be fitted by the method of **weighted least squares**. In this method of estimation the deviation between the observed and expected values of y_i is multiplied by a **weight** w_i chosen inversely proportional to the variance of y_i . For the case of simple linear regression, the weighted least-squares function is

$$S(\beta_0, \beta_1) = \sum_{i=1}^n w_i (y_i - \beta_0 - \beta_1 x_i)^2 \quad (5.11)$$

The resulting least-squares normal equations are

$$\begin{aligned} \hat{\beta}_0 \sum_{i=1}^n w_i + \hat{\beta}_1 \sum_{i=1}^n w_i x_i &= \sum_{i=1}^n w_i y_i \\ \beta_0 \sum_{i=1}^n w_i x_i + \hat{\beta}_1 \sum_{i=1}^n w_i x_i^2 &= \sum_{i=1}^n w_i x_i y_i \end{aligned} \quad (5.12)$$

Solving Eq. (5.12) will produce weighted least-squares estimates of β_0 and β_1 .

In this section we give a development of weighted least squares for the multiple regression model. We begin by considering a slightly more general situation concerning the structure of the model errors.

5.5.1 Generalized Least Squares

The assumptions usually made concerning the linear regression model $\mathbf{y} = \mathbf{X}\boldsymbol{\beta} + \boldsymbol{\varepsilon}$ are that $E(\boldsymbol{\varepsilon}) = \mathbf{0}$ and that $\text{Var}(\boldsymbol{\varepsilon}) = \sigma^2 \mathbf{I}$. As we have observed, sometimes these assumptions are unreasonable, so that we will now consider what modifications to these in the ordinary least-squares procedure are necessary when $\text{Var}(\boldsymbol{\varepsilon}) = \sigma^2 \mathbf{V}$, where \mathbf{V} is a known $n \times n$ matrix. This situation has an easy interpretation; if \mathbf{V} is diagonal but with unequal diagonal elements, then the observations \mathbf{y} are **uncorrelated** but have **unequal variances**, while if some of the off-diagonal elements of \mathbf{V} are nonzero, then the observations are **correlated**.

When the model is

$$\begin{aligned} \mathbf{y} &= \mathbf{X}\boldsymbol{\beta} + \boldsymbol{\varepsilon} \\ E(\boldsymbol{\varepsilon}) &= \mathbf{0}, \text{Var}(\boldsymbol{\varepsilon}) = \sigma^2 \mathbf{V} \end{aligned} \quad (5.13)$$

the ordinary least-squares estimator $\hat{\boldsymbol{\beta}} = (\mathbf{X}'\mathbf{X})^{-1} \mathbf{X}'\mathbf{y}$ is no longer appropriate. We will approach this problem by transforming the model to a new set of observations that satisfy the standard least-squares assumptions. Then we will use ordinary least squares on the transformed data. Since $\sigma^2 \mathbf{V}$ is the covariance matrix of the errors, \mathbf{V} must be nonsingular and positive definite, so there exists an $n \times n$ nonsingular symmetric matrix \mathbf{K} , where $\mathbf{K}'\mathbf{K} = \mathbf{K}\mathbf{K} = \mathbf{V}$. The matrix \mathbf{K} is often called the **square**

root of \mathbf{V} . Typically, σ^2 is unknown, in which case \mathbf{V} represents the assumed structure of the variances and covariances among the random errors apart from a constant.

Define the new variables

$$\mathbf{z} = \mathbf{K}^{-1}\mathbf{y}, \quad \mathbf{B} = \mathbf{K}^{-1}\mathbf{X}, \quad \mathbf{g} = \mathbf{K}^{-1}\boldsymbol{\varepsilon} \quad (5.14)$$

so that the regression model $\mathbf{y} = \mathbf{X}\boldsymbol{\beta} + \boldsymbol{\varepsilon}$ becomes $\mathbf{K}^{-1}\mathbf{y} = \mathbf{K}^{-1}\mathbf{X}\boldsymbol{\beta} + \mathbf{K}^{-1}\boldsymbol{\varepsilon}$, or

$$\mathbf{z} = \mathbf{B}\boldsymbol{\beta} + \mathbf{g} \quad (5.15)$$

The errors in this transformed model have zero expectation, that is, $E(\mathbf{g}) = \mathbf{K}^{-1}E(\boldsymbol{\varepsilon}) = \mathbf{0}$. Furthermore, the covariance matrix of \mathbf{g} is

$$\begin{aligned} \text{Var}(\mathbf{g}) &= \{[\mathbf{g} - E(\mathbf{g})][\mathbf{g} - E(\mathbf{g})]'\} \\ &= E(\mathbf{g}\mathbf{g}') \\ &= E(\mathbf{K}^{-1}\boldsymbol{\varepsilon}\boldsymbol{\varepsilon}'\mathbf{K}^{-1}) \\ &= \mathbf{K}^{-1}E(\boldsymbol{\varepsilon}\boldsymbol{\varepsilon}')\mathbf{K}^{-1} \\ &= \sigma^2\mathbf{K}^{-1}\mathbf{V}\mathbf{K}^{-1} \\ &= \sigma^2\mathbf{K}^{-1}\mathbf{K}\mathbf{K}^{-1} \\ &= \sigma^2\mathbf{I} \end{aligned} \quad (5.16)$$

Thus, the elements of \mathbf{g} have mean zero and constant variance and are uncorrelated. Since the errors \mathbf{g} in the model (5.15) satisfy the usual assumptions, we may apply ordinary least squares. The least-squares function is

$$S(\boldsymbol{\beta}) = \mathbf{g}'\mathbf{g} = \boldsymbol{\varepsilon}'\mathbf{V}^{-1}\boldsymbol{\varepsilon} = (\mathbf{y} - \mathbf{X}\boldsymbol{\beta})'\mathbf{V}^{-1}(\mathbf{y} - \mathbf{X}\boldsymbol{\beta}) \quad (5.17)$$

The least-squares normal equations are

$$(\mathbf{X}'\mathbf{V}^{-1}\mathbf{X})\hat{\boldsymbol{\beta}} = \mathbf{X}'\mathbf{V}^{-1}\mathbf{y} \quad (5.18)$$

and the solution to these equations is

$$\hat{\boldsymbol{\beta}} = (\mathbf{X}'\mathbf{V}^{-1}\mathbf{X})^{-1}\mathbf{X}'\mathbf{V}^{-1}\mathbf{y} \quad (5.19)$$

Here $\hat{\boldsymbol{\beta}}$ is called the **generalized least-squares estimator** of $\boldsymbol{\beta}$.

It is not difficult to show that $\hat{\boldsymbol{\beta}}$ is an unbiased estimator of $\boldsymbol{\beta}$. The covariance matrix of $\hat{\boldsymbol{\beta}}$ is

$$\text{Var}(\hat{\boldsymbol{\beta}}) = \sigma^2(\mathbf{B}'\mathbf{B})^{-1} = \sigma^2(\mathbf{X}'\mathbf{V}^{-1}\mathbf{X})^{-1} \quad (5.20)$$

Appendix C.11 shows that $\hat{\boldsymbol{\beta}}$ is the best linear unbiased estimator of $\boldsymbol{\beta}$. The analysis of variance in terms of generalized least squares is summarized in Table 5.8.

TABLE 5.8 Analysis of Variance for Generalized Least Squares

Source	Sum of Squares	Degrees of Freedom	Mean Square	F_0
Regression	$SS_R = \hat{\beta}'\mathbf{B}'\mathbf{z}$ $= \mathbf{y}'\mathbf{V}^{-1}\mathbf{X}(\mathbf{X}'\mathbf{V}^{-1}\mathbf{X})^{-1}\mathbf{X}'\mathbf{V}^{-1}\mathbf{y}$	p	SS_R/p	MS_R/MS_{Res}
Error	$SS_{Res} = \mathbf{z}'\mathbf{z} - \hat{\beta}'\mathbf{B}'\mathbf{z}$ $= \mathbf{y}'\mathbf{V}^{-1}\mathbf{y}$ $- \mathbf{y}'\mathbf{V}^{-1}\mathbf{X}(\mathbf{X}'\mathbf{V}^{-1}\mathbf{X})^{-1}\mathbf{X}'\mathbf{V}^{-1}\mathbf{y}$	$n - p$	$SS_{Res}/(n - p)$	
Total	$\mathbf{z}'\mathbf{z} = \mathbf{y}'\mathbf{V}^{-1}\mathbf{y}$	n		

5.5.2 Weighted Least Squares

When the errors $\boldsymbol{\varepsilon}$ are uncorrelated but have unequal variances so that the covariance matrix of $\boldsymbol{\varepsilon}$ is

$$\sigma^2\mathbf{V} = \sigma^2 \begin{bmatrix} \frac{1}{w_1} & & & 0 \\ & \frac{1}{w_2} & & \\ & & \ddots & \\ 0 & & & \frac{1}{w_n} \end{bmatrix}$$

say, the estimation procedure is usually called **weighted least squares**. Let $\mathbf{W} = \mathbf{V}^{-1}$. Since \mathbf{V} is a diagonal matrix, \mathbf{W} is also diagonal with diagonal elements or **weights** w_1, w_2, \dots, w_n . From Eq. (5.18), the weighted least-squares normal equations are

$$(\mathbf{X}'\mathbf{W}\mathbf{X})\hat{\boldsymbol{\beta}} = \mathbf{X}'\mathbf{W}\mathbf{y}$$

This is the multiple regression analogue of the weighted least-squares normal equations for simple linear regression given in Eq. (5.12). Therefore,

$$\hat{\boldsymbol{\beta}} = (\mathbf{X}'\mathbf{W}\mathbf{X})^{-1}\mathbf{X}'\mathbf{W}\mathbf{y}$$

is the **weighted least-squares estimator**. Note that observations with large variances will have smaller weights than observations with small variances.

Weighted least-squares estimates may be obtained easily from an ordinary least-squares computer program. If we multiply each of the observed values for the i th observation (including the 1 for the intercept) by the square root of the weight for that observation, then we obtain a transformed set of data:

$$\mathbf{B} = \begin{bmatrix} 1\sqrt{w_1} & x_{11}\sqrt{w_1} & \cdots & x_{1k}\sqrt{w_1} \\ 1\sqrt{w_2} & x_{21}\sqrt{w_2} & \cdots & x_{2k}\sqrt{w_2} \\ \vdots & \vdots & & \vdots \\ 1\sqrt{w_n} & x_{n1}\sqrt{w_n} & \cdots & x_{nk}\sqrt{w_n} \end{bmatrix}, \quad \mathbf{z} = \begin{bmatrix} y_1\sqrt{w_1} \\ y_2\sqrt{w_2} \\ \vdots \\ y_n\sqrt{w_n} \end{bmatrix}$$

Now if we apply ordinary least squares to these transformed data, we obtain

$$\hat{\boldsymbol{\beta}} = (\mathbf{B}'\mathbf{B})^{-1} \mathbf{B}'\mathbf{z} = (\mathbf{X}'\mathbf{W}\mathbf{X})^{-1} \mathbf{X}'\mathbf{W}\mathbf{y}$$

the weighted least-squares estimate of $\boldsymbol{\beta}$.

Both JMP and Minitab will perform weighted least squares. SAS will do weighted least squares. The user must specify a “weight” variable, for example, w . To perform weighted least squares, the user adds the following statement after the model statement:

```
weight w;
```

5.5.3 Some Practical Issues

To use weighted least squares, the weights w_i must be known. Sometimes prior knowledge or experience or information from a theoretical model can be used to determine the weights (for an example of this approach, see Weisberg [1985]). Alternatively, residual analysis may indicate that the variance of the errors may be a function of one of the regressors, say $\text{Var}(\varepsilon_i) = \sigma^2 x_{ij}$, so that $w_i = 1/x_{ij}$. In some cases y_i is actually an average of n_i observations at x_i and if all **original** observations have constant variance σ^2 , then the variance of y_i is $\text{Var}(y_i) = \text{Var}(\varepsilon_i) = \sigma^2/n_i$, and we would choose the weights as $w_i = n_i$. Sometimes the primary source of error is measurement error and different observations are measured by different instruments of unequal but known (or well-estimated) accuracy. Then the weights could be chosen inversely proportional to the variances of measurement error. In many practical cases we may have to guess at the weights, perform the analysis, and then reestimate the weights based on the results. Several iterations may be necessary.

Since generalized or weighted least squares requires making additional assumptions regarding the errors, it is of interest to ask what happens when we fail to do this and use ordinary least squares in a situation where $\text{Var}(\boldsymbol{\varepsilon}) = \sigma^2 \mathbf{V}$ with $\mathbf{V} \neq \mathbf{I}$. If ordinary least squares is used in this case, the resulting estimator $\hat{\boldsymbol{\beta}} = (\mathbf{X}'\mathbf{X})^{-1} \mathbf{X}'\mathbf{y}$ is still unbiased. However, the ordinary least-squares estimator is no longer a minimum-variance estimator. That is, the covariance matrix of the ordinary least-squares estimator is

$$\text{Var}(\hat{\boldsymbol{\beta}}) = \sigma^2 (\mathbf{X}'\mathbf{X})^{-1} \mathbf{X}'\mathbf{V}\mathbf{X}(\mathbf{X}'\mathbf{X})^{-1} \quad (5.21)$$

and the covariance matrix of the generalized least-squares estimator (5.20) gives smaller variances for the regression coefficients. Thus, generalized or weighted least squares is preferable to ordinary least squares whenever $\mathbf{V} \neq \mathbf{I}$.

Example 5.5 Weighted Least Squares

The average monthly income from food sales and the corresponding annual advertising expenses for 30 restaurants are shown in columns a and b of Table 5.9. Management is interested in the relationship between these variables, and so a linear regression model relating food sales y to advertising expense x is fit by ordinary least squares, resulting in $\hat{y} = 49,443.3838 + 8.0484x$. The residuals from this

TABLE 5.9 Restaurant Food Sales Data

Obs. i	(a) Income, Y_i	(b) Advertising Expense, X_i	(c) \bar{x}	(d) s_y^2	(e) Weights, w_i
1	81,464	3,000	3,078.3	26,794,616	6.21771 $E-08$
2	72,661	3,150			5.79507 $E-08$
3	72,344	3,085			5.97094 $E-08$
4	90,743	5,225	5,287.5	30,772,013	2.98667 $E-08$
5	98,588	5,350			2.90195 $E-08$
6	96,507	6,090			2.48471 $E-08$
7	126,574	8,925	8,955.0	52,803,695	1.60217 $E-08$
8	114,133	9,015			1.58431 $E-08$
9	115,814	8,885			1.61024 $E-08$
10	123,181	8,950			1.59717 $E-08$
11	131,434	9,000			1.58726 $E-08$
12	140,564	1,1345			12,171.0
13	151,352	12,275	1.12852 $E-08$		
14	146,926	12,400	1.11621 $E-08$		
15	130,963	12,525	1.10416 $E-08$		
16	144,630	12,310	1.12505 $E-08$		
17	147,041	13,700	1.00246 $E-08$		
18	179,021	15,000	15,095.0	120,571,061	
19	166,200	15,175			8.98563 $E-09$
20	180,732	14,995			9.10073 $E-09$
21	178,187	15,050			9.06525 $E-09$
22	185,304	15,200			8.96987 $E-09$
23	155,931	15,150			9.00144 $E-09$
24	172,579	16,800	16,650.0	132,388,992	8.06478 $E-09$
25	188,851	16,500			8.22030 $E-09$
26	192,424	17,830			7.57287 $E-09$
27	203,112	19,500	19,262.5	138,856,871	6.89136 $E-09$
28	192,482	19,200			7.00460 $E-09$
29	218,715	19,000			7.08218 $E-09$
30	214,317	19,350			6.94752 $E-09$

least-squares fit are plotted against \hat{y}_i in Figure 5.10. This plot indicates violation of the constant-variance assumption. Consequently, the ordinary least-squares fit is inappropriate.

To correct this inequality-of-variance problem, we must know the weights w_i . We note from examining the data in Table 5.9 that there are several sets of x values that are “near neighbors,” that is, that have approximate repeat points on x . We will assume that these near neighbors are close enough to be considered repeat points and use the variance of the responses at those repeat points to investigate how $\text{Var}(y)$ changes with x . Columns c and d of Table 5.9 show the average x value (\bar{x}) for each cluster of near neighbors and the sample variance of the y 's in each cluster. Plotting s_y^2 against the corresponding \bar{x} implies that s_y^2 increases approximately linearly with \bar{x} . A least-squares fit gives

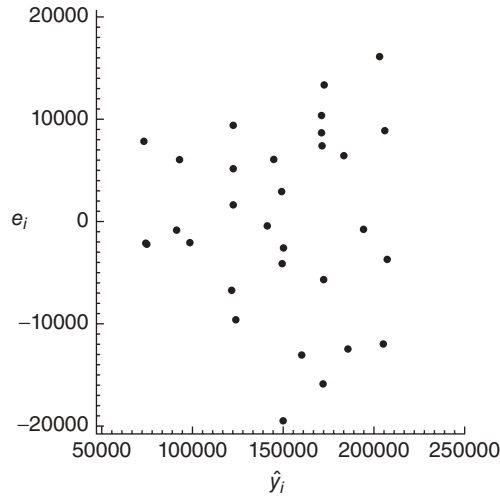

Figure 5.10 Plot of ordinary least-squares residuals versus fitted values, Example 5.5.

$$\hat{s}_y^2 = -9,226,002 + 7781.626\bar{x}$$

Substituting each x_i value into this equation will give an estimate of the variance of the corresponding observation y_i . The inverse of these fitted values will be reasonable estimates of the weights w_i . These estimated weights are shown in column e of Table 5.9.

Applying weighted least squares to the data using the weights in Table 5.9 gives the fitted model

$$\hat{y} = 50,974.564 + 7.92224x$$

We must now examine the residuals to determine if using weighted least squares has improved the fit. To do this, plot the **weighted** residuals $w_i^{1/2}e_i = w_i^{1/2}(y_i - \hat{y}_i)$, where \hat{y}_i comes from the weighted least-squares fit, against $w_i^{1/2}\hat{y}_i$. This plot is shown in Figure 5.11 and is much improved when compared to the previous plot for the ordinary least-squares fit. We conclude that weighted least squares has corrected the inequality-of-variance problem.

Two other points concerning this example should be made. First, we were fortunate to have several near neighbors in the x space. Furthermore, it was easy to identify these clusters of points by inspection of Table 5.9 because there was only one regressor involved. With several regressors visual identification of these clusters would be more difficult. Recall that an analytical procedure for finding pairs of points that are close together in x space was presented in Section 4.5.3. The second point involves the use of a regression equation to estimate the weights. The analyst should carefully check the weights produced by the equation to be sure that they are reasonable. For example, in our problem a sufficiently small x value could result in a negative weight, which is clearly unreasonable. ■

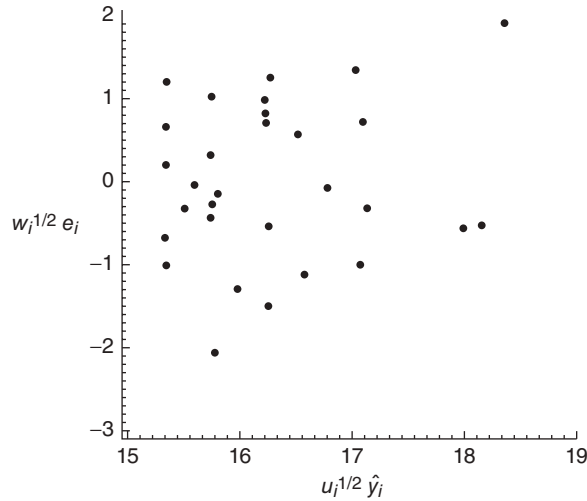

Figure 5.11 Plot of weighted residuals $w_i^{1/2}e_i$ versus weighted fitted values $w_i^{1/2}\hat{y}_i$, Example 5.5.

5.6 REGRESSION MODELS WITH RANDOM EFFECTS

5.6.1 Subsampling

Random effects allow the analyst to take into account multiple sources of variability. For example, many people use simple paper helicopters to illustrate some of the basic principles of experimental design. Consider a simple experiment to determine the effect of the length of the helicopter’s wings to the typical flight time. There often is quite a bit of error associated with measuring the time for a specific flight of a helicopter, especially when the people who are timing the flights have never done this before. As a result, a popular protocol for this experiment has three people timing each flight to get a more accurate idea of its actual flight time. In addition, there is quite a bit of variability from helicopter to helicopter, particularly in a corporate short course where the students have never made these helicopters before. This particular experiment thus has two sources of variability: within each specific helicopter and between the various helicopters used in the study.

A reasonable model for this experiment is

$$y_{ij} = \beta_0 + \beta_1 x_i + \delta_i + \varepsilon_{ij} \quad (i = 1, 2, \dots, m \text{ and } j = 1, 2, \dots, r_i) \quad (5.22)$$

where m is the number of helicopters, r_i is the number of measured flight times for the i^{th} helicopter, y_{ij} is the flight time for the j^{th} flight of the i^{th} helicopter, x_i is the length of the wings for the i^{th} helicopter, δ_i is the error term associated with the i^{th} helicopter, and ε_{ij} is the random error associated with the j^{th} flight of the i^{th} helicopter. The key point is that there are two sources of variability represented by δ_i and ε_{ij} . Typically, we would assume that the δ_i s are independent and normally distributed with a mean of 0 and a constant variance σ_δ^2 , that the ε_{ij} s are independent and normally distributed with mean 0 and constant variance σ^2 , and that the δ_i s and the ε_{ij} s

are independent. Under these assumptions, the flight times for a specific helicopter are correlated. The flight times across helicopters are independent.

Equation (5.22) is an example of a **mixed model** that contains **fixed effects**, in this case the x_i s, and **random effects**, in this case the δ_j s and the ε_{ij} s. The units used for a specific random effect represent a random sample from a much larger population of possible units. For example, patients in a biomedical study often are random effects. The analyst selects the patients for the study from a large population of possible people. The focus of all statistical inference is not on the specific patients selected; rather, the focus is on the population of all possible patients. The key point underlying all random effects is this focus on the population and not on the specific units selected for the study. Random effects almost always are categorical.

The data collection method creates the need for the mixed model. In some sense, our standard regression model $\mathbf{y} = \mathbf{X}\boldsymbol{\beta} + \boldsymbol{\varepsilon}$ is a mixed model with $\boldsymbol{\beta}$ representing the fixed effects and $\boldsymbol{\varepsilon}$ representing the random effects. More typically, we restrict the term mixed model to the situations where we have more than one error term.

Equation (5.22) is the standard model when we have multiple observations on a single unit. Often we call such a situation subsampling. The experimental protocol creates the need for two separate error terms. In most biomedical studies we have several observations for each patient. Once again, our protocol creates the need for two error terms: one for the observation-to-observation differences within a patient and another error term to explain the randomly selected patient-to-patient differences.

In the subsampling situation, the total number of observations in the study, $n = \sum_{i=1}^m r_i$. Equation (5.22) in matrix form is

$$\mathbf{y} = \mathbf{X}\boldsymbol{\beta} + \mathbf{Z}\boldsymbol{\delta} + \boldsymbol{\varepsilon}$$

where \mathbf{Z} is a $n \times m$ “incidence” matrix and $\boldsymbol{\delta}$ is a $m \times 1$ vector of random helicopter-to-helicopter errors. The form of \mathbf{Z} is

$$\mathbf{Z} = \begin{bmatrix} \mathbf{1}_{r_1} & \mathbf{0} & \dots & \mathbf{0} \\ \mathbf{0} & \mathbf{1}_{r_2} & \dots & \mathbf{0} \\ \vdots & \vdots & \vdots & \vdots \\ \mathbf{0} & \mathbf{0} & \dots & \mathbf{1}_{r_m} \end{bmatrix}$$

where $\mathbf{1}_i$ is a $r_i \times 1$ vector of ones. We can establish that

$$\text{Var}(\mathbf{y}) = \sigma^2 \mathbf{I} + \sigma_\delta^2 \mathbf{Z}\mathbf{Z}'.$$

The matrix $\mathbf{Z}\mathbf{Z}'$ is block diagonal with each block consisting of a $r_i \times r_i$ matrix of ones. The net consequence of this model is that one should use generalized least squares to estimate $\boldsymbol{\beta}$. In the case that we have balanced data, where there are the same number of observations per helicopter, then the ordinary least squares estimate of $\boldsymbol{\beta}$ is exactly the same as the generalized least squares estimate and is the best linear unbiased estimate. As a result, ordinary least squares is an excellent way to estimate the model. However, there are serious issues with any inference based on the usual ordinary least squares methodology because it does not reflect the

helicopter-to-helicopter variability. This important source of error is missing from the usual ordinary least squares analysis. Thus, while it is appropriate to use ordinary least squares to estimate the model, it is not appropriate to do the standard ordinary least squares inference on the model based on the original flight times. To do so would be to ignore the impact of the helicopter-to-helicopter error term. In the balanced case and only in the balanced case, we can construct exact F and t tests. It can be shown (see Exercise 5.19) that the appropriate error term is based on

$$SS_{\text{subsample}} = \mathbf{y}' [\mathbf{Z}(\mathbf{Z}'\mathbf{Z})^{-1}\mathbf{Z}' - \mathbf{X}(\mathbf{X}'\mathbf{X})^{-1}\mathbf{X}'] \mathbf{y},$$

which has $m - p$ degrees of freedom. Basically, this error term uses the average flight times for each helicopter rather than the individual flight times. As a result, the generalized least squares analysis is exactly equivalent to doing an ordinary least squares analysis on the average flight time for each helicopter. This insight is important when using the software, as we illustrate in the next example.

If we do not have balance, then we recommend residual maximum likelihood, also known as restricted maximum likelihood (REML) as the basis for estimation and inference (see Section 5.6.2). In the unbalanced situation there are no best linear unbiased estimates of β . The inference based on REML is asymptotically efficient.

Example 5.6 The Helicopter Subsampling Study

Table 5.10 summarizes data from an industrial short course on experimental design that used the paper helicopter as a class exercise. The class conducted a simple 2^2 factorial experiment replicated a total of twice. As a result, the experiment required a total of eight helicopters to see the effect of “aspect,” which was the length of the body of a paper helicopter, and “paper,” which was the weight of the paper, on the flight time. Three people timed the each helicopter flight, which yields three flight times for each flight. The variable Rep is necessary to do the proper analysis on the original flight times. The table gives the data in the actual run order.

The Minitab analysis of the original flight times requires three steps. First, we can do the ordinary least squares estimation of the model to get the estimates of the model coefficients. Next, we need to re-analyze the data to get the estimate of the proper error variance. The final step requires us to update the t statistics from the first step to reflect the proper error term.

Table 5.11 gives the analysis for the first step. The estimated model is correct. However, the R^2 , the t statistics, the F statistics and their associated P values are all incorrect because they do not reflect the proper error term.

The second step creates the proper error term. In so doing, we must use the General Linear Model functionality within Minitab. Basically, we treat the factors and their interaction as categorical. The model statement to generate the correct error term is:

```
aspect paper aspect*paper rep(aspect paper)
```

One then must list rep as a random factor. Table 5.12 gives the results. The proper error term is the mean squared for rep(aspect paper).

TABLE 5.10 The Helicopter Subsampling Data

Helicopter	Aspect	Paper	Interaction	Rep	Time
1	1	-1	-1	1	3.60
1	1	-1	-1	1	3.85
1	1	-1	-1	1	3.98
2	-1	-1	1	1	6.44
2	-1	-1	1	1	6.37
2	-1	-1	1	1	6.78
3	-1	1	-1	1	6.84
3	-1	1	-1	1	6.90
3	-1	1	-1	1	7.18
4	-1	1	-1	2	6.37
4	-1	1	-1	2	6.38
4	-1	1	-1	2	6.58
5	1	1	1	1	3.44
5	1	1	1	1	3.43
5	1	1	1	1	3.75
6	1	-1	-1	2	3.75
6	1	-1	-1	2	3.73
6	1	-1	-1	2	4.10
7	1	1	1	2	4.59
7	1	1	1	2	4.64
7	1	1	1	2	5.02
8	-1	-1	1	2	6.50
8	-1	-1	1	2	6.33
8	-1	-1	1	2	6.92

TABLE 5.11 Minitab Analysis for the First Step of the Helicopter Subsampling Data

The regression equation is

$$\text{time} = 5.31 - 1.32 \text{ aspect} + 0.115 \text{ paper} + 0.0396 \text{ inter}$$

Predictor	Coef	SE Coef	T	P
Constant	5.31125	0.08339	63.69	0.000
aspect	-1.32125	0.08339	-15.84	0.000
paper	0.11542	0.08339	1.38	0.182
inter	0.03958	0.08339	0.47	0.640

S = 0.408541 R-Sq = 92.7% R-Sq(adj) = 91.6%

Analysis of Variance

Source	DF	SS	MS	F	P
Regression	3	42.254	14.085	84.39	0.000
Residual	20	3.338	0.167		
Error					
Total	23	45.592			

TABLE 5.12 Minitab Analysis for the Second Step of the Helicopter Subsampling Data

Analysis of Variance for time, using Adjusted SS for Tests						
Source	DF	Seq SS	Adj SS	Adj MS	F	P
aspect	1	41.8968	41.8968	41.8968	63.83	0.001
paper	1	0.3197	0.3197	0.3197	0.49	0.524
aspect*paper	1	0.0376	0.0376	0.0376	0.06	0.823
rep(aspect paper)	4	2.6255	2.6255	0.6564	14.74	0.000
Error	16	0.7126	0.7126	0.0445		
Total	23	45.5923				

S = 0.211039 R-Sq = 98.44% R-Sq(adj) = 97.75%

The third step is to correct the t statistics from the first step. The mean squared residual from the first step is 0.167. The correct error variance is 0.6564. Both of these values are rounded, which is all right, but it will lead to small differences when we do a correct one-step procedure based on the average flight times. Let t_j be the t -statistic for the first-step analysis for the j^{th} estimated coefficient, and let $t_{c,j}$ be the corrected statistic given by

$$t_{c,j} = \sqrt{\frac{0.167}{0.6564}} t_j.$$

These t statistics have the degrees of freedom associated with rep(aspect paper), which in this case is 4. Table 5.13 gives the correct t statistics and P values. We note that the correct t statistics are smaller in absolute value than for the first-step analysis. This result reflects the fact that the error variance in the first step is too small since it ignores the helicopter-to-helicopter variability. The basic conclusion is that aspect seems to be the only important factor, which is true in both the first-step analysis and the correct analysis. It is important to note, however, that this equivalence does not hold in general. *Regressors that appear important in the first-step analysis often are not statistically significant in the correct analysis.*

An easier way to do this analysis in Minitab recognizes that we do have a balanced situation here because we have exactly three times for each helicopter's flight. As a result, we can do the proper analysis using the average time for each helicopter flight. Table 5.14 summarizes the data. Table 5.15 gives the analysis from Minitab, which apart from rounding reflects the same values as Table 5.12. We can do a full residual analysis of these data, which we leave as an exercise for the reader. ■

5.6.2 The General Situation for a Regression Model with a Single Random Effect

The balanced subsampling problem discussed in Section 5.6.1 is common. This section extends these ideas to the more general situation when there is a single random effect in our regression model.

For example, suppose an environmental engineer postulates that the amount of a particular pollutant in lakes across the Commonwealth of Virginia depends upon the water temperature. She takes water samples from various randomly selected

TABLE 5.13 Correct *t* Statistics and *P* Values for the Helicopter Subsampling Data

Factor	<i>t</i>	<i>P</i> Value
Constant	32.12515	0.000
aspect	-7.98968	0.001
paper	0.60607	0.525
Aspect*paper	0.237067	0.824

TABLE 5.14 Average Flight Times for the Helicopter Subsampling Data

Helicopter	Aspect	Paper	Interaction	Average Time
1	1	-1	-1	3.810
2	-1	-1	1	6.530
3	-1	1	-1	6.973
4	-1	1	-1	6.443
5	1	1	1	3.540
6	1	-1	-1	3.860
7	1	1	1	4.750
8	-1	-1	1	6.583

TABLE 5.15 Final Minitab Analysis for the Helicopter Experiment in Table 5.14

The regression equation is
 Average Time = 5.31 - 1.32 Aspect + 0.115 Paper + 0.040 Aspect*Paper

Predictor	Coef	SE Coef	T	P
Constant	5.3111	0.1654	32.12	0.000
Aspect	-1.3211	0.1654	-7.99	0.001
Paper	0.1154	0.1654	0.70	0.524
Aspect*Paper	0.0396	0.1654	0.24	0.822

S = 0.467748 R-Sq = 94.1% R-Sq(adj) = 89.8%

Analysis of Variance					
Source	DF	SS	MS	F	P
Regression	3	14.0820	4.6940	21.45	0.006
Residual Error	4	0.8752	0.2188		
Total	7	14.9572			

locations for several randomly selected lakes in Virginia. She records the water temperature at the time of the sample was taken. She then sends the water sample to her laboratory to determine the amount of the particular pollutant present. There are two sources of variability: location-to-location within a lake and lake-to-lake. This point is important. A heavily polluted lake is likely to have much higher amount of the pollutant across all of its locations than a lightly polluted lake.

The model given by Equation (5.22) provides a basis for analyzing these data. The water temperature is a fixed regressor. There are two components to the

variability in the data: the random lake effect and the random location within the lake effect. Let σ^2 be the variance of the location random effect, and let σ_δ^2 be the variance of the lake random effect.

Although we can use the same model for this lake pollution example as the subsampling experiment, the experimental contexts are very different. In the helicopter experiment, the helicopter is the fundamental experimental unit, which is the smallest unit to which we can apply the treatment. However, we realize that there is a great deal of variability in the flight times for a specific helicopter. Thus, flying the helicopter several times gives us a better idea about the typical flying time for that specific helicopter. The experimental error looks at the variability among the experimental units. The variability in the flying times for a specific helicopter is part of the experimental error, but it is only a part. Another component is the variability in trying to replicate precisely the levels for the experimental factors. In the subsampling case, it is pretty easy to ensure that the number of subsamples (in the helicopter case, the flights) is the same, which leads to the balanced case.

In the lake pollution case, we have a true observational study. The engineer is taking a single water sample at each location. She probably uses fewer randomly selected locations for smaller lakes, and more randomly selected lakes from larger lakes. In addition, it is not practical for her to sample from every lake in Virginia. On the other hand, it is very straightforward for her to select randomly a series of lakes for testing. As a result, we expect to have different number of locations for each lake; hence, we expect to see an unbalanced situation.

We recommend the use of REML for the unbalanced case. REML is a very general method for analysis of statistical models with random effects represented by the model terms δ_i and ε_{ij} in Equation (5.22). Many software packages use REML to estimate the variance components associated with the random effects in mixed models like the model for the paper helicopter experiment. REML then uses an iterative procedure to pursue a weighted least squares approach for estimating the model. Ultimately, REML uses the estimated variance components to perform statistical tests and construct confidence intervals for the final estimated model.

REML operates by dividing the parameter estimation problem into two parts. In the first stage the random effects are ignored and the fixed effects are estimated, usually by ordinary least squares. Then a set of residuals from the model is constructed and the likelihood function for these residuals is obtained. In the second stage the maximum likelihood estimates for the variance components are obtained by maximizing the likelihood function for the residuals. The procedure then takes the estimated variance components to produce an estimate of the variance of y , which it then uses to reestimate the fixed effects. It then updates the residuals and the estimates of the variance components. The procedure continues to some convergence criterion. REML always assumes that the observations are normally distributed because this simplifies setting up the likelihood function.

REML estimates have all the properties of maximum likelihood. As a result, they are asymptotically unbiased and minimum variance. There are several ways to determine the degrees of freedom for the maximum likelihood estimates in REML, and some controversy about the best way to do this, but a full discussion of these issues is beyond the scope of this book. The following example illustrates the use of REML for a mixed effects regression model.

Parameter Estimates						
Term	Estimate	Std Error	DFDen	t Ratio	Prob> t	
Intercept	2.0754319	1.356914	6.667	1.53	0.1721	
cases	1.7148234	0.1868	21.97	9.18	<.0001*	
dist	0.0120317	0.003797	21.9	3.17	0.0045*	

REML Variance Component Estimates						
Random Effect	Var	Component	Std Error	95% Lower	95% Upper	Pct of Total
city	0.2946232	2.5897428	3.4964817	-4.263235	9.442721	22.757
Residual		8.7900161	2.8169566	5.1131327	18.546137	77.243
Total		11.379759				100.000

-2 LogLikelihood = 136.68398351

Figure 5.12 JMP results for the delivery time data treating city as a random effects.

Example 5.7 The Delivery Time Data Revisited

We introduced the delivery time data in Example 3.1. In Section 4.2.6 we observed that the first seven observations were collected from San Diego, observations 8–17 from Boston, observations 18–23 from Austin, and observations 24 and 25 from Minneapolis.

It is not unreasonable to assume that the cities used in this study represent a random sample of cities across the country. Ultimately, our interest is the impact of the number of cases delivered and the distance required to make the delivery on the delivery times over the entire country. As a result, a proper analysis needs to consider the impact of the random city effect on this analysis.

Figure 5.12 summarizes the analysis from JMP. We see few differences in the parameter estimates between the mixed model analysis that did not include the city's factor, given in Example 3.1. The P values for cases and distance are larger but only slightly so. The intercept P value is quite a bit larger. Part of this change is due to the significant decrease in the effective degrees of freedom for the intercept effect as the result of using the city information. The plot of the actual delivery times versus the predicted shows that the model is reasonable. The variance component for city is approximately 2.59. The variance for the residual error is 8.79. In the original analysis of Example 3.1 is 10.6. Clearly, part of the variability from the Example 3.1 analysis considered purely random is due to systematic variability due to the various cities, which the REML reflects through the cities' variance component.

The SAS code to analyze these data is:

```
proc mixed cl;
  class city;
  model time = cases distance / ddfm=kenwardroger s;
  random city;
run;
```

The following R code assumes that the data are in the object `deliver`. Also, one must load the package `nlme` in order to perform this analysis.

```
deliver.model <- lme(time~cases+dist, random=~1|city,
data=deliver) print(deliver.model)
```

R reports the estimated standard deviations rather than the variances. As a result, one needs to square the estimates to get the same results as SAS and JMP. ■

5.6.3 The Importance of the Mixed Model in Regression

Classical regression analysis always has assumed that there is only one source of variability. However, the analysis of many important experimental designs often has required the use of multiple sources of variability. Consequently, analysts have been using mixed models for many years to analyze experimental data. However, in such cases, the investigator typically planned a balanced experiment, which made for a straightforward analysis. REML evolved as a way to deal with imbalance primarily for the analysis of variance (ANOVA) models that underlie the classical analysis of experimental designs.

Recently, regression analysts have come to understand that there often are multiple sources of error in their observational studies. They have realized that classical regression analysis falls short in taking these multiple error terms in the analysis. They have realized that the result often is the use of an error term that understates the proper variability. The resulting analyses have tended to identify more significant factors than the data truly justifies.

We intend this section to be a short introduction to the mixed model in regression analysis. It is quite straightforward to extend what we have done here to more complex mixed models with more error terms. We hope that this presentation will help readers to appreciate the need for mixed models and to see how to modify the classical regression model and analysis to accommodate more complex error structures. The modification requires the use of generalized least squares; however, it is not difficult to do.

PROBLEMS

- 5.1** Byers and Williams (“Viscosities of Binary and Ternary Mixtures of Polyaromatic Hydrocarbons,” *Journal of Chemical and Engineering Data*, **32**, 349–354, 1987) studied the impact of temperature (the regressor) on the viscosity (the response) of toluene-tetralin blends. The following table gives the data for blends with a 0.4 molar fraction of toluene.

Temperature (°C)	Viscosity (mPa · s)
24.9	1.133
35.0	0.9772
44.9	0.8532
55.1	0.7550
65.2	0.6723
75.2	0.6021
85.2	0.5420
95.2	0.5074

- a. Plot a scatter diagram. Does it seem likely that a straight-line model will be adequate?
- b. Fit the straight-line model. Compute the summary statistics and the residual plots. What are your conclusions regarding model adequacy?
- c. Basic principles of physical chemistry suggest that the viscosity is an exponential function of the temperature. Repeat part b using the appropriate transformation based on this information.

5.2 The following table gives the vapor pressure of water for various temperatures.

Temperature (°K)	Vapor Pressure (mm Hg)
273	4.6
283	9.2
293	17.5
303	31.8
313	55.3
323	92.5
333	149.4
343	233.7
353	355.1
363	525.8
373	760.0

- a. Plot a scatter diagram. Does it seem likely that a straight-line model will be adequate?
- b. Fit the straight-line model. Compute the summary statistics and the residual plots. What are your conclusions regarding model adequacy?
- c. From physical chemistry the Clausius-Clapeyron equation states that

$$\ln(p_v) \propto -\frac{1}{T}$$

Repeat part b using the appropriate transformation based on this information.

5.3 The data shown below present the average number of surviving bacteria in a canned food product and the minutes of exposure to 300°F heat.

Number of Bacteria	Minutes of Exposure
175	1
108	2
95	3
82	4
71	5
50	6

(Continued)

Number of Bacteria	Minutes of Exposure
49	7
31	8
28	9
17	10
16	11
11	12

- Plot a scatter diagram. Does it seem likely that a straight-line model will be adequate?
- Fit the straight-line model. Compute the summary statistics and the residual plots. What are your conclusions regarding model adequacy?
- Identify an appropriate transformed model for these data. Fit this model to the data and conduct the usual tests of model adequacy.

- 5.4** Consider the data shown below. Construct a scatter diagram and suggest an appropriate form for the regression model. Fit this model to the data and conduct the standard tests of model adequacy.

x	10	15	18	12	9	8	11	6
y	0.17	0.13	0.09	0.15	0.20	0.21	0.18	0.24

- 5.5** A glass bottle manufacturing company has recorded data on the average number of defects per 10,000 bottles due to stones (small pieces of rock embedded in the bottle wall) and the number of weeks since the last furnace overhaul. The data are shown below.

Defects per 10,000	Weeks	Defects per 10,000	Weeks
13.0	4	34.2	11
16.1	5	65.6	12
14.5	6	49.2	13
17.8	7	66.2	14
22.0	8	81.2	15
27.4	9	87.4	16
16.8	10	114.5	17

- Fit a straight-line regression model to the data and perform the standard tests for model adequacy.
 - Suggest an appropriate transformation to eliminate the problems encountered in part a. Fit the transformed model and check for adequacy.
- 5.6** Consider the fuel consumption data in Table B.18. For the purposes of this exercise, ignore regressor x_1 . Recall the thorough residual analysis of these data from Exercise 4.27. Would a transformation improve this analysis? Why or why not? If yes, perform the transformation and repeat the full analysis.

- 5.7** Consider the methanol oxidation data in Table B.20. Perform a thorough analysis of these data. Recall the thorough residual analysis of these data from Exercise 4.29. Would a transformation improve this analysis? Why or why not? If yes, perform the transformation and repeat the full analysis.
- 5.8** Consider the three models
- a. $y = \beta_0 + \beta_1(1/x) + \varepsilon$
 - b. $1/y = \beta_0 + \beta_1x + \varepsilon$
 - c. $y = x/(\beta_0 - \beta_1x) + \varepsilon$
- All of these models can be linearized by reciprocal transformations. Sketch the behavior of y as a function of x . What observed characteristics in the scatter diagram would lead you to choose one of these models?
- 5.9** Consider the clathrate formation data in Table B.8.
- a. Perform a thorough residual analysis of these data.
 - b. Identify the most appropriate transformation for these data. Fit this model and repeat the residual analysis.
- 5.10** Consider the pressure drop data in Table B.9.
- a. Perform a thorough residual analysis of these data.
 - b. Identify the most appropriate transformation for these data. Fit this model and repeat the residual analysis.
- 5.11** Consider the kinematic viscosity data in Table B.10.
- a. Perform a thorough residual analysis of these data.
 - b. Identify the most appropriate transformation for these data. Fit this model and repeat the residual analysis.
- 5.12** Vining and Myers (“Combining Taguchi and Response Surface Philosophies: A Dual Response Approach,” *Journal of Quality Technology*, **22**, 15–22, 1990) analyze an experiment, which originally appeared in Box and Draper [1987]. This experiment studied the effect of speed (x_1), pressure (x_2), and distance (x_3) on a printing machine’s ability to apply coloring inks on package labels. The following table summarizes the experimental results.

i	x_1	x_2	x_3	y_{i1}	y_{i2}	y_{i3}	\bar{y}_i	s_i
1	-1	-1	-1	34	10	28	24.0	12.5
2	0	-1	-1	115	116	130	120.3	8.4
3	1	-1	-1	192	186	263	213.7	42.8
4	-1	0	-1	82	88	88	86.0	3.7
5	0	0	-1	44	178	188	136.7	80.4
6	1	0	-1	322	350	350	340.7	16.2
7	-1	1	-1	141	110	86	112.3	27.6
8	0	1	-1	259	251	259	256.3	4.6
9	1	1	-1	290	280	245	271.7	23.6
10	-1	-1	0	81	81	81	81.0	0.0
11	0	-1	0	90	122	93	101.7	17.7
12	1	-1	0	319	376	376	357.0	32.9

(Continued)

i	x_i	x_2	x_3	y_{i1}	y_{i2}	y_{i3}	\bar{y}_i	s_i
13	-1	0	0	180	180	154	171.3	15.0
14	0	0	0	372	372	372	372.0	0.0
15	1	0	0	541	568	396	501.7	92.5
16	-1	1	0	288	192	312	264.0	63.5
17	0	1	0	432	336	513	427.0	88.6
18	1	1	0	713	725	754	730.7	21.1
19	-1	-1	1	364	99	199	220.7	133.8
20	0	-1	1	232	221	266	239.7	23.5
21	1	-1	1	408	415	443	422.0	18.5
22	-1	0	1	182	233	182	199.0	29.4
23	0	0	1	507	515	434	485.3	44.6
24	1	0	1	846	535	640	673.7	158.2
25	-1	1	1	236	126	168	176.7	55.5
26	0	1	1	660	440	403	501.0	138.9
27	1	1	1	878	991	1161	1010.0	142.5

- a. Fit an appropriate modal to each response and conduct the residual analysis.
- b. Use the sample variances as the basis for weighted least-squares estimation of the original data (not the sample means).
- c. Vining and Myers suggest fitting a linear model to an appropriate transformation of the sample variances. Use such a model to develop the appropriate weights and repeat part b.

5.13 Schubert et al. (“The Catapult Problem: Enhanced Engineering Modeling Using Experimental Design,” *Quality Engineering*, **4**, 463–473, 1992) conducted an experiment with a catapult to determine the effects of hook (x_1), arm length (x_2), start angle (x_3), and stop angle (x_4) on the distance that the catapult throws a ball. They threw the ball three times for each setting of the factors. The following table summarizes the experimental results.

x_1	x_2	x_3	x_4	y		
-1	-1	-1	-1	28.0	27.1	26.2
-1	-1	1	1	46.3	43.5	46.5
-1	1	-1	1	21.9	21.0	20.1
-1	1	1	-1	52.9	53.7	52.0
1	-1	-1	1	75.0	73.1	74.3
1	-1	1	-1	127.7	126.9	128.7
1	1	-1	-1	86.2	86.5	87.0
1	1	1	1	195.0	195.9	195.7

- a. Fit a first-order regression model to the data and conduct the residual analysis.
- b. Use the sample variances as the basis for weighted least-squares estimation of the original data (not the sample means).

- c. Fit an appropriate model to the sample variances (note: you will require an appropriate transformation!). Use this model to develop the appropriate weights and repeat part b.
- 5.14** Consider the simple linear regression model $y_i = \beta_0 + \beta_1 x_i + \varepsilon_i$, where the variance of ε_i is proportional to x_i^2 , that is, $\text{Var}(\varepsilon_i) = \sigma^2 x_i^2$.
- Suppose that we use the transformations $y' = y/x$ and $x' = 1/x$. Is this a variance-stabilizing transformation?
 - What are the relationships between the parameters in the original and transformed models?
 - Suppose we use the method of weighted least squares with $w_i = 1/x_i^2$. Is this equivalent to the transformation introduced in part a?
- 5.15** Suppose that we want to fit the no-intercept model $y = \beta x + \varepsilon$ using weighted least squares. Assume that the observations are uncorrelated but have unequal variances.
- Find a general formula for the weighted least-squares estimator of β .
 - What is the variance of the weighted least-squares estimator?
 - Suppose that $\text{Var}(y_i) = cx_i$, that is, the variance of y_i is proportional to the corresponding x_i . Using the results of parts a and b, find the weighted least-squares estimator of β and the variance of this estimator.
 - Suppose that $\text{Var}(y_i) = cx_i^2$, that is, the variance of y_i is proportional to the square of the corresponding x_i . Using the results of parts a and b, find the weighted least-squares estimator of β and the variance of this estimator.
- 5.16** Consider the model

$$\mathbf{y} = \mathbf{X}_1 \boldsymbol{\beta}_1 + \mathbf{X}_2 \boldsymbol{\beta}_2 + \boldsymbol{\varepsilon}$$

where $E(\boldsymbol{\varepsilon}) = \mathbf{0}$ and $\text{Var}(\boldsymbol{\varepsilon}) = \sigma^2 \mathbf{V}$. Assume that σ^2 and \mathbf{V} are known. Derive an appropriate test statistic for the hypotheses

$$H_0: \boldsymbol{\beta}_2 = \mathbf{0}, \quad H_1: \boldsymbol{\beta}_2 \neq \mathbf{0}$$

Give the distribution under both the null and alternative hypotheses.

- 5.17** Consider the model

$$\mathbf{y} = \mathbf{X}\boldsymbol{\beta} + \boldsymbol{\varepsilon}$$

where $E(\boldsymbol{\varepsilon}) = \mathbf{0}$ and $\text{Var}(\boldsymbol{\varepsilon}) = \sigma^2 \mathbf{V}$. Assume that \mathbf{V} is known but not σ^2 . Show that

$$\left(\mathbf{y}' \mathbf{V}^{-1} \mathbf{y} - \mathbf{y}' \mathbf{V}^{-1} \mathbf{X} (\mathbf{X}' \mathbf{V}^{-1} \mathbf{X})^{-1} \mathbf{X}' \mathbf{V}^{-1} \mathbf{y} \right) / (n - p)$$

is an unbiased estimate of σ^2 .

- 5.18** Table B.14 contains data on the transient points of an electronic inverter. Delete the second observation and use $x_1 - x_4$ as regressors. Fit a multiple regression model to these data.
- Plot the ordinary residuals, the studentized residuals, and R -student versus the predicted response. Comment on the results.
 - Investigate the utility of a transformation on the response variable. Does this improve the model?
 - In addition to a transformation on the response, consider transformations on the regressors. Use partial regression or partial residual plots as an aid in this study.
- 5.19** Consider the following subsampling model:

$$y_{ij} = \beta_0 + \beta_1 x_i + \delta_i + \varepsilon_{ij} \quad (i = 1, 2, \dots, m \text{ and } j = 1, 2, \dots, r) \quad (5.22)$$

where m is the number of helicopters, r is the number of measured flight times for each helicopter, y_{ij} is the flight time for the j^{th} flight of the i^{th} helicopter, x_i is the length of the wings for the i^{th} helicopter, δ_i is the error term associated with the i^{th} helicopter, and ε_{ij} is the random error associated with the j^{th} flight of the i^{th} helicopter. Assume that the δ_i s are independent and normally distributed with a mean of 0 and a constant variance σ_δ^2 , that the ε_{ij} s are independent and normally distributed with mean 0 and constant variance σ^2 , and that the δ_i s and the ε_{ij} s are independent. The total number of observations in this study is $n = \sum_{i=1}^m r_i$. This model in matrix form is

$$\mathbf{y} = \mathbf{X}\boldsymbol{\beta} + \mathbf{Z}\boldsymbol{\delta} + \boldsymbol{\varepsilon}$$

where \mathbf{Z} is a $n \times m$ “incidence” matrix and $\boldsymbol{\delta}$ is a $m \times 1$ vector of random helicopter-to-helicopter errors. The form of \mathbf{Z} is

$$\mathbf{Z} = \begin{bmatrix} \mathbf{1}_r & \mathbf{0} & \dots & \mathbf{0} \\ \mathbf{0} & \mathbf{1}_r & \dots & \mathbf{0} \\ \vdots & \vdots & \vdots & \vdots \\ \mathbf{0} & \mathbf{0} & \dots & \mathbf{1}_r \end{bmatrix}$$

where $\mathbf{1}_r$ is a $r \times 1$ vector of ones.

- a.** Show that

$$\text{Var}(\mathbf{y}) = \sigma^2 \mathbf{I} + \sigma_\delta^2 \mathbf{Z}\mathbf{Z}'.$$

- Show that the ordinary least squares estimates of $\boldsymbol{\beta}$ are the same as the generalized least squares estimates.
 - Derive the appropriate error term for testing the regression coefficients.
- 5.20** The fuel consumption data in Appendix B.18 is actually a subsampling problem. The batches of oil are divided into two. One batch went to the bus, and the other batch went to the truck. Perform the proper analysis of these data.

- 5.21** A construction engineer studied the effect of mixing rate on the tensile strength of portland cement. From each batch she mixed, the engineer made four test samples. Of course, the mix rate was applied to the entire batch. The data follow. Perform the appropriate analysis.

Mix Rate(rpm)	Tensile Strength(lb/in ²)			
150	3129	3000	3065	3190
175	3200	3300	2975	3150
200	2800	2900	2985	3050
225	2600	2700	2600	2765

- 5.22** A ceramic chemist studied the effect of four peak kiln temperatures on the density of bricks. Her test kiln could hold five bricks at a time. Two samples, each from different peak temperatures, broke before she could test their density. The data follow. Perform the appropriate analysis.

Temp.	Density				
900	21.8	21.9	21.7	21.6	21.7
910	22.7	22.4	22.5	22.4	
920	23.9	22.8	22.8	22.6	22.5
930	23.4	23.2	23.3	22.9	

- 5.23** A paper manufacturer studied the effect of three vat pressures on the strength of one of its products. Three batches of cellulose were selected at random from the inventory. The company made two production runs for each pressure setting from each batch. As a result, each batch produced a total of six production runs. The data follow. Perform the appropriate analysis.

Batch	Pressure	Strength
A	400	198.4
A	400	198.6
A	500	199.6
A	500	200.4
A	600	200.6
A	600	200.9
B	400	197.5
B	400	198.1
B	500	198.7
B	500	198.0
B	600	199.6
B	600	199.0

(Continued)

Batch	Pressure	Strength
C	400	197.6
C	400	198.4
C	500	197.0
C	500	197.8
C	600	198.5
C	600	199.8

5.24 French and Schultz (“Water Use Efficiency of Wheat in a Mediterranean-type Environment, I The Relation between Yield, Water Use, and Climate,” *Australian Journal of Agricultural Research*, **35**, 743–64) studied the impact of water use on the yield of wheat in Australia. The data below are from 1970 for several locations assumed to be randomly selected for this study. The response, y , is the yield of wheat in kg/ha. The regressors are:

- x_1 the amount of rain in mm for the period October to April.
- x_2 is the number of days in the growing season.
- x_3 is the amount of rain in mm during the growing season.
- x_4 is the water use in mm for the growing season.
- x_5 is the pan evaporation in mm during the growing season.

Perform a thorough analysis of these data.

Location	x_1	x_2	x_3	x_4	x_5	y
A	227	145	196	203	727	810
B	243	194	193	226	810	1500
B	254	183	195	268	790	1340
C	296	179	239	327	711	2750
C	296	181	239	304	705	3240
D	327	196	358	388	641	2860
E	441	189	363	465	663	4970
F	356	186	340	441	846	3780
G	419	195	340	387	713	2740
H	293	182	235	306	638	3190
I	274	182	201	220	638	2350
J	363	194	316	370	766	4440
K	253	189	255	340	778	2110

CHAPTER 6

DIAGNOSTICS FOR LEVERAGE AND INFLUENCE

6.1 IMPORTANCE OF DETECTING INFLUENTIAL OBSERVATIONS

When we compute a sample average, each observation in the sample has the same weight in determining the outcome. In the regression situation, this is not the case. For example, we noted in Section 2.9 that the location of observations in x space can play an important role in determining the regression coefficients (refer to Figures 2.8 and 2.9). We have also focused attention on outliers, or observations that have unusual y values. In Section 4.4 we observed that outliers are often identified by unusually large residuals and that these observations can also affect the regression results. The material in this chapter is an extension and consolidation of some of these issues.

Consider the situation illustrated in Figure 6.1. The point labeled A in this figure is remote in x space from the rest of the sample, but it lies almost on the regression line passing through the rest of the sample points. This is an example of a **leverage** point; that is, it has an unusual x value and may control certain model properties. Now this point does not affect the estimates of the regression coefficients, but it certainly will have a dramatic effect on the model summary statistics such as R^2 and the standard errors of the regression coefficients. Now consider the point labeled A in Figure 6.2. This point has a moderately unusual x coordinate, and the y value is unusual as well. This is an **influence** point, that is, it has a noticeable impact on the model coefficients in that it “pulls” the regression model in its direction.

We sometimes find that a small subset of the data exerts a disproportionate influence on the model coefficients and properties. In an extreme case, the parameter estimates may depend more on the influential subset of points than on the majority of the data. This is obviously an undesirable situation; we would like for a regression

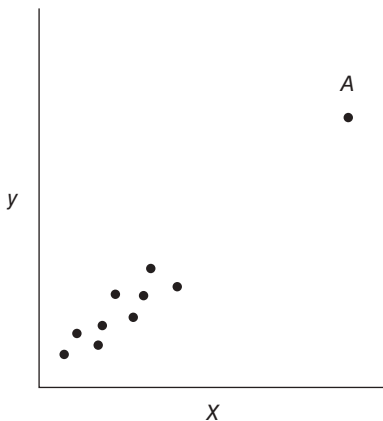

Figure 6.1 An example of a leverage point.

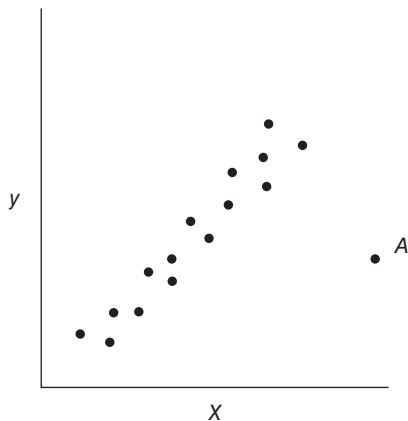

Figure 6.2 An example of an influential observation.

model to be representative of all of the sample observations, not an artifact of a few. Consequently, we would like to find these influential points and assess their impact on the model. If these influential points are indeed “bad” values, then they should be eliminated from the sample. On the other hand, there may be nothing wrong with these points, but if they control key model properties, we would like to know it, as it could affect the end use of the regression model.

In this chapter we present several diagnostics for leverage and influence. These diagnostics are available in most multiple regression computer packages. It is important to use these diagnostics in conjunction with the residual analysis techniques of Chapter 4. Sometimes we find that a regression coefficient may have a sign that does not make engineering or scientific sense, a regressor known to be important may be statistically insignificant, or a model that fits the data well and that is logical from an application–environment perspective may produce poor predictions. These situations may be the result of one or perhaps a few influential observations. Finding these observations then can shed considerable light on the problems with the model.

6.2 LEVERAGE

As observed above, the location of points in x space is potentially important in determining the properties of the regression model. In particular, remote points potentially have disproportionate impact on the parameter estimates, standard errors, predicted values, and model summary statistics. The hat matrix

$$\mathbf{H} = \mathbf{X}(\mathbf{X}'\mathbf{X})^{-1}\mathbf{X}' \quad (6.1)$$

plays an important role in identifying influential observations. As noted earlier, \mathbf{H} determines the variances and covariances of $\hat{\mathbf{y}}$ and \mathbf{e} , since $\text{Var}(\hat{\mathbf{y}}) = \sigma^2\mathbf{H}$ and $\text{Var}(\mathbf{e}) = \sigma^2(\mathbf{I} - \mathbf{H})$. The elements h_{ij} of the matrix \mathbf{H} may be interpreted as the amount of **leverage** exerted by the i th observation y_i on the j th fitted value \hat{y}_j .

We usually focus attention on the **diagonal elements** h_{ii} of the hat matrix \mathbf{H} , which may be written as

$$h_{ii} = \mathbf{x}'_i (\mathbf{X}'\mathbf{X})^{-1} \mathbf{x}_i \quad (6.2)$$

where \mathbf{x}'_i is the i th row of the \mathbf{X} matrix. The hat matrix diagonal is a standardized measure of the distance of the i th observation from the center (or centroid) of the x space. Thus, large hat diagonals reveal observations that are potentially influential because they are remote in x space from the rest of the sample. It turns out that the average size of a hat diagonal is $\bar{h} = p/n$ [because $\sum_{i=1}^n h_{ii} = \text{rank}(\mathbf{H}) = \text{rank}(\mathbf{X}) = p$], and we traditionally assume that any observation for which the hat diagonal exceeds twice the average $2p/n$ is remote enough from the rest of the data to be considered a **leverage point**.

Not all leverage points are going to be influential on the regression coefficients. For example, recall point A in Figure 6.1. This point will have a large hat diagonal and is assuredly a leverage point, but it has almost no effect on the regression coefficients because it lies almost on the line passing through the remaining observations. Because the hat diagonals examine only the location of the observation in x space, some analysts like to look at the studentized residuals or R -student **in conjunction with** the h_{ii} . Observations with large hat diagonals **and** large residuals are likely to be influential. Finally, note that in using the cutoff value $2p/n$ we must also be careful to assess the magnitudes of both p and n . There will be situations where $2p/n > 1$, and in these situations, the cutoff does not apply.

Example 6.1 The Delivery Time Data

Column a of Table 6.1 shows the hat diagonals for the soft drink delivery time data Example 3.1. Since $p = 3$ and $n = 25$, any point for which the hat diagonal h_{ii} exceeds $2p/n = 2(3)/25 = 0.24$ is a leverage point. This criterion would identify observations 9 and 22 as leverage points. The remote location of these points (particularly point 9) was previously noted when we examined the matrix of scatterplots in Figure 3.4 and when we illustrated interpolation and extrapolation with this model in Figure 3.11.

In Example 4.1 we calculated the scaled residuals for the delivery time data. Table 4.1 contains the studentized residuals and R -student. These residuals are not unusually large for observation 22, indicating that it likely has little influence on the fitted model. However, both scaled residuals for point 9 are moderately large, suggesting that this observation may have moderate influence on the model. To illustrate the effect of these two points on the model, three additional analyses were performed: one deleting observation 9, a second deleting observation 22, and the third deleting both 9 and 22. The results of these additional runs are shown in the following table:

Run	$\hat{\beta}_0$	$\hat{\beta}_1$	$\hat{\beta}_2$	MS_{Res}	R^2
9 and 22 in	2.341	1.616	0.014	10.624	0.9596
9 out	4.447	1.498	0.010	5.905	0.9487
22 out	1.916	1.786	0.012	10.066	0.9564
9 and 22 out	4.643	1.456	0.011	6.163	0.9072

TABLE 6.1 Statistics for Detecting Influential Observations for the Soft Drink Delivery Time Data

Observation i	(a) h_{ii}	(b) D_i	(c) $DFFITs_i$	(d) Intercept $DFBETAS_{0,i}$	(e) Cases $DFBETAS_{1,i}$	(f) Distance $DFBETAS_{2,i}$	(g) $COVRATIO_i$
1	0.10180	0.10009	-0.5709	-0.1873	0.4113	-0.4349	0.8711
2	0.07070	0.00338	0.0986	0.0898	-0.0478	0.0144	1.2149
3	0.09874	0.00001	-0.0052	-0.0035	0.0039	-0.0028	1.2757
4	0.08538	0.07766	0.5008	0.4520	0.0883	-0.2734	0.8760
5	0.07501	0.00054	-0.0395	-0.0317	-0.0133	0.0242	1.2396
6	0.04287	0.00012	-0.0188	-0.0147	0.0018	0.0011	1.1999
7	0.08180	0.00217	0.0790	0.0781	-0.0223	-0.0110	1.2398
8	0.06373	0.00305	0.0938	0.0712	0.0334	-0.0538	1.2056
9	0.49829	3.41835	4.2961	-2.5757	0.9287	1.5076	0.3422
10	0.19630	0.05385	0.3987	0.1079	-0.3382	0.3413	1.3054
11	0.08613	0.01620	0.2180	-0.0343	0.0925	-0.0027	1.1717
12	0.11366	0.00160	-0.0677	-0.0303	-0.0487	0.0540	1.2906
13	0.06113	0.00229	0.0813	0.0724	-0.0356	0.0113	1.2070
14	0.07824	0.00329	0.0974	0.0495	-0.0671	0.0618	1.2277
15	0.04111	0.00063	0.0426	0.0223	-0.0048	0.0068	1.1918
16	0.16594	0.00329	-0.0972	-0.0027	0.0644	-0.0842	1.3692
17	0.05943	0.00040	0.0339	0.0289	0.0065	-0.0157	1.2192
18	0.09626	0.04398	0.3653	0.2486	0.1897	-0.2724	1.0692
19	0.09645	0.01192	0.1862	0.1726	0.0236	-0.0990	1.2153
20	0.10169	0.13246	-0.6718	0.1680	-0.2150	-0.0929	0.7598
21	0.16528	0.05086	-0.3885	-0.1619	-0.2972	0.3364	1.2377
22	0.39158	0.45106	-1.1950	0.3986	-1.0254	0.5731	1.3981
23	0.04126	0.02990	-0.3075	-0.1599	0.0373	-0.0527	0.8897
24	0.12061	0.10232	-0.5711	-0.1197	0.4046	-0.4654	0.9476
25	0.06664	0.00011	-0.0176	-0.0168	0.0008	0.0056	1.2311

Deleting observation 9 produces only a minor change in $\hat{\beta}_1$ but results in approximately a 28% change in $\hat{\beta}_2$ and a 90% change in $\hat{\beta}_0$. This illustrates that observation 9 is off the plane passing through the other 24 points and exerts a moderately strong influence on the regression coefficient associated with x_2 (distance). This is not surprising considering that the value of x_2 for this observation (1460 feet) is very different from the other observations. In effect, observation 9 may be causing curvature in the x_2 direction. If observation 9 were deleted, then MS_{Res} would be reduced to 5.905. Note that $\sqrt{5.905} = 2.430$, which is not too different from the estimate of pure error $\hat{\sigma} = 1.969$ found by the near-neighbor analysis in Example 4.10. It seems that most of the lack of fit noted in this model in Example 4.11 is due to point 9's large residual. Deleting point 22 produces relative smaller changes in the regression coefficients and model summary statistics. Deleting both points 9 and 22 produces changes similar to those observed when deleting only 9. ■

The SAS code to generate its influence diagnostics is:

```
model time = cases dist / influence;
```

The R code is:

```
deliver.model <- lm(time~cases+dist, data=deliver)
summary(deliver.model)
print(influence.measures(deliver.model))
```

6.3 MEASURES OF INFLUENCE: COOK'S D

We noted in the previous section that it is desirable to consider both the location of the point in the x space and the response variable in measuring influence. Cook [1977, 1979] has suggested a way to do this, using a measure of the squared distance between the least-squares estimate based on all n points $\hat{\beta}$ and the estimate obtained by deleting the i th point, say $\hat{\beta}_{(i)}$. This distance measure can be expressed in a general form as

$$D_i = (\mathbf{M}, c) = \frac{(\hat{\beta}_{(i)} - \hat{\beta})' \mathbf{M} (\hat{\beta}_{(i)} - \hat{\beta})}{c}, \quad i = 1, 2, \dots, n \quad (6.3)$$

The usual choices of \mathbf{M} and c are $\mathbf{M} = \mathbf{X}'\mathbf{X}$ and $c = pMS_{Res}$, so that Eq. (6.3) becomes

$$D_i(\mathbf{X}'\mathbf{X}, pMS_{Res}) \equiv D_i = \frac{(\hat{\beta}_{(i)} - \hat{\beta})' \mathbf{X}'\mathbf{X} (\hat{\beta}_{(i)} - \hat{\beta})}{pMS_{Res}}, \quad i = 1, 2, \dots, n \quad (6.4)$$

Points with large values of D_i have considerable influence on the least-squares estimates $\hat{\beta}$.

The magnitude of D_i is usually assessed by comparing it to $F_{\alpha, p, n-p}$. If $D_i = F_{0.5, p, n-p}$, then deleting point i would move $\hat{\beta}_{(i)}$ to the boundary of an approximate 50% confidence region for β based on the complete data set. This is a large displacement

and indicates that the least-squares estimate is sensitive to the i th data point. Since $F_{0.5,p,n-p} \approx 1$, we usually consider points for which $D_i > 1$ to be influential. Ideally we would like each estimate $\hat{\beta}_{(i)}$ to stay within the boundary of a 10 or 20% confidence region. This recommendation for a cutoff is based on the similarity of D_i to the equation for the normal-theory confidence ellipsoid [Eq. (3.50)]. The distance measure D_i is not an F statistic. However, the cutoff of unity works very well in practice.

The D_i statistic may be rewritten as

$$D_i = \frac{r_i^2}{p} \frac{\text{Var}(\hat{y}_i)}{\text{Var}(e_i)} = \frac{r_i^2}{p} \frac{h_{ii}}{1-h_{ii}}, \quad i = 1, 2, \dots, n \quad (6.5)$$

Thus, we see that, apart from the constant p , D_i is the product of the square of the i th studentized residual and $h_{ii}/(1-h_{ii})$. This ratio can be shown to be the distance from the vector \mathbf{x}_i to the centroid of the remaining data. Thus, D_i is made up of a component that reflects how well the model fits the i th observation y_i and a component that measures how far that point is from the rest of the data. Either component (or both) may contribute to a large value of D_i . Thus, D_i combines residual magnitude for the i th observation and the location of that point in x space to assess influence.

Because $\mathbf{X}\hat{\beta}_{(i)} - \mathbf{X}\hat{\beta} = \hat{y}_{(i)} - \hat{y}$, another way to write Cook's distance measure is

$$D_i = \frac{(\hat{y}_{(i)} - \hat{y})' (\hat{y}_{(i)} - \hat{y})}{pMS_{\text{Res}}} \quad (6.6)$$

Therefore, another way to interpret Cook's distance is that it is the squared Euclidean distance (apart from pMS_{Res}) that the vector of fitted values moves when the i th observation is deleted.

Example 6.2 The Delivery Time Data

Column b of Table 6.1 contains the values of Cook's distance measure for the soft drink delivery time data. We illustrate the calculations by considering the first observation. The studentized residuals for the delivery time data in Table 4.1, and $r_1 = -1.6277$. Thus,

$$D_1 = \frac{r_1^2}{p} \frac{h_{11}}{1-h_{11}} = \frac{(-1.6277)^2}{3} \frac{0.10180}{1-0.10180} = 0.10009$$

The largest value of the D_i statistic is $D_9 = 3.41835$, which indicates that deletion of observation 9 would move the least-squares estimate to approximately the boundary of a 96% confidence region around $\hat{\beta}$. The next largest value is $D_{22} = 0.45106$, and deletion of point 22 will move the estimate of β to approximately the edge of a 35% confidence region. Therefore, we would conclude that observation 9 is definitely influential using the cutoff of unity, and observation 22 is not influential. Notice that these conclusions agree quite well with those reached in Example 6.1 by examining the hat diagonals and studentized residuals separately. ■

6.4 MEASURES OF INFLUENCE: *DFFITS* AND *DFBETAS*

Cook's distance measure is a **deletion diagnostic**, that is, it measures the influence of the i th observation if it is removed from the sample. Belsley, Kuh, and Welsch [1980] introduced two other useful measures of deletion influence. The first of these is a statistic that indicates how much the regression coefficient $\hat{\beta}_j$ changes, in standard deviation units, if the i th observation were deleted. This statistic is

$$DFBETAS_{j,i} = \frac{\hat{\beta}_j - \hat{\beta}_{j(i)}}{\sqrt{S_{(i)}^2 C_{jj}}} \quad (6.7)$$

where C_{jj} is the j th diagonal element of $(\mathbf{X}'\mathbf{X})^{-1}$ and $\hat{\beta}_{j(i)}$ is the j th regression coefficient computed without use of the i th observation. A large (in magnitude) value of $DFBETAS_{j,i}$ indicates that observation i has considerable influence on the j th regression coefficient. Notice that $DFBETAS_{j,i}$ is an $n \times p$ matrix that conveys similar information to the composite influence information in Cook's distance measure.

The computation of $DFBETAS_{j,i}$ is interesting. Define the $p \times n$ matrix

$$\mathbf{R} = (\mathbf{X}'\mathbf{X})^{-1} \mathbf{X}'$$

The n elements in the j th row of \mathbf{R} produce the leverage that the n observations in the sample have on $\hat{\beta}_j$. If we let \mathbf{r}'_j denote the j th row of \mathbf{R} , then we can show (see Appendix C.13) that

$$DFBETAS_{j,i} = \frac{r_{j,i}}{\sqrt{\mathbf{r}'_j \mathbf{r}_j}} \frac{e_i}{S_{(i)}(1-h_{ii})} = \frac{r_{j,i}}{\sqrt{\mathbf{r}'_j \mathbf{r}_j}} \frac{t_i}{\sqrt{1-h_{ii}}} \quad (6.8)$$

where t_i is the R -student residual. Note that $DFBETAS_{j,i}$ measures both leverage ($r_{j,i}/\sqrt{\mathbf{r}'_j \mathbf{r}_j}$ is a measure of the impact of the i th observation on $\hat{\beta}_j$) and the effect of a large residual. Belsley, Kuh, and Welsch [1980] suggest a cutoff of $2/\sqrt{n}$ for $DFBETAS_{j,i}$; that is, if $|DFBETAS_{j,i}| > 2/\sqrt{n}$, then the i th observation warrants examination.

We may also investigate the deletion influence of the i th observation on the predicted or fitted value. This leads to the second diagnostic proposed by Belsley, Kuh, and Welsch:

$$DFFITS_i = \frac{\hat{y}_i - \hat{y}_{(i)}}{\sqrt{S_{(i)}^2 h_{ii}}}, \quad i = 1, 2, \dots, n \quad (6.9)$$

where $\hat{y}_{(i)}$ is the fitted value of y_i obtained without the use of the i th observation. The denominator is just a standardization, since $\text{Var}(\hat{y}_i) = \sigma^2 h_{ii}$. Thus, $DFFITS_i$ is the number of standard deviations that the fitted value \hat{y}_i **changes** if observation i is removed.

Computationally we may find (see Appendix C.13 for details)

$$DFFITS_i = \left(\frac{h_{ii}}{1-h_{ii}} \right)^{1/2} \frac{e_i}{S_{(i)}(1-h_{ii})^{1/2}} = \left(\frac{h_{ii}}{1-h_{ii}} \right)^{1/2} t_i \quad (6.10)$$

where t_i is R -student. Thus, $DFFITs_i$ is the value of R -student multiplied by the leverage of the i th observation $[h_{ii}/(1 - h_{ii})]^{1/2}$. If the data point is an outlier, then R -student will be large in magnitude, while if the data point has high leverage, h_{ii} will be close to unity. In either of these cases $DFFITs_i$ can be large. However, if $h_{ii} = 0$, the effect of R -student will be moderated. Similarly a near-zero R -student combined with a high leverage point could produce a small value of $DFFITs_i$. Thus, $DFFITs_i$ is affected by both leverage and prediction error. Belsley, Kuh, and Welsch suggest that any observation for which $|DFFITs_i| > 2\sqrt{p/n}$ warrants attention.

A Remark on Cutoff Values In this section we have provided recommended cutoff values for $DFFITs_i$ and $DFBETAs_{j,i}$. Remember that these recommendations are only guidelines, as it is very difficult to produce cutoffs that are correct for all cases. Therefore, we recommend that the analyst utilize information about both what the diagnostic means and the application environment in selecting a cutoff. For example, if $DFFITs_i = 1.0$, say, we could translate this into actual response units to determine just how much \hat{y}_i is affected by removing the i th observation. Then $DFBETAs_{j,i}$ could be used to see whether this observation is responsible for the significance (or perhaps nonsignificance) of particular coefficients or for changes of sign in a regression coefficient. Diagnostic $DFBETAs_{j,i}$ can also be used to determine (by using the standard error of the coefficient) how much change in actual **problem-specific units** a data point has on the regression coefficient. Sometimes these changes will be important in a **problem-specific context** even though the diagnostic statistics do not exceed the formal cutoff.

Notice that the recommended cutoffs are a function of sample size n . Certainly, we believe that any formal cutoff should be a function of sample size; however, in our experience these cutoffs often identify more data points than an analyst may wish to analyze. This is particularly true in small samples. We believe that the cutoffs recommended by Belsley, Kuh, and Welsch make sense for large samples, but when n is small, we prefer the diagnostic view discussed previously.

Example 6.3 The Delivery Time Data

Columns c–f of Table 6.1 present the values of $DFFITs_i$ and $DFBETAs_{j,i}$ for the soft drink delivery time data. The formal cutoff value for $DFFITs_i$ is $2\sqrt{p/n} = 2\sqrt{3/25} = 0.69$. Inspection of Table 6.1 reveals that both points 9 and 22 have values of $DFFITs_i$ that exceed this value, and additionally $DFFITs_{20}$ is close to the cutoff.

Examining $DFBETAs_{j,i}$ and recalling that the cutoff is $2/\sqrt{25} = 0.40$, we immediately notice that points 9 and 22 have large effects on all three parameters. Point 9 has a very large effect on the intercept and smaller effects on $\hat{\beta}_1$ and $\hat{\beta}_2$, while point 22 has its largest effect on $\hat{\beta}_1$. Several other points produce effects on the coefficients that are close to the formal cutoff, including 1 (on $\hat{\beta}_1$ and $\hat{\beta}_2$), 4 (on $\hat{\beta}_0$), and 24 (on $\hat{\beta}_1$ and $\hat{\beta}_2$). These points produce relatively small changes in comparison to point 9.

Adopting a diagnostic view, point 9 is clearly influential, since its deletion results in a displacement of every regression coefficient by at least 0.9 standard deviation. The effect of point 22 is much smaller. Furthermore, deleting point 9 displaces the

predicted response by over four standard deviations. Once again, we have a clear signal that observation 9 is influential. ■

6.5 A MEASURE OF MODEL PERFORMANCE

The diagnostics D_i , $DFBETAS_{j,i}$, and $DFFITs_i$ provide insight about the effect of observations on the estimated coefficients $\hat{\beta}_j$ and fitted values \hat{y}_i . They do not provide any information about overall **precision of estimation**. Since it is fairly common practice to use the determinant of the covariance matrix as a convenient scalar measure of precision, called the **generalized variance**, we could define the generalized variance of $\hat{\beta}$ as

$$GV(\hat{\beta}) = |\text{Var}(\hat{\beta})| = |\sigma^2 (\mathbf{X}'\mathbf{X})^{-1}|$$

To express the role of the i th observation on the precision of estimation, we could define

$$COVRATIO_i = \frac{|(\mathbf{X}'_{(i)}\mathbf{X}_{(i)})^{-1} S_{(i)}^2|}{|(\mathbf{X}'\mathbf{X})^{-1} MS_{\text{Res}}|}, \quad i = 1, 2, \dots, n \tag{6.11}$$

Clearly if $COVRATIO_i > 1$, the i th observation improves the precision of estimation, while if $COVRATIO_i < 1$, inclusion of the i th point degrades precision. Computationally

$$COVRATIO_i = \frac{(S_{(i)}^2)^p}{MS_{\text{Res}}^p} \left(\frac{1}{1 - h_{ii}} \right) \tag{6.12}$$

Note that $[1/(1 - h_{ii})]$ is the ratio of $|(\mathbf{X}'_{(i)}\mathbf{X}_{(i)})^{-1}|$ to $|(\mathbf{X}'\mathbf{X})^{-1}|$, so that a high leverage point will make $COVRATIO_i$ large. This is logical, since a high leverage point will improve the precision unless the point is an outlier in y space. If the i th observation is an outlier, $S_{(i)}^2/MS_{\text{Res}}$ will be much less than unity.

Cutoff values for $COVRATIO$ are not easy to obtain. Belsley, Kuh, and Welsch [1980] suggest that if $COVRATIO_i > 1 + 3p/n$ or if $COVRATIO_i < 1 - 3p/n$, then the i th point should be considered influential. The lower bound is only appropriate when $n > 3p$. These cutoffs are only recommended for large samples.

Example 6.4 The Delivery Time Data

Column g of Table 6.1 contains the values of $COVRATIO_i$ for the soft drink delivery time data. The formal recommended cutoff for $COVRATIO_i$ is $1 \pm 3p/n = 1 \pm 3(3)/25$, or 0.64 and 1.36. Note that the values of $COVRATIO_9$ and $COVRATIO_{22}$ exceed these limits, indicating that these points are influential. Since $COVRATIO_9 < 1$, this observation degrades precision of estimation, while since $COVRATIO_{22} > 1$, this observation tends to improve the precision. However, point 22 barely exceeds its cutoff, so the influence of this observation, from a practical viewpoint, is fairly small. Point 9 is much more clearly influential. ■

6.6 DETECTING GROUPS OF INFLUENTIAL OBSERVATIONS

We have focused on single-observation deletion diagnostics for influence and leverage. Now obviously, there could be situations where a **group** of points have high leverage or exert undue influence on the regression model. Very good discussions of this problem are in Belsley, Kuh, and Welsch [1980] and Rousseeuw and Leroy [1987].

In principle, we can extend the single-observation diagnostics to the multiple observation case. In fact, there are several strategies for solving the multiple-outlier influential observation problem. For example, see Atkinson [1994], Hadi and Simonoff [1993], Hawkins, Bradu, and Kass [1984], Pena and Yohai [1995], and Rousseeuw and van Zomeren [1990]. To show how we could extend Cook's distance measure to assess the simultaneous influence of a group of m observations, let \mathbf{i} denote the $m \times 1$ vector of indices specifying the points to be deleted, and define

$$D_{\mathbf{i}}(\mathbf{X}'\mathbf{X}, pMS_{\text{Res}}) = D_{\mathbf{i}} = \frac{(\hat{\boldsymbol{\beta}}_{(\mathbf{i})} - \hat{\boldsymbol{\beta}})' \mathbf{X}'\mathbf{X} (\hat{\boldsymbol{\beta}}_{(\mathbf{i})} - \hat{\boldsymbol{\beta}})}{pMS_{\text{Res}}}$$

Obviously, $D_{\mathbf{i}}$ is a multiple-observation version of Cook's distance measure. The interpretation of $D_{\mathbf{i}}$ is similar to the single-observation statistic. Large values of $D_{\mathbf{i}}$ indicate that the set of m points are influential. Selection of the subset of points to include in m is not obvious, however, because in some data sets subsets of points are **jointly influential** but individual points are not. Furthermore, it is not practical to investigate all possible combinations of the n sample points taken $m = 1, 2, \dots, n$ points at a time.

Sebert, Montgomery, and Roilier [1998] investigate the use of **cluster analysis** to find the set of influential observations in regression. Cluster analysis is a multivariate technique for finding groups of similar observations. The procedure consists of defining a measure of similarity between observations and then using a set of rules to classify the observations into groups based on their interobservation similarities. They use a single-linkage clustering procedure (see Johnson and Wichern [1992] and Everitt [1993]) applied to the least-squares residuals and fitted values to cluster $n - m$ observations into a "clean" group and a potentially influential group of m observations. The potentially influential group of observations are then evaluated in subsets of size $1, 2, \dots, m$ using the multiple-observation version of Cook's distance measure. The authors report that this procedure is very effective in finding the subset of influential observations. There is some "swamping," that is, identifying too many observations as potentially influential, but the use of Cook's distance efficiently eliminates the noninfluential observations. In studying nine data sets from the literature, the authors report no incidents of "masking," that is, failure to find the correct subset of influential points. They also report successful results from an extensive performance study conducted by Monte Carlo simulation.

6.7 TREATMENT OF INFLUENTIAL OBSERVATIONS

Diagnostics for leverage and influence are an important part of the regression model-builder's arsenal of tools. They are intended to offer the analyst insight about

the data and to signal which observations may deserve more scrutiny. How much effort should be devoted to study of these points? It probably depends on the number of influential points identified, their actual impact on the model, and the importance of the model-building problem. If you have spent a year collecting 30 observations, then it seems probable that a lot of follow-up analysis of suspect points can be justified. This is particularly true if an unexpected result occurs because of a single influential observation.

Should influential observations ever be discarded? This question is analogous to the question regarding discarding outliers. As a general rule, if there is an error in recording a measured value or if the sample point is indeed invalid or not part of the population that was intended to be sampled, then discarding the observation is appropriate. However, if analysis reveals that an influential point is a valid observation, then there is no justification for its removal.

A “compromise” between deleting an observation and retaining it is to consider using an estimation technique that is not impacted as severely by influential points as least squares. These **robust** estimation techniques essentially **downweight** observations in proportion to residual magnitude or influence, so that a highly influential observation will receive less weight than it would in a least-squares fit. Robust regression methods are discussed in Section 15.1.

PROBLEMS

- 6.1 Perform a thorough influence analysis of the solar thermal energy test data given in Table B.2. Discuss your results.
- 6.2 Perform a thorough influence analysis of the property valuation data given in Table B.4. Discuss your results.
- 6.3 Perform a thorough influence analysis of the Belle Ayr liquefaction runs given in Table B.5. Discuss your results.
- 6.4 Perform a thorough influence analysis of the tube-flow reactor data given in Table B.6. Discuss your results.
- 6.5 Perform a thorough influence analysis of the NFL team performance data given in Table B.1. Discuss your results.
- 6.6 Perform a thorough influence analysis of the oil extraction data given in Table B.7. Discuss your results.
- 6.7 Perform a thorough influence analysis of the clathrate formation data given in Table B.8. Perform any appropriate transformations. Discuss your results.
- 6.8 Perform a thorough influence analysis of the pressure drop data given in Table B.9. Perform any appropriate transformations. Discuss your results.
- 6.9 Perform a thorough influence analysis of kinematic viscosity data given in Table B.10. Perform any appropriate transformations. Discuss your results.
- 6.10 Formally show that

$$D_i = \frac{r_i}{p} \frac{h_{ii}}{1 - h_{ii}}$$

6.11 Formally show that

$$COVRATIO_i = \left[\frac{S_{(i)}^2}{MS_{Res}} \right]^p \left(\frac{1}{1 - h_{ii}} \right)$$

- 6.12** Table B.11 contains data on the quality of Pinot Noir wine. Fit a regression model using clarity, aroma, body, flavor, and oakiness as the regressors. Investigate this model for influential observations and comment on your findings.
- 6.13** Table B.12 contains data collected on heat treating of gears. Fit a regression model to these data using all of the regressors. Investigate this model for influential observations and comment on your findings.
- 6.14** Table B.13 contains data on the thrust of a jet turbine engine. Fit a regression model to these data using all of the regressors. Investigate this model for influential observations and comment on your findings.
- 6.15** Table B.14 contains data concerning the transient points of an electronic inverter. Fit a regression model to all 25 observations but only use $x_1 - x_4$ as the regressors. Investigate this model for influential observations and comment on your findings.
- 6.16** Perform a thorough influential analysis of the air pollution and mortality data given in Table B.15. Perform any appropriate transformations. Discuss your results.
- 6.17** For each model perform a thorough influence analysis of the life expectancy data given in Table B.16. Perform any appropriate transformations. Discuss your results.
- 6.18** Consider the patient satisfaction data in Table B.17. Fit a regression model to the satisfaction response using age and security as the predictors. Perform an influence analysis of the data and comment on your findings.
- 6.19** Consider the fuel consumption data in Table B.18. For the purposes of this exercise, ignore regressor x_1 . Perform a thorough influence analysis of these data. What conclusions do you draw from this analysis?
- 6.20** Consider the wine quality of young red wines data in Table B.19. For the purposes of this exercise, ignore regressor x_1 . Perform a thorough influence analysis of these data. What conclusions do you draw from this analysis?
- 6.21** Consider the methanol oxidation data in Table B.20. Perform a thorough influence analysis of these data. What conclusions do you draw from this analysis?

CHAPTER 7

POLYNOMIAL REGRESSION MODELS

7.1 INTRODUCTION

The linear regression model $\mathbf{y} = \mathbf{X}\boldsymbol{\beta} + \boldsymbol{\varepsilon}$ is a general model for fitting any relationship that is linear in the unknown parameters $\boldsymbol{\beta}$. This includes the important class of **polynomial regression models**. For example, the second-order polynomial in one variable

$$y = \beta_0 + \beta_1x + \beta_2x^2 + \varepsilon$$

and the second-order polynomial in two variables

$$y = \beta_0 + \beta_1x_1 + \beta_2x_2 + \beta_{11}x_1^2 + \beta_{22}x_2^2 + \beta_{12}x_1x_2 + \varepsilon$$

are linear regression models.

Polynomials are widely used in situations where the response is curvilinear, as even complex nonlinear relationships can be adequately modeled by polynomials over reasonably small ranges of the x 's. This chapter will survey several problems and issues associated with fitting polynomials.

7.2 POLYNOMIAL MODELS IN ONE VARIABLE

7.2.1 Basic Principles

As an example of a **polynomial regression model** in one variable, consider

Introduction to Linear Regression Analysis, Fifth Edition. Douglas C. Montgomery, Elizabeth A. Peck, G. Geoffrey Vining.
© 2012 John Wiley & Sons, Inc. Published 2012 by John Wiley & Sons, Inc.

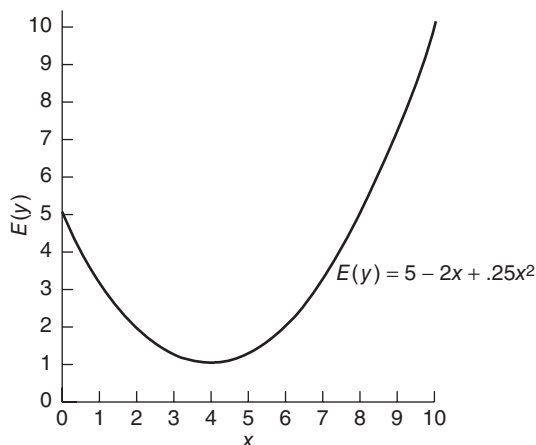

Figure 7.1 An example of a quadratic polynomial.

$$y = \beta_0 + \beta_1 x + \beta_2 x^2 + \varepsilon \quad (7.1)$$

This model is called a **second-order model** in one variable. It is also sometimes called a **quadratic model**, since the expected value of y is

$$E(y) = \beta_0 + \beta_1 x + \beta_2 x^2$$

which describes a quadratic function. A typical example is shown in Figure 7.1. We often call β_1 the linear effect parameter and β_2 the quadratic effect parameter. The parameter β_0 is the mean of y when $x = 0$ if the range of the data includes $x = 0$. Otherwise β_0 has no physical interpretation.

In general, the k th-order polynomial model in one variable is

$$y = \beta_0 + \beta_1 x + \beta_2 x^2 + \cdots + \beta^k x^k + \varepsilon \quad (7.2)$$

If we set $x_j = x^j, j = 1, 2, \dots, k$, then Eq. (7.2) becomes a multiple linear regression model in the k regressors x_1, x_2, \dots, x_k . Thus, a polynomial model of order k may be fitted using the techniques studied previously.

Polynomial models are useful in situations where the analyst knows that curvilinear effects are present in the true response function. They are also useful as approximating functions to unknown and possibly very complex nonlinear relationships. In this sense, the polynomial model is just the Taylor series expansion of the unknown function. This type of application seems to occur most often in practice.

There are several important considerations that arise when fitting a polynomial in one variable. Some of these are discussed below.

1. **Order of the Model** It is important to keep the order of the model as **low as possible**. When the response function appears to be curvilinear, **transformations** should be tried to keep the model first order. The methods discussed in Chapter 5 are useful in this regard. If this fails, a second-order polynomial

should be tried. As a general rule the use of high-order polynomials ($k > 2$) should be avoided unless they can be justified for reasons outside the data. A low-order model in a transformed variable is almost always preferable to a high-order model in the original metric. Arbitrary fitting of high-order polynomials is a serious abuse of regression analysis. One should always maintain a sense of **parsimony**, that is, use the simplest possible model that is consistent with the data and knowledge of the problem environment. Remember that in an extreme case it is always possible to pass a polynomial of order $n - 1$ through n points so that a polynomial of sufficiently high degree can always be found that provides a “good” fit to the data. In most cases, this would do nothing to enhance understanding of the unknown function, nor will it likely be a good predictor.

2. **Model-Building Strategy** Various strategies for choosing the order of an approximating polynomial have been suggested. One approach is to successively fit models of increasing order until the t test for the highest order term is nonsignificant. An alternate procedure is to appropriately fit the highest order model and then delete terms one at a time, starting with the highest order, until the highest order remaining term has a significant t statistic. These two procedures are called **forward selection** and **backward elimination**, respectively. They do not necessarily lead to the same model. In light of the comment in 1 above, these procedures should be used carefully. In most situations we should restrict our attention to first- and second-order polynomials.
3. **Extrapolation** Extrapolation with polynomial models can be extremely hazardous. For example, consider the second-order model in Figure 7.2. If we extrapolate beyond the range of the original data, the predicted response turns downward. This may be at odds with the true behavior of the system. In general, polynomial models may turn in unanticipated and inappropriate directions, both in interpolation and in extrapolation.

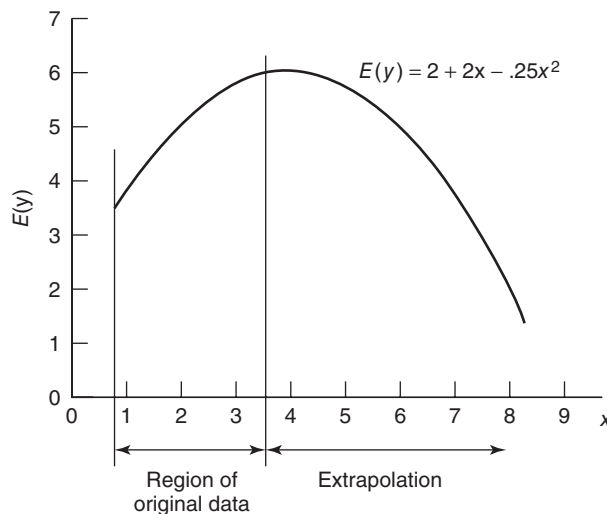

Figure 7.2 Danger of extrapolation.

4. **Ill-Conditioning I** As the order of the polynomial increases, the $\mathbf{X}'\mathbf{X}$ matrix becomes **ill-conditioned**. This means that the matrix inversion calculations will be inaccurate, and considerable error may be introduced into the parameter estimates. For example, see Forsythe [1957]. **Nonessential ill-conditioning** caused by the arbitrary choice of origin can be removed by first **centering** the **regressor variables** (i.e., correcting x for its average \bar{x}), but as Bradley and Srivastava [1979] point out, even centering the data can still result in large sample correlations between certain regression coefficients. One method for dealing with this problem will be discussed in Section 7.5.
5. **Ill-Conditioning II** If the values of x are limited to a narrow range, there can be significant ill-conditioning or multicollinearity in the columns of the \mathbf{X} matrix. For example, if x varies between 1 and 2, x^2 varies between 1 and 4, which could create strong multicollinearity between x and x^2 .
6. **Hierarchy** The regression model

$$y = \beta_0 + \beta_1 x + \beta_2 x^2 + \beta_3 x^3 + \varepsilon$$

is said to be **hierarchical** because it contains all terms of order 3 and lower. By contrast, the model

$$y = \beta_0 + \beta_1 x + \beta_3 x^3 + \varepsilon$$

is not hierarchical. Peixoto [1987, 1990] points out that only hierarchical models are invariant under linear transformation and suggests that all polynomial models should have this property (the phrase “a hierarchically well-formulated model” is frequently used). We have mixed feelings about this as a hard-and-fast rule. It is certainly attractive to have the model form preserved following a linear transformation (such as fitting the model in coded variables and then converting to a model in the natural variables), but it is purely a mathematical nicety. There are many mechanistic models that are not hierarchical; for example, Newton’s law of gravity is an inverse square law, and the magnetic dipole law is an inverse cube law. Furthermore, there are many situations in using a polynomial regression model to represent the results of a designed experiment where a model such as

$$y = \beta_0 + \beta_1 x_1 + \beta_{12} x_1 x_2 + \varepsilon$$

would be supported by the data, where the cross-product term represents a two-factor interaction. Now a hierarchical model would require the inclusion of the other main effect x_2 . However, this other term could really be entirely unnecessary from a statistical significance perspective. It may be perfectly logical from the viewpoint of the underlying science or engineering to have an interaction in the model without one (or even in some cases either) of the individual main effects. This occurs frequently when some of the variables involved in the interaction are categorical. The best advice is to fit a model that has all terms significant and to use discipline knowledge rather than an arbitrary rule as an additional guide in model formulation. Generally, a hierarchical model is usually easier to explain to a “customer” that is not familiar

with statistical model-building, but a nonhierarchical model may produce better predictions of new data.

We now illustrate some of the analyses typically associated with fitting a polynomial model in one variable.

Example 7.1 The Hardwood Data

Table 7.1 presents data concerning the strength of kraft paper and the percentage of hardwood in the batch of pulp from which the paper was produced. A scatter diagram of these data is shown in Figure 7.3. This display and knowledge of the production process suggests that a quadratic model may adequately describe the relationship between tensile strength and hardwood concentration. Following the suggestion that centering the data may remove nonessential ill-conditioning, we will fit the model

$$y = \beta_0 + \beta_1(x - \bar{x}) + \beta_2(x - \bar{x})^2 + \varepsilon$$

Since fitting this model is equivalent to fitting a two-variable regression model, we can use the general approach in Chapter 3. The fitted model is

$$\hat{y} = 45.295 + 2.546(x - 7.2632) - 0.635(x - 7.2632)^2$$

The analysis of variance for this model is shown in Table 7.2. The observed value of $F_0 = 79.434$ and the P value is small, so the hypothesis $H_0: \beta_1 = \beta_2 = 0$ is rejected. We

TABLE 7.1 Hardwood Concentration in Pulp and Tensile Strength of Kraft Paper, Example 7.1

Hardwood Concentration, x_i (%)	Tensile Strength, (psi) y_i (psi)
1	6.3
1.5	11.1
2	20.0
3	24.0
4	26.1
4.5	30.0
5	33.8
5.5	34.0
6	38.1
6.5	39.9
7	42.0
8	46.1
9	53.1
10	52.0
11	52.5
12	48.0
13	42.8
14	27.8
15	21.9

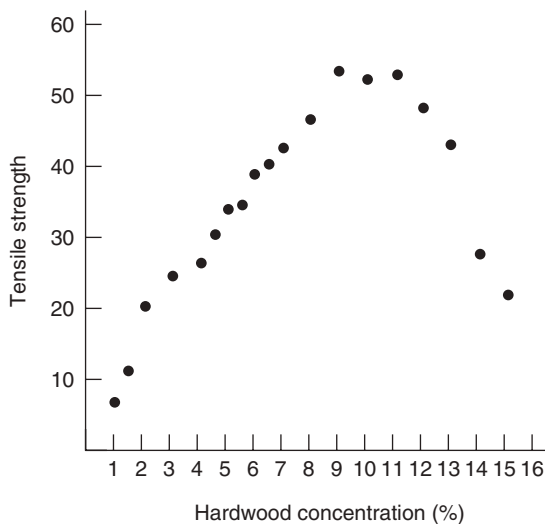

Figure 7.3 Scatterplot of data, Example 7.1.

TABLE 7.2 Analysis of Variance for the Quadratic Model for Example 7.1

Source of Variation	Sum of Squares	Degrees of Freedom	Mean Square	F_0	P Value
Regression	3104.247	2	1552.123	79.434	4.91×10^{-9}
Residual	312.638	16	19.540		
Total	3416.885	18			

conclude that either the linear or the quadratic term (or both) contribute significantly to the model. The other summary statistics for this model are $R^2 = 0.9085$, $se(\hat{\beta}_1) = 0.254$, and $se(\hat{\beta}_2) = 0.062$.

The plot of the residuals versus \hat{y}_i is shown in Figure 7.4. This plot does not reveal any serious model inadequacy. The normal probability plot of the residuals, shown in Figure 7.5, is mildly disturbing, indicating that the error distribution has heavier tails than the normal. However, at this point we do not seriously question the normality assumption.

Now suppose that we wish to investigate the contribution of the quadratic term to the model. That is, we wish to test

$$H_0: \beta_2 = 0, \quad H_1: \beta_2 \neq 0$$

We will test these hypotheses using the extra-sum-of-squares method. If $\beta_2 = 0$, then the reduced model is the straight line $y = \beta_0 + \beta_1(x - \bar{x}) + \varepsilon$. The least-squares fit is

$$\hat{y} = 34.184 + 1.771(x - 7.2632)$$

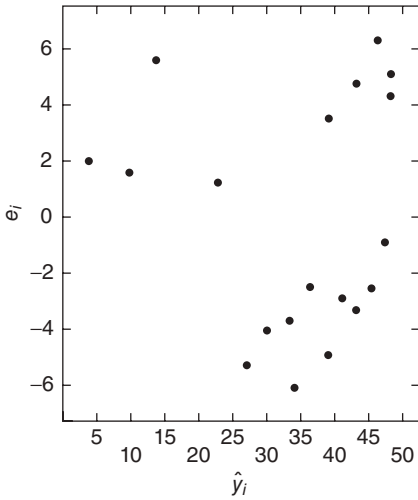

Figure 7.4 Plot of residuals e_i , versus fitted values \hat{y}_i , Example 7.1.

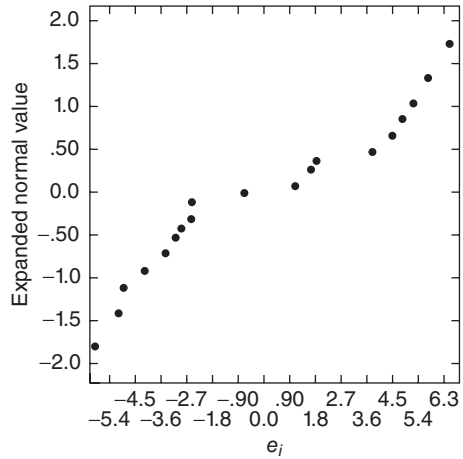

Figure 7.5 Normal probability plot of the residuals, Example 7.1.

The summary statistics for this model are $MS_{Res} = 139.615$, $R^2 = 0.3054$, $se(\hat{\beta}_1) = 0.648$, and $SS_R(\beta_1|\beta_0) = 1043.427$. We note that deleting the quadratic term has substantially affected R^2 , MS_{Res} , and $se(\hat{\beta}_1)$. These summary statistics are much worse than they were for the quadratic model. The extra sum of squares for testing $H_0: \beta_2 = 0$ is

$$\begin{aligned} SS_R(\beta_2|\beta_1, \beta_0) &= SS_R(\beta_1, \beta_2|\beta_0) - SS_R(\beta_1|\beta_0) \\ &= 3104.247 - 1043.427 \\ &= 2060.820 \end{aligned}$$

with one degree of freedom. The F statistic is

$$F_0 = \frac{SS_R(\beta_2|\beta_1, \beta_0)/1}{MS_{Res}} = \frac{2060.820/1}{19.540} = 105.47$$

and since $F_{0.01,1,16} = 8.53$, we conclude that $\beta_2 \neq 0$. Thus, the quadratic term contributes significantly to the model. ■

7.2.2 Piecewise Polynomial Fitting (Splines)

Sometimes we find that a low-order polynomial provides a poor fit to the data, and increasing the order of the polynomial modestly does not substantially improve the situation. Symptoms of this are the failure of the residual sum of squares to stabilize or residual plots that exhibit remaining unexplained structure. This problem may occur when the function behaves differently in different parts of the range of x . Occasionally transformations on x and/or y eliminate this problem. The usual approach, however, is to divide the range of x into segments and fit an appropriate

curve in each segment. **Spline functions** offer a useful way to perform this type of **piecewise polynomial fitting**.

Splines are piecewise polynomials of order k . The joint points of the pieces are usually called **knots**. Generally we require the function values and the first $k - 1$ derivatives to agree at the knots, so that the spline is a continuous function with $k - 1$ continuous derivatives. The **cubic spline** ($k = 3$) is usually adequate for most practical problems.

A cubic spline with h knots, $t_1 < t_2 < \dots < t_h$, with continuous first and second derivatives can be written as

$$E(y) = S(x) = \sum_{j=0}^3 \beta_{0j} x^j + \sum_{i=1}^h \beta_i (x - t_i)_+^3 \quad (7.3)$$

where

$$(x - t_i)_+ = \begin{cases} (x - t_i) & \text{if } x - t_i > 0 \\ 0 & \text{if } x - t_i \leq 0 \end{cases}$$

We assume that the positions of the knots are known. If the knot positions are parameters to be estimated, the resulting problem is a nonlinear regression problem. When the knot positions are known, however, fitting Eq. (7.3) can be accomplished by a straightforward application of linear least squares.

Deciding on the number and position of the knots and the order of the polynomial in each segment is not simple. Wold [1974] suggests that there should be as few knots as possible, with at least four or five data points per segment. Considerable caution should be exercised here because the great flexibility of spline functions makes it very easy to “overfit” the data. Wold also suggests that there should be no more than one extreme point (maximum or minimum) and one point of inflection per segment. Insofar as possible, the extreme points should be centered in the segment and the points of inflection should be near the knots. When prior information about the data-generating process is available, this can sometimes aid in knot positioning.

The basic cubic spline model (7.3) can be easily modified to fit polynomials of different order in each segment and to impose different continuity restrictions at the knots. If all $h + 1$ polynomial pieces are of order 3, then a cubic spline model with no continuity restrictions is

$$E(y) = S(x) = \sum_{j=0}^3 \beta_{0j} x^j + \sum_{i=1}^h \sum_{j=0}^3 \beta_{ij} (x - t_i)_+^j \quad (7.4)$$

where $(x - t)_+^0$ equals 1 if $x > t$ and 0 if $x \leq t$. Thus, if a term $\beta_{ij} (x - t_i)_+^j$ is in the model, this forces a discontinuity at t_i in the j th derivative of $S(x)$. If this term is absent, the j th derivative of $S(x)$ is continuous at t_i . The fewer continuity restrictions required, the better is the fit because more parameters are in the model, while the more continuity restrictions required, the worse is the fit but the smoother the final curve will be. Determining both the order of the polynomial segments and the continuity

restrictions that do not substantially degrade the fit can be done using standard multiple regression hypothesis-testing methods.

As an illustration consider a cubic spline with a single knot at t and no continuity restrictions; for example,

$$E(y) = S(x) = \beta_{00} + \beta_{01}x + \beta_{02}x^2 + \beta_{03}x^3 + \beta_{10}(x-t)_+^0 + \beta_{11}(x-t)_+^1 + \beta_{12}(x-t)_+^2 + \beta_{13}(x-t)_+^3$$

Note that $S(x)$, $S'(x)$, and $S''(x)$ are not necessarily continuous at t because of the presence of the terms involving β_{10} , β_{11} , and β_{12} in the model. To determine whether imposing continuity restrictions reduces the quality of the fit, test the hypotheses $H_0: \beta_{10} = 0$ [continuity of $S(x)$], $H_0: \beta_{10} = \beta_{11} = 0$ [continuity of $S(x)$ and $S'(x)$], and $H_0: \beta_{10} = \beta_{11} = \beta_{12} = 0$ [continuity of $S(x)$, $S'(x)$, and $S''(x)$]. To determine whether the cubic spline fits the data better than a single cubic polynomial over the range of x , simply test $H_0: \beta_{10} = \beta_{11} = \beta_{12} = \beta_{13} = 0$.

An excellent description of this approach to fitting splines is in Smith [1979]. A potential disadvantage of this method is that the $\mathbf{X}'\mathbf{X}$ matrix becomes ill-conditioned if there are a large number of knots. This problem can be overcome by using a different representation of the spline called the **cubic B-spline**. The cubic B-splines are defined in terms of divided differences

$$B_i(x) = \sum_{j=i-4}^i \left[\frac{(x-t_j)_+^3}{\prod_{\substack{m=i-4 \\ m \neq j}}^i (t_j - t_m)} \right], \quad i = 1, 2, \dots, h+4 \tag{7.5}$$

and

$$E(y) = S(x) = \sum_{i=1}^{h+4} \gamma_i B_i(x) \tag{7.6}$$

where γ_i , $i = 1, 2, \dots, h+4$, are parameters to be estimated. In Eq. (7.5) there are eight additional knots, $t_{-3} < t_{-2} < t_{-1} < t_0$ and $t_{h+1} < t_{h+2} < t_{h+3} < t_{h+4}$. We usually take $t_0 = x_{\min}$ and $t_{h+1} = x_{\min}$; the other knots are arbitrary. For further reading on splines, see Buse and Lim [1977], Curry and Schoenberg [1966], Eubank [1988], Gallant and Fuller [1973], Hayes [1970, 1974], Poirier [1973, 1975], and Wold [1974].

Example 7.2 Voltage Drop Data

The battery voltage drop in a guided missile motor observed over the time of missile flight is shown in Table 7.3. The scatterplot in Figure 7.6 suggests that voltage drop behaves differently in different segments of time, and so we will model the data with a cubic spline using two knots at $t_1 = 6.5$ and $t_2 = 13$ seconds after launch, respectively. This placement of knots roughly agrees with course changes by the missile

TABLE 7.3 Voltage Drop Data

Observation, i	Time, x_i (seconds)	Voltage Drop, y_i	Observation, i	Time, x_i (seconds)	Voltage Drop, y_i
1	0.0	8.33	21	10.0	14.48
2	05	823	22	105	14.92
3	1.0	7.17	23	11.0	14.37
4	1.5	7.14	24	11.5	14.63
5	2.0	7.31	25	12.0	15.18
6	2.5	7.60	26	12.5	14.51
7	3.0	7.94	27	13.0	14.34
8	3.5	8.30	28	13.5	13.81
9	4.0	8.76	29	14.0	13.79
10	4.5	8.71	30	14.5	13.05
11	5.0	9.71	31	15.0	13.04
12	5.5	10.26	32	15.5	12.60
13	6.0	10.91	33	16.0	12.05
14	6.5	11.67	34	16.5	11.15
15	7.0	11.76	35	17.0	11.15
16	7.5	12.81	36	17.5	10.14
17	8.0	13.30	37	18.0	10.08
18	8.5	13.88	38	18.5	9.78
19	9.0	14.59	39	19.0	9.80
20	95	14.05	40	19.5	9.95
			41	20.0	9.51

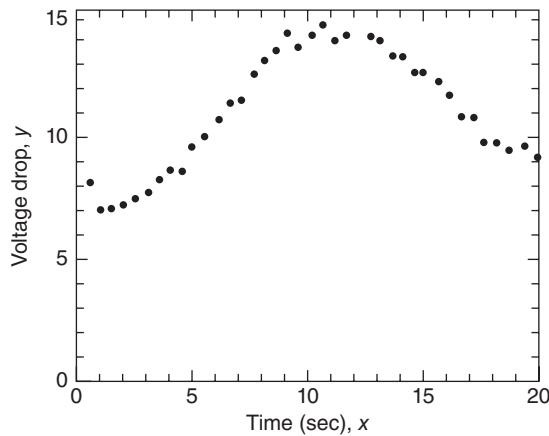

Figure 7.6 Scatterplot of voltage drop data.

(with associated changes in power requirements), which are known from trajectory data. The voltage drop model is intended for use in a digital-analog simulation model of the missile.

The cubic spline model is

$$y = \beta_{00} + \beta_{01}x + \beta_{02}x^2 + \beta_{03}x^3 + \beta_1(x - 6.5)_+^3 + \beta_2(x - 13)_+^3 + \varepsilon$$

TABLE 7.4 Summary Statistics for the Cubic Spline Model of the Voltage Drop Data

Source of Variation	Sum of Squares	Degrees of Freedom	Mean Square	F_0	P Value
Regression	260.1784	5	52.0357	725.52	<0.0001
Residual	2.5102	35	0.0717		
Total	262.6886	40			

Parameter	Estimate	Standard Error	t Value for $H_0: \beta = 0$	P Value
β_{00}	8.4657	0.2005	42.22	<0.0001
β_{01}	-1.4531	0.1816	-8.00	<0.0001
β_{02}	0.4899	0.0430	11.39	<0.0001
β_{03}	-0.0295	0.0028	-10.54	<0.0001
β_1	0.0247	0.0040	6.18	<0.0001
β_2	0.0271	0.0036	7.53	<0.0001

$$R_2 = 0.9904$$

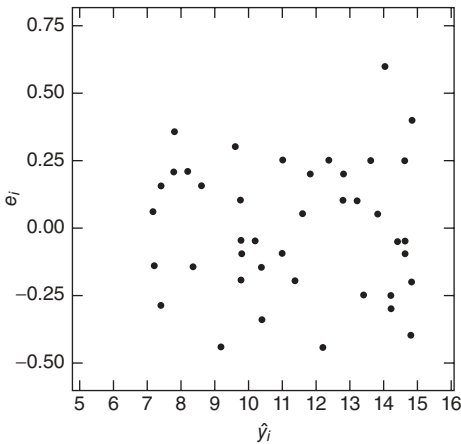

Figure 7.7 Plot of residuals e_i , versus fitted values \hat{y}_i for the cubic spline model.

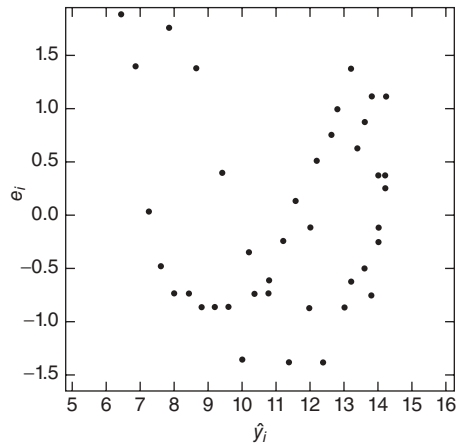

Figure 7.8 Plot of residuals e_i , versus fitted values \hat{y}_i for the cubic polynomial model.

and the least-squares fit is

$$\hat{y} = 8.4657 - 1.4531x + 0.4899x^2 - 0.0295x^3 + 0.0247(x - 6.5)_+^3 + 0.0271(x - 13)_+^3$$

The model summary statistics are displayed in Table 7.4. A plot of the residuals versus \hat{y} is shown in Figure 7.7. This plot (and other residual plots) does not reveal any serious departures from assumptions, so we conclude that the cubic spline model is an adequate fit to the voltage drop data. ■

We may easily compare the cubic spline model fit from Example 7.2 with a sample cubic polynomial over the entire time of missile flight; for example,

$$\hat{y} = 6.4910 + 0.7032x + 0.0340x^2 - 0.0033x^3$$

This is a simpler model containing fewer parameters and would be preferable to the cubic spline model if it provided a satisfactory fit. The residuals from this cubic polynomial are plotted versus \hat{y} in Figure 7.8. This plot exhibits strong indication of curvature, and on the basis of this remaining unexplained structure we conclude that the simple cubic polynomial is an inadequate model for the voltage drop data.

We may also investigate whether the cubic spline model improves the fit by testing the hypothesis $H_0: \beta_1 = \beta_2 = 0$ using the extra-sum-of-squares method. The regression sum of squares for the cubic polynomial is

$$SS_R(\beta_{01}, \beta_{02}, \beta_{03} | \beta_{00}) = 230.4444$$

with three degrees of freedom. The extra sum of squares for testing $H_0: \beta_1 = \beta_2 = 0$ is

$$\begin{aligned} SS_R(\beta_1, \beta_2 | \beta_{00}, \beta_{01}, \beta_{02}, \beta_{03}) &= SS_R(\beta_{01}, \beta_{02}, \beta_{03}, \beta_2, \beta_2 | \beta_{00}) - SS_R(\beta_{01}, \beta_{02}, \beta_{03} | \beta_{00}) \\ &= 260.1784 - 230.4444 \\ &= 29.7340 \end{aligned}$$

with two degrees of freedom. Since

$$F_0 = \frac{SS_R(\beta_1, \beta_2 | \beta_{00}, \beta_{01}, \beta_{02}, \beta_{03})/2}{MS_{\text{Res}}} = \frac{29.7340/2}{0.0717} = 207.35$$

which would be referred to the $F_{2, 35}$ distribution, we reject the hypothesis that $H_0: \beta_1 = \beta_2 = 0$. We conclude that the cubic spline model provides a better fit.

Example 7.3 Piecewise Linear Regression

An important special case of practical interest involves fitting piecewise linear regression models. This can be treated easily using **linear splines**. For example, suppose that there is a single knot at t and that there could be both a slope change and a discontinuity at the knot. The resulting linear spline model is

$$E(y) = S(x) = \beta_{00} + \beta_{01}x + \beta_{10}(x-t)_+^0 + \beta_{11}(x-t)_+^1$$

Now if $x \leq t$, the straight-line model is

$$E(y) = \beta_{00} + \beta_{01}x$$

and if $x > t$, the model is

$$\begin{aligned} E(y) &= \beta_{00} + \beta_{01}x + \beta_{10}(1) + \beta_{11}(x-t) \\ &= (\beta_{00} + \beta_{10} - \beta_{11}t) + (\beta_{01} + \beta_{11})x \end{aligned}$$

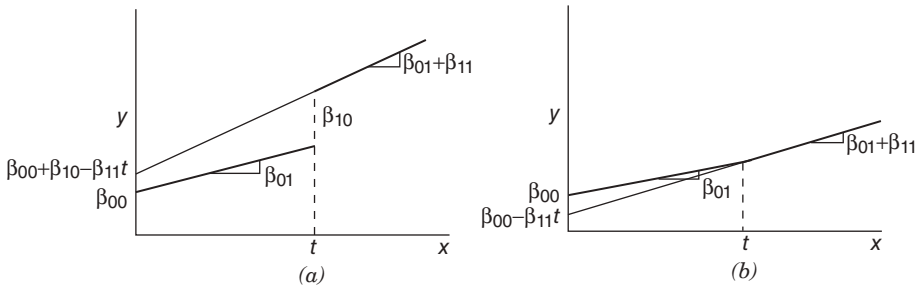

Figure 7.9 Piecewise linear regression: (a) discontinuity at the knot; (b) continuous piecewise linear regression model.

That is, if $x \leq t$, the model has intercept β_{00} and slope β_{01} , while if $x > t$, the intercept is $\beta_{00} + \beta_{10} - \beta_{11}t$ and the slope is $\beta_{01} + \beta_{11}$. The regression function is shown in Figure 7.9a. Note that the parameter β_{10} represents the difference in mean response at the knot t .

A smoother function would result if we required the regression function to be continuous at the knot. This is easily accomplished by deleting the term $\beta_{10}(x-t)_+$ from the original model, giving

$$E(y) = S(x) = \beta_{00} + \beta_{01}x + \beta_{11}(x-t)_+^1$$

Now if $x \leq t$, the model is

$$E(y) = \beta_{00} + \beta_{01}x$$

and if $x > t$, the model is

$$\begin{aligned} E(y) &= \beta_{00} + \beta_{01}x + \beta_{11}(x-t) \\ &= (\beta_{00} - \beta_{11}t) + (\beta_{01} + \beta_{11})x \end{aligned}$$

The two regression functions are shown in Figure 7.9b. ■

7.2.3 Polynomial and Trigonometric Terms

It is sometimes useful to consider models that combine both polynomial and trigonometric terms as alternatives to models that contain polynomial terms only. In particular, if the scatter diagram indicates that there may be some periodicity or cyclic behavior in the data, adding trigonometric terms to the model may be very beneficial, in that a model with fewer terms may result than if only polynomial terms were employed. This benefit has been noted by both Graybill [1976] and Eubank and Speckman [1990].

The model for a single regressor x is

$$y = \beta_0 + \sum_{i=1}^d \beta_i x^i + \sum_{j=1}^r [\delta_j \sin(jx) + \gamma_j \cos(jx)] + \epsilon$$

If the regressor x is equally spaced, then the pairs of terms $\sin(jx)$ and $\cos(jx)$ are orthogonal. Even without exactly equal spacing, the correlation between these terms will usually be quite small.

Eubank and Speckman [1990] use the voltage drop data of Example 7.2 to illustrate fitting a polynomial-trigonometric regression model. They first rescale the regressor x (time) so that all of the observations are in the interval $(0, 2\pi)$ and fit the model above with $d = 2$ and $r = 1$ so that the model is quadratic in time and has a pair of sine-cosine terms. Thus, their model has only four terms, whereas our spline regression model had five. Eubank and Speckman obtain $R^2 = 0.9895$ and $MS_{\text{Res}} = 0.0767$, results that are very similar to those found for the spline model (refer to Table 7.4). Since the voltage drop data exhibited some indication of periodicity in the scatterplot (Figure 7.6), the polynomial-trigonometric regression model is certainly a good alternative to the spline model. It has one fewer term (always a desirable property) but a slightly larger residual mean square. Working with a rescaled version of the regressor variable might also be considered a potential disadvantage by some users.

7.3 NONPARAMETRIC REGRESSION

Closely related to piecewise polynomial regression is **nonparametric regression**. The basic idea of nonparametric regression is to develop a **model-free** basis for predicting the response over the range of the data. The early approaches to nonparametric regression borrow heavily from nonparametric density estimation. Most of the nonparametric regression literature focuses on a single regressor; however, many of the basic ideas extend to more than one.

A fundamental insight to nonparametric regression is the nature of the predicted value. Consider standard ordinary least squares. Recall

$$\begin{aligned}\hat{\mathbf{y}} &= \mathbf{X}\hat{\boldsymbol{\beta}} = \mathbf{X}(\mathbf{X}'\mathbf{X})^{-1}\mathbf{X}'\mathbf{y} \\ &= \mathbf{H}\mathbf{y} \\ &= \begin{bmatrix} h_{11} & h_{12} & \dots & h_{1n} \\ h_{21} & h_{22} & \dots & h_{2n} \\ \vdots & \vdots & \ddots & \vdots \\ h_{n1} & h_{n2} & \dots & h_{nn} \end{bmatrix} \begin{bmatrix} y_1 \\ y_2 \\ \vdots \\ y_n \end{bmatrix}\end{aligned}$$

As a result,

$$\hat{y}_i = \sum_{j=1}^n h_{ij}y_j$$

In other words, the predicted value for the i th response is simply a linear combination of the original data.

7.3.1 Kernel Regression

One of the first alternative nonparametric approaches is the **kernel** smoother, which uses a weighted average of the data. Let \tilde{y}_i be the kernel smoother estimate of the i th response. For a kernel smoother,

$$\tilde{y}_i = \sum_{j=1}^n w_{ij} y_j$$

where $\sum_{j=1}^n w_{ij} = 1$. As a result,

$$\mathbf{y} = \mathbf{S}\mathbf{y}$$

where $\mathbf{S} = [w_{ij}]$ is the “smoothing” matrix. Typically, the weights are chosen such that $w_{ij} \equiv 0$ for all y_j 's outside of a defined “neighborhood” of the specific location of interest. These kernel smoothers use a bandwidth, b , to define this neighborhood of interest. A large value for b results in more of the data being used to predict the response at the specific location. Consequently, the resulting plot of predicted values becomes much smoother as b increases. Conversely, as b decreases, less of the data are used to generate the prediction, and the resulting plot looks more “wiggly” or bumpy.

This approach is called a kernel smoother because it uses a kernel function, K , to specify the weights. Typically, these kernel functions have the following properties:

- $K(t) \geq 0$ for all t
- $\int_{-\infty}^{\infty} K(t) dt = 1$
- $K(-t) = K(t)$ (symmetry)

These are also the properties of a symmetric probability density function, which emphasizes the relationship back to nonparametric density estimation. The specific weights for the kernel smoother are given by

$$w_{ij} = \frac{K\left(\frac{x_i - x_j}{b}\right)}{\sum_{k=1}^n K\left(\frac{x_i - x_k}{b}\right)}$$

Table 7.5 summarizes the kernels used in S-PLUS. The properties of the kernel smoother depend much more on the choice of the bandwidth than the actual kernel function.

7.3.2 Locally Weighted Regression (Loess)

Another nonparametric alternative is **locally weighted regression**, often called **loess**. Like kernel regression, loess uses the data from a neighborhood around the specific

TABLE 7.5 Summary of the Kernel Functions Used in S-PLUS

Box	$K(t) = \begin{cases} 1, & t \leq 0.5 \\ 0, & t > 0.5 \end{cases}$
Triangle	$K(t) = \begin{cases} 1 - \frac{ t }{c}, & t \leq \frac{1}{c} \\ 0, & t > \frac{1}{c} \end{cases}$
Parzen	$K(t) = \begin{cases} \frac{k_1 - t^2}{k^2}, & t \leq C_1 \\ \frac{t^2}{k_3} - k_4 t + k_5, & C_1 < t \leq C_2 \\ 0, & t > C_2 \end{cases}$
Normal	$K(t) = \frac{1}{\sqrt{2\pi k_6}} \exp\left\{\frac{-t^2}{2k_6^2}\right\}$

location. Typically, the neighborhood is defined as the **span**, which is the fraction of the total points used to form neighborhoods. A span of 0.5 indicates that the closest half of the total data points is used as the neighborhood. The loess procedure then uses the points in the neighborhood to generate a weighted least-squares estimate of the specific response. The weighted least-squares procedure uses a low-order polynomial, usually simple linear regression or a quadratic regression model. The weights for the weighted least-squares portion of the estimation are based on the distance of the points used in the estimation from the specific location of interest. Most software packages use the **tri-cube** weighting function as its default. Let x_0 be the specific location of interest, and let $\Delta(x_0)$ be the distance the farthest point in the neighborhood lies from the specific location of interest. The tri-cube weight function is

$$W\left[\frac{|x_0 - x_j|}{\Delta(x_0)}\right]$$

where

$$W(t) = \begin{cases} (1 - t^3)^3 & \text{for } 0 \leq t < 1 \\ 0 & \text{elsewhere} \end{cases}$$

We can summarize the loess estimation procedure by

$$\mathbf{y} = \mathbf{S}\mathbf{y}$$

where \mathbf{S} is the smoothing matrix created by the locally weighted regression.

The concept of sum of squared residuals carries over to nonparametric regression directly. In particular,

$$\begin{aligned}
SS_{\text{Res}} &= \sum_{i=1}^n (y_i - \tilde{y}_i)^2 \\
&= (\mathbf{y} - \mathbf{S}\mathbf{y})'(\mathbf{y} - \mathbf{S}\mathbf{y}) \\
&= \mathbf{y}'[\mathbf{I} - \mathbf{S}'][\mathbf{I} - \mathbf{S}]\mathbf{y} \\
&= \mathbf{y}'[\mathbf{I} - \mathbf{S}' - \mathbf{S} + \mathbf{S}'\mathbf{S}]\mathbf{y}
\end{aligned}$$

Asymptotically, these smoothing procedures are unbiased. As a result, the asymptotic expected value for SS_{Res} is

$$\begin{aligned}
&\text{trace}[(\mathbf{I} - \mathbf{S}' - \mathbf{S} + \mathbf{S}'\mathbf{S})\sigma^2\mathbf{I}] \\
&= \sigma^2\text{trace}[\mathbf{I} - \mathbf{S}' - \mathbf{S} + \mathbf{S}'\mathbf{S}] \\
&= \sigma^2/[\text{trace}(\mathbf{I}) - \text{trace}(\mathbf{S}') - \text{trace}(\mathbf{S}) + \text{trace}(\mathbf{S}'\mathbf{S})]
\end{aligned}$$

It is important to note that \mathbf{S} is a square $n \times n$ matrix. As a result, $\text{trace}[\mathbf{S}'] = \text{trace}[\mathbf{S}]$; thus,

$$E(SS_{\text{Res}}) = \sigma^2[n - 2 \text{trace}(\mathbf{S}) + \text{trace}(\mathbf{S}'\mathbf{S})]$$

In some sense, $[2 \text{trace}(\mathbf{S}) - \text{trace}(\mathbf{S}'\mathbf{S})]$ represents the degrees of freedom associated with the total model. In some packages, $[2 \text{trace}(\mathbf{S}) - \text{trace}(\mathbf{S}'\mathbf{S})]$ is called the equivalent number of parameters and represents a measure of the complexity of the estimation procedure. A common estimate of σ^2 is

$$\tilde{\sigma}^2 = \frac{\sum_{i=1}^n (y_i - \tilde{y}_i)^2}{n - 2 \text{trace}(\mathbf{S}) + \text{trace}(\mathbf{S}'\mathbf{S})}$$

Finally, we can define a version of R^2 by

$$R^2 = \frac{SS_{\text{T}} - SS_{\text{Res}}}{SS_{\text{T}}}$$

whose interpretation is the same as before in ordinary least squares. All of this extends naturally to the multiple regression case, and S-PLUS has this capability.

Example 7.4 Applying Loess Regression to the Windmill Data

In Example 5.2, we discussed the data collected by an engineer who investigated the relationship of wind velocity and the DC electrical output for a windmill. Table 5.5 summarized these data. Ultimately in this example, we developed a simple linear regression model involving the inverse of the wind velocity. This model provided a nice basis for modeling the fact that there is a true upper bound to the DC output the windmill can generate.

An alternative approach to this example uses loess regression. The appropriate SAS code to analyze the windmill data is:

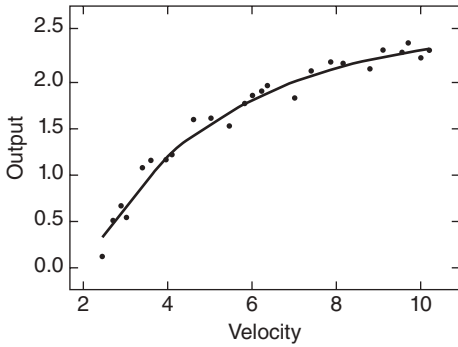

Figure 7.10 The loess fit to the windmill data.

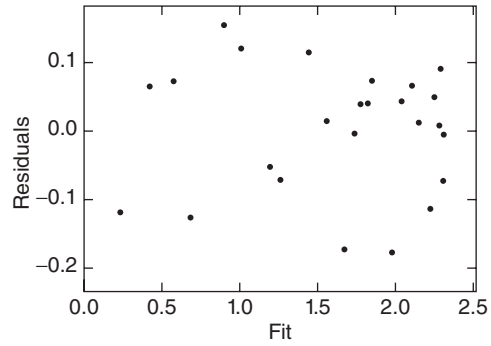

Figure 7.11 The residuals versus fitted values for the loess fit to the windmill data.

TABLE 7.6 SAS Output for Loess Fit to Windmill Data

The LOESS Procedure
 Selected Smoothing Parameter: 0.78
 Dependent Variable: output

Fit Summary	
Fit Method	kd Tree
Blending	Linear
Number of Observations	25
Number of Fitting Points	10
kd Tree Bucket Size	3
Degree of Local Polynomials	2
Smoothing Parameter	0.78000
Points in Local Neighborhood	19
Residual Sum of Squares	0.22112
Trace[L]	4.56199
GCV	0.00052936
AICC	-3.12460
AICC1	-77.85034
Delta1	20.03324
Delta2	19.70218
Equivalent Number of Parameters	4.15723
Lookup Degrees of Freedom	20.36986
Residual Standard Error	0.10506

```
proc loess;
model output = velocity / degree = 2 dfmethod = exact
residual;
```

Figure 7.10 gives the loess fit to the data using SAS’s default settings, and Table 7.6 summarizes the resulting SAS report. Figure 7.11, which gives the residuals versus fitted values, shows no real problems. Figure 7.12 gives the normal probability plot, which, although not perfect, does not indicate any serious problems.

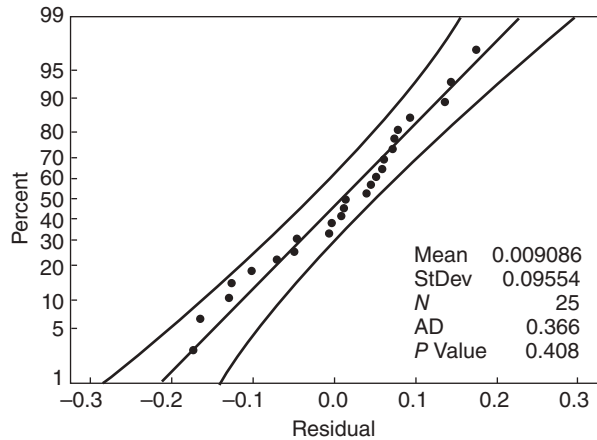

Figure 7.12 The normal probability plot of the residuals for the loess fit to the windmill data.

The loess fit to the data is quite good and compares favorably with the fit we generated earlier using ordinary least squares and the inverse of the wind velocity.

The report indicates an R^2 of 0.98, which is the same as our final simple linear regression model. Although the two R^2 values are not directly comparable, they both indicate a very good fit. The loess MS_{Res} is 0.1017, compared to a value of 0.0089 for the simple linear regression model. Clearly, both models are competitive with one another. Interestingly, the loess fit requires an equivalent number of parameters of 4.4, which is somewhere between a cubic and quartic model. On the other hand, the simple linear model using the inverse of the wind velocity requires only two parameters; hence, it is a much simpler model. Ultimately, we prefer the simple linear regression model since it is simpler and corresponds to known engineering theory. The loess model, on the other hand, is more complex and somewhat of a “black box.” ■

The R code to perform the analysis of these data is:

```
windmill <- read.table("windmill_loess.txt", header=TRUE,
sep=" ") wind.model <- loess(output~velocity,
data=windmill)
summary(wind.model)
yhat <- predict(wind.model)
plot(windmill$velocity,yhat)
```

7.3.3 Final Cautions

Parametric and nonparametric regression analyses each have their advantages and disadvantages. Often, parametric models are guided by appropriate subject area theory. Nonparametric models almost always reflect pure empiricism.

One should always prefer a simple parametric model when it provides a reasonable and satisfactory fit to the data. The complexity issue is not trivial. Simple models provide an easy and convenient basis for prediction. In addition, the model terms often have important interpretations. There are situations, like the windmill data, where transformations of either the response or the regressor are required to provide an appropriate fit to the data. Again, one should prefer the parametric model, especially when subject area theory supports the transformation used.

On the other hand, there are many situations where no simple parametric model yields an adequate or satisfactory fit to the data, where there is little or no subject area theory to guide the analyst, and where no simple transformation appears appropriate. In such cases, nonparametric regression makes a great deal of sense. One is willing to accept the relative complexity and the black-box nature of the estimation in order to give an adequate fit to the data.

7.4 POLYNOMIAL MODELS IN TWO OR MORE VARIABLES

Fitting a polynomial regression model in two or more regressor variables is a straightforward extension of the approach in Section 7.2.1. For example, a second-order polynomial model in two variables would be

$$y = \beta_0 + \beta_1 x_1 + \beta_2 x_2 + \beta_{11} x_1^2 + \beta_{22} x_2^2 + \beta_{12} x_1 x_2 + \varepsilon \quad (7.7)$$

Note that this model contains two linear effect parameters β_1 and β_2 two quadratic effect parameters β_{11} and β_{21} and an interaction effect parameter β_{12} .

Fitting a second-order model such as Eq. (7.7) has received considerable attention, both from researchers and from practitioners. We usually call the regression function

$$E(y) = \beta_0 + \beta_1 x_1 + \beta_2 x_2 + \beta_{11} x_1^2 + \beta_{22} x_2^2 + \beta_{12} x_1 x_2$$

a **response surface**. We may represent the two-dimensional response surface graphically by drawing the x_1 and x_2 axes in the plane of the paper and visualizing the $E(y)$ axis perpendicular to the plane of the paper. Plotting contours of constant expected response $E(y)$ produces the response surface. For example, refer to Figure 3.3, which shows the response surface

$$E(y) = 800 + 10x_1 + 7x_2 - 8.5x_1^2 - 5x_2^2 + 4x_1x_2$$

Note that this response surface is a hill, containing a point of maximum response. Other possibilities include a valley containing a point of minimum response and a saddle system. **Response surface methodology** (RSM) is widely applied in industry for modeling the output response(s) of a process in terms of the important controllable variables and then finding the operating conditions that optimize the response. For a detailed treatment of response surface methods see Box and Draper [1987], Box, Hunter, and Hunter [1978], Khuri and Cornell [1996], Montgomery [2009], and Myers, Montgomery and Anderson Cook [2009].

We now illustrate fitting a second-order response surface in two variables. Panel A of Table 7.7 presents data from an experiment that was performed to study the

effect of two variables, reaction temperature (T) and reactant concentration (C), on the percent conversion of a chemical process (y). The process engineers had used an approach to improving this process based on **designed experiments**. The first experiment was a screening experiment involving several factors that isolated temperature and concentration as the two most important variables. Because the experimenters thought that the process was operating in the vicinity of the optimum, they elected to fit a quadratic model relating yield to temperature and concentration.

Panel A of Table 7.7 shows the levels used for T and C in the natural units of measurements. Panel B shows the levels in terms of coded variables x_1 and x_2 .

Figure 7.13 shows the experimental design in Table 7.5 graphically. This design is called a **central composite design**, and it is widely used for fitting a second-order

TABLE 7.7 Central Composite Design for Chemical Process Example

Observation	Run Order	A		B		y
		Temperature ($^{\circ}\text{C}$) T	Cone. (%) C	x_1	x_2	
1	4	200	15	-1	-1	43
2	12	250	15	1	-1	78
3	11	200	25	-1	1	69
4	5	250	25	1	1	73
5	6	189.65	20	-1.414	0	48
6	7	260.35	20	1.414	0	76
7	1	225	12.93	0	-1.414	65
8	3	225	27.07	0	1.414	74
9	8	225	20	0	0	76
10	10	225	20	0	0	79
11	9	225	20	0	0	83
12	2	225	20	0	0	81

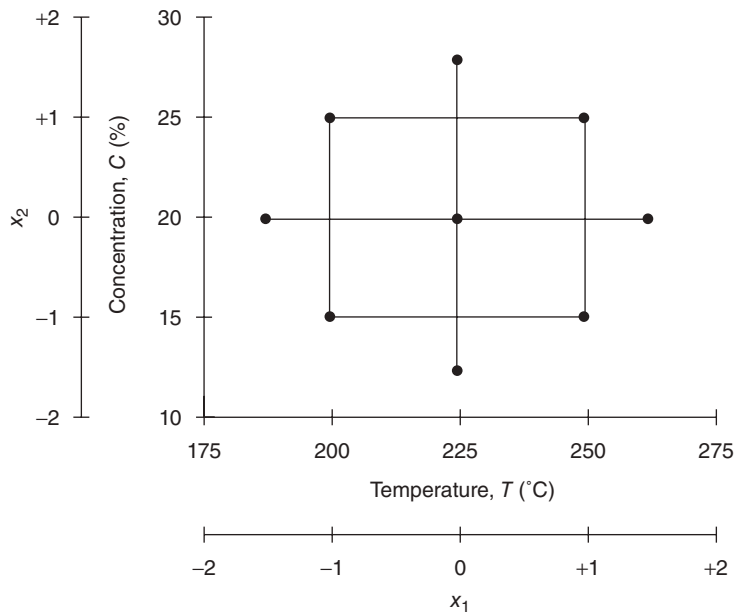

Figure 7.13 Central composite design for the chemical process example.

response surface. Notice that the design consists of four runs at the corners of a square plus four runs at the center of this square plus four axial runs. In terms of the coded variables the corners of the square are $(x_1, x_2) = (-1, -1), (1, -1), (-1, 1), (1, 1)$; the center points are at $(x_1, x_2) = (0, 0)$; and the axial runs are at $(x_1, x_2) = (-1.414, 0), (1.414, 0), (0, -1.414), (0, 1.414)$.

We fit the second-order model

$$y = \beta_0 + \beta_1 x_1 + \beta_2 x_2 + \beta_{11} x_1^2 + \beta_{22} x_2^2 + \beta_{12} x_1 x_2 + \varepsilon$$

using the coded variables, as that is the standard practice in RSM work. The \mathbf{X} matrix and \mathbf{y} vector for this model are

$$\mathbf{X} = \begin{matrix} & x_1 & x_2 & x_1^2 & x_2^2 & x_1 x_2 \\ \begin{matrix} 1 \\ 1 \\ 1 \\ 1 \\ 1 \\ 1 \\ 1 \\ 1 \\ 1 \\ 1 \\ 1 \\ 1 \\ 1 \\ 1 \\ 1 \end{matrix} & \begin{bmatrix} -1 & -1 & 1 & 1 & 1 \\ 1 & -1 & 1 & 1 & -1 \\ 1 & 1 & 1 & 1 & 1 \\ 1 & 1 & 1 & 1 & 1 \\ -1.414 & 0 & 2 & 0 & 0 \\ 1.414 & 0 & 2 & 0 & 0 \\ 0 & -1.414 & 0 & 2 & 0 \\ 0 & 1.414 & 0 & 2 & 0 \\ 0 & 0 & 0 & 0 & 0 \\ 0 & 0 & 0 & 0 & 0 \\ 0 & 0 & 0 & 0 & 0 \\ 0 & 0 & 0 & 0 & 0 \\ 0 & 0 & 0 & 0 & 0 \\ 0 & 0 & 0 & 0 & 0 \\ 0 & 0 & 0 & 0 & 0 \end{bmatrix} & \mathbf{y} = \begin{bmatrix} 43 \\ 78 \\ 69 \\ 73 \\ 48 \\ 76 \\ 65 \\ 74 \\ 76 \\ 79 \\ 83 \\ 81 \end{bmatrix} \end{matrix}$$

Notice that we have shown the variables associated with each column above that column in the \mathbf{X} matrix. The entries in the columns associated with x_1^2 and x_2^2 are found by squaring the entries in columns x_1 and x_2 , respectively, and the entries in the $x_1 x_2$ column are found by multiplying each entry from x_1 by the corresponding entry from x_2 . The $\mathbf{X}'\mathbf{X}$ matrix and $\mathbf{X}'\mathbf{y}$ vector are

$$\mathbf{X}'\mathbf{X} = \begin{bmatrix} 12 & 0 & 0 & 8 & 8 & 0 \\ 0 & 8 & 0 & 0 & 0 & 0 \\ 0 & 0 & 8 & 0 & 0 & 0 \\ 8 & 0 & 0 & 12 & 4 & 0 \\ 8 & 0 & 0 & 4 & 12 & 0 \\ 0 & 0 & 0 & 0 & 0 & 4 \end{bmatrix}, \quad \mathbf{X}'\mathbf{y} = \begin{bmatrix} 845.000 \\ 78.592 \\ 33.726 \\ 511.000 \\ 541.000 \\ -31.000 \end{bmatrix}$$

and from $\hat{\boldsymbol{\beta}} = (\mathbf{X}'\mathbf{X})^{-1} \mathbf{X}'\mathbf{y}$ we obtain

TABLE 7.8 Analysis of Variance for the Chemical Process Example

Source of Variation	Sum of Squares	Degrees of Freedom	Mean Square	F_0	P Value
Regression	1733.6	5	346.71	58.86	<0.0001
$SS_R(\beta_1, \beta_2 \beta_0)$	(914.4)	(2)	(457.20)		
$SS_R(\beta_{11}, \beta_{22}, \beta_{12} \beta_0, \beta_1, \beta_2)$	(819.2)	(3)	(273.10)		
Residual	35.3	6	5.89		
Lack of fit	(8.5)	(3)	(2.83)	0.3176	0.8120
Pure error	(26.8)	(3)	(8.92)		
Total	1768.9	11			
$R^2 = 0.9800$		$R_{\text{adj}}^2 = 0.9634$		PRESS = 108.7	

$$\hat{\beta} = \begin{bmatrix} 79.75 \\ 9.83 \\ 4.22 \\ -8.88 \\ -5.13 \\ -7.75 \end{bmatrix}$$

Therefore, the fitted model for percent conversion is

$$\hat{y} = 79.75 + 9.83x_1 + 4.22x_2 - 8.88x_1^2 - 5.13x_2^2 - 7.75x_1x_2$$

In terms of the natural variables, the model is

$$\hat{y} = -1105.56 + 8.0242T + 22.994C + 0.0142T^2 + 0.20502C^2 + 0.062TC$$

Table 7.8 shows the analysis of variance for this model. Because the experimental design has four replicate runs, the residual sum of squares can be partitioned into pure-error and lack-of-fit components. The lack-of-fit test in Table 7.8 is testing the lack of fit for the quadratic model. The P value for this test is large ($P = 0.8120$), implying that the quadratic model is adequate. Therefore, the residual mean square with six degrees of freedom is used for the remaining analysis. The F test for significance of regression is $F_0 = 58.86$; and because the P value is very small, we would reject the hypothesis $H_0: \beta_1 = \beta_2 = \beta_{11} = \beta_{22} = \beta_{12} = 0$, concluding that at least some of these parameters are nonzero. This table also shows the sum of squares for testing the contribution of only the linear terms to the model [$SS_R(\beta_1, \beta_2|\beta_0) = 918.4$ with two degrees of freedom] and the sum of squares for testing the contribution of the quadratic terms given that the model already contains the linear terms [$SS_R(\beta_{11}, \beta_{22}, \beta_{12}|\beta_0, \beta_1, \beta_2) = 819.2$ with three degrees of freedom]. Comparing both of the corresponding mean squares to the residual mean square gives the following F statistics

TABLE 7.9 Tests on the Individual Variables, Chemical Process Quadratic Model

Variable	Coefficient Estimate	Standard Error	t for H_0 Coefficient = 0	P Value
Intercept	79.75	1.21	65.72	
x_1	9.83	0.86	11.45	0.0001
x_2	4.22	0.86	4.913	0.0027
x_1^2	-8.88	0.96	-9.250	0.0001
x_2^2	-5.13	0.96	-5.341	0.0018
x_1x_2	-7.75	1.21	-6.386	0.0007

$$F_0 = \frac{SS_R(\beta_1, \beta_2 | \beta_0)/2}{MS_{Res}} = \frac{914.4/2}{5.89} = \frac{457.2}{5.89} = 77.62$$

for which $P = 5.2 \times 10^{-5}$ and

$$F_0 = \frac{SS_R(\beta_{11}, \beta_{22}, \beta_{12} | \beta_0, \beta_1, \beta_2)/3}{MS_{Res}} = \frac{819.2/3}{5.89} = \frac{273.1}{5.89} = 46.37$$

for which $P = 0.0002$. Therefore, both the linear and quadratic terms contribute significantly to the model.

Table 7.9 shows t tests on each individual variable. All t values are large enough for us to conclude that there are no nonsignificant terms in the model. If some of these t statistics had been small, some analysts would drop the nonsignificant variables for the model, resulting in a reduced quadratic model for the process. Generally, we prefer to fit the full quadratic model whenever possible, unless there are large differences between the full and reduced model in terms of PRESS and adjusted R^2 . Table 7.8 indicates that the R^2 and adjusted R^2 values for this model are satisfactory. $R^2_{\text{prediction}}$, based on PRESS, is

$$R^2_{\text{prediction}} = 1 - \frac{\text{PRESS}}{SS_T} = 1 - \frac{108.7}{1768.9} = 0.9385$$

indicating that the model will probably explain a high percentage (about 94%) of the variability in new data.

Table 7.10 contains the observed and predicted values of percent conversion, the residuals, and other diagnostic statistics for this model. None of the studentized residuals or the values of R -student are large enough to indicate any potential problem with outliers. Notice that the hat diagonals h_{ii} take on only two values, either 0.625 or 0.250. The values of $h_{ii} = 0.625$ are associated with the four runs at the corners of the square in the design and the four axial runs. All eight of these points are equidistant from the center of the design; this is why all of the h_{ii} values are identical. The four center points all have $h_{ii} = 0.250$. Figures 7.14, 7.15, and 7.16 show a normal probability plot of the studentized residuals, a plot of the studentized residuals versus the predicted values \hat{y}_i , and a plot of the studentized residuals versus run order. None of these plots reveal any model inadequacy.

TABLE 7.10 Observed Values, Predicted Values, Residuals, and Other Diagnostics for the Chemical Process Example

Observed Value	Actual Value	Predicted Value	Residual	h_{ii}	Studentized Residual	Cook's D	R -Student
1	43.00	43.96	-0.96	0.625	-0.643	0.115	-0.609
2	78.00	79.11	-1.11	0.625	-0.745	0.154	-0.714
3	69.00	67.89	1.11	0.625	0.748	0.155	0.717
4	73.00	72.04	0.96	0.625	0.646	0.116	0.612
5	48.00	48.11	-0.11	0.625	-0.073	0.001	-0.067
6	76.00	75.90	0.10	0.625	-0.073	0.001	-0.067
7	65.00	63.54	1.46	0.625	0.982	0.268	0.979
8	74.00	75.46	-1.46	0.625	-0.985	0.269	-0.982
9	76.00	79.75	-3.75	0.250	-1.784	0.177	-2.377
10	79.00	79.75	-0.75	0.250	-0.357	0.007	-0.329
11	83.00	79.75	3.25	0.250	1.546	0.133	1.820
12	81.00	79.75	1.25	0.250	0.595	0.020	0.560

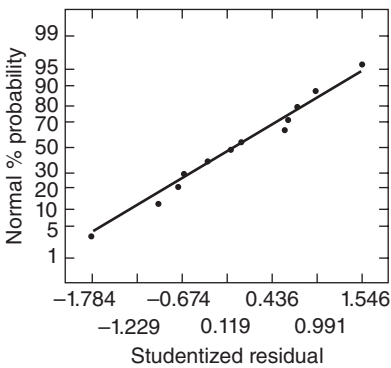

Figure 7.14 Normal probability plot of the studentized residuals, chemical process example.

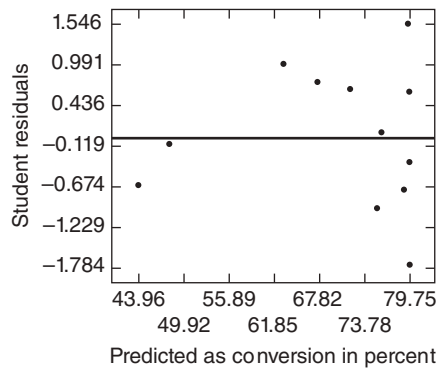

Figure 7.15 Plot of studentized residuals versus predicted conversion, chemical process example.

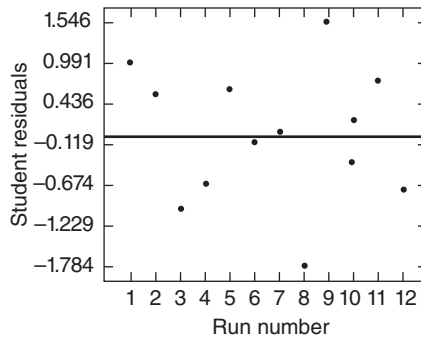

Figure 7.16 Plot of the studentized residuals run order, chemical process example.

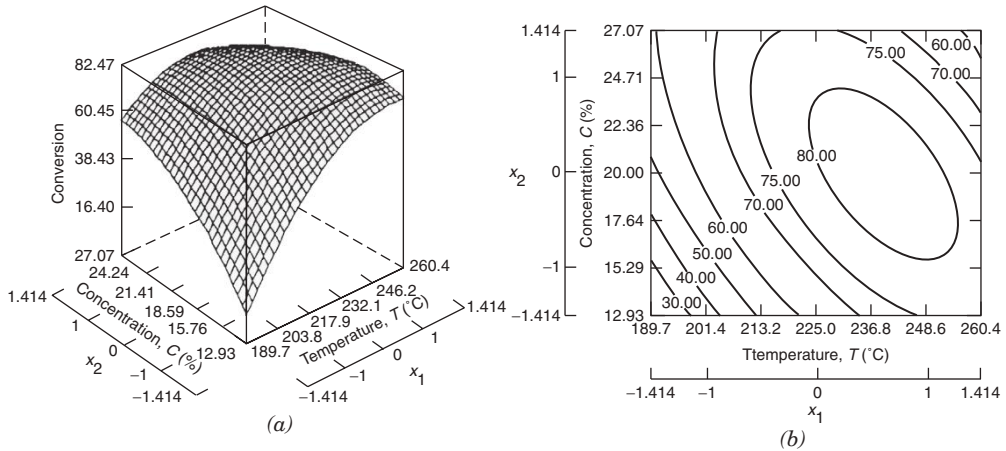

Figure 7.17 (a) Response surface of predicted conversion. (b) Contour plot of predicted conversion.

Plots of the conversion response surface and the contour plot, respectively, for the fitted model are shown in panels *a* and *b* of Figure 7.17. The response surface plots indicate that the maximum percent conversion occurs at about 245°C and 20% concentration.

In many response surface problems the experimenter is interested in predicting the response y or estimating the mean response at a particular point in the process variable space. The response surface plots in Figure 7.17 give a graphical display of these quantities. Typically, the variance of the prediction is also of interest, because this is a direct measure of the likely error associated with the point estimate produced by the model. Recall that the variance of the estimate of the mean response at the point \mathbf{x}_0 is given by $\text{Var}[\hat{y}(\mathbf{x}_0)] = \sigma^2 \mathbf{x}_0' (\mathbf{X}'\mathbf{X})^{-1} \mathbf{x}_0$. Plots of $\sqrt{\text{Var}[\hat{y}(\mathbf{x}_0)]}$, with σ^2 estimated by the residual mean square $MS_{\text{Res}} = 5.89$ for this model for all values of \mathbf{x}_0 in the region of experimentation, are presented in panels *a* and *b* of Figure 7.18. Both the response surface in Figure 7.18*a* and the contour plot of constant $\sqrt{\text{Var}[\hat{y}(\mathbf{x}_0)]}$ in Figure 7.18*b* show that the $\sqrt{\text{Var}[\hat{y}(\mathbf{x}_0)]}$ is the same for all points \mathbf{x}_0 that are the same distance from the center of the design. This is a result of the spacing of the axial runs in the central composite design at 1.414 units from the origin (in the coded variables) and is a design property called **rotatability**. This is a very important property for a second-order response surface design and is discussed in detail in the references given on RSM.

7.5 ORTHOGONAL POLYNOMIALS

We have noted that in fitting polynomial models in one variable, even if nonessential ill-conditioning is removed by centering, we may still have high levels of multicollinearity. Some of these difficulties can be eliminated by using **orthogonal polynomials** to fit the model.

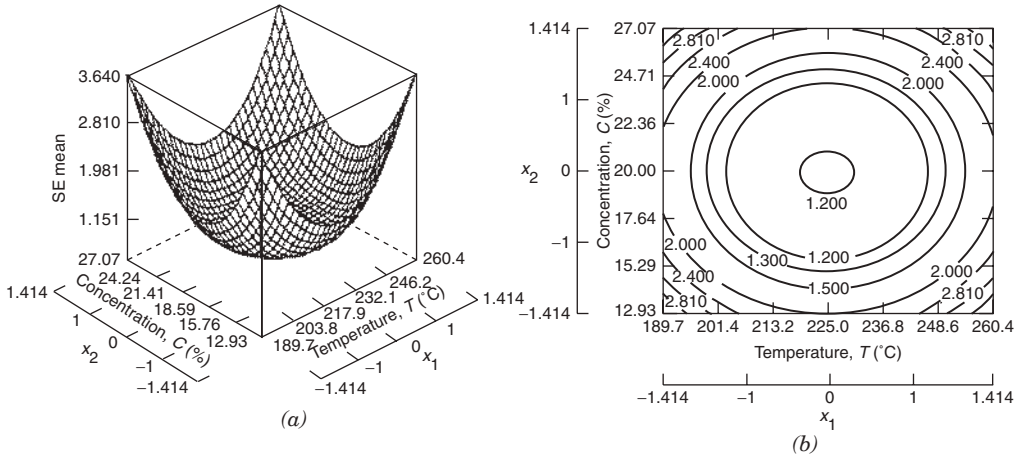

Figure 7.18 (a) Response surface plot of $\sqrt{\text{Var}[\hat{y}(\mathbf{x}_0)]}$. (b) Contour plot of $\sqrt{\text{Var}[\hat{y}(\mathbf{x}_0)]}$.

Suppose that the model is

$$y_i = \beta_0 + \beta_1 x_i + \beta_2 x_i^2 + \dots + \beta_k x_i^k + \varepsilon_i, \quad i = 1, 2, \dots, n \tag{7.8}$$

Generally the columns of the \mathbf{X} matrix will not be orthogonal. Furthermore, if we increase the order of the polynomial by adding a term $\beta_{k+1} x^{k+1}$, we must recompute $(\mathbf{X}'\mathbf{X})^{-1}$ and the estimates of the lower order parameters $\hat{\beta}_0, \hat{\beta}_1, \dots, \hat{\beta}_k$ will change.

Now suppose that we fit the model

$$y_i = \alpha_0 P_0(x_i) + \alpha_1 P_1(x_i) + \alpha_2 P_2(x_i) + \dots + \alpha_k P_k(x_i) + \varepsilon_i, \quad i = 1, 2, \dots, n \tag{7.9}$$

where $P_u(x_i)$ is a u th-order orthogonal polynomial defined such that

$$\sum_{i=1}^n P_r(x_i) P_s(x_i) = 0, \quad r \neq s, \quad r, s = 0, 1, 2, \dots, k$$

$$P_0(x_i) = 1$$

Then the model becomes $\mathbf{y} = \mathbf{X}\boldsymbol{\alpha} + \boldsymbol{\varepsilon}$, where the \mathbf{X} matrix is

$$\mathbf{X} = \begin{bmatrix} P_0(x_1) & P_1(x_1) & \dots & P_k(x_1) \\ P_0(x_2) & P_1(x_2) & \dots & P_k(x_2) \\ \vdots & \vdots & & \vdots \\ P_0(x_n) & P_1(x_n) & \dots & P_k(x_n) \end{bmatrix}$$

Since this matrix has orthogonal columns, the $\mathbf{X}'\mathbf{X}$ matrix is

$$\mathbf{X}'\mathbf{X} = \begin{bmatrix} \sum_{i=1}^n P_0^2(x_i) & 0 & \cdots & 0 \\ 0 & \sum_{i=1}^n P_1^2(x_i) & \cdots & 0 \\ \vdots & \vdots & \ddots & \vdots \\ 0 & 0 & \cdots & \sum_{i=1}^n P_k^2(x_i) \end{bmatrix}$$

The least-squares estimators of α are found from $(\mathbf{X}'\mathbf{X})^{-1}\mathbf{X}'\mathbf{y}$ as

$$\hat{\alpha}_j = \frac{\sum_{i=1}^n P_j(x_i) y_i}{\sum_{i=1}^n P_j^2(x_i)}, \quad j = 0, 1, \dots, k \quad (7.10)$$

Since $P_0(x_i)$ is a polynomial of degree zero, we can set $P_0(x_i) = 1$, and consequently

$$\hat{\alpha}_0 = \hat{y}$$

The residual sum of squares is

$$SS_{\text{Res}}(k) = SS_{\text{T}} - \sum_{j=1}^k \hat{\alpha}_j \left[\sum_{i=1}^n P_j(x_i) y_i \right] \quad (7.11)$$

The regression sum of squares for any model parameter does not depend on the other parameters in the model. This regression sum of squares is

$$SS_{\text{R}}(\alpha_j) = \hat{\alpha}_j \sum_{i=1}^n P_j(x_i) y_i \quad (7.12)$$

If we wish to assess the significance of the highest order term, we should test $H_0: \alpha_k = 0$ [this is equivalent to testing $H_0: \beta_k = 0$ in Eq. (7.4)]; we would use

$$F_0 = \frac{SS_{\text{R}}(\alpha_k)}{SS_{\text{Res}}(k)/(n-k-1)} = \frac{\hat{\alpha}_k \sum_{i=1}^n P_k(x_i) y_i}{SS_{\text{Res}}(k)/(n-k-1)} \quad (7.13)$$

as the F statistic. Furthermore, note that if the order of the model is changed to $k+r$, only the r new coefficients must be computed. The coefficients $\hat{\alpha}_0, \hat{\alpha}_1, \dots, \hat{\alpha}_k$

do not change due to the orthogonality property of the polynomials. Thus, sequential fitting of the model is computationally easy.

The orthogonal polynomials $P_j(x_i)$ are easily constructed for the case where the levels of x are equally spaced. The first five orthogonal polynomials are

$$\begin{aligned}
 P_0(x_i) &= 1 \\
 P_1(x_i) &= \lambda_1 \left[\frac{x_i - \bar{x}}{d} \right] \\
 P_2(x_i) &= \lambda_2 \left[\left(\frac{x_i - \bar{x}}{d} \right)^2 - \left(\frac{n^2 - 1}{12} \right) \right] \\
 P_3(x_i) &= \lambda_3 \left[\left(\frac{x_i - \bar{x}}{d} \right)^3 - \left(\frac{x_i - \bar{x}}{d} \right) \left(\frac{3n^2 - 7}{20} \right) \right] \\
 P_4(x_i) &= \lambda_4 \left[\left(\frac{x_i - \bar{x}}{d} \right)^4 - \left(\frac{x_i - \bar{x}}{d} \right)^2 \left(\frac{3n^2 - 13}{14} \right) + \frac{3(n^2 - 1)(n^2 - 9)}{560} \right]
 \end{aligned}$$

where d is the spacing between the levels of x and the $\{\lambda_j\}$ are constants chosen so that the polynomials will have integer values. A brief table of the numerical values of these orthogonal polynomials is given in Table A.5. More extensive tables are found in DeLury [1960] and Pearson and Hartley [1966]. Orthogonal polynomials can also be constructed and used in cases where the x 's are not equally spaced. A survey of methods for generating orthogonal polynomials is in Seber [1977, Ch. 8].

Example 7.5 Orthogonal Polynomials

An operations research analyst has developed a computer simulation model of a single item inventory system. He has experimented with the simulation model to investigate the effect of various reorder quantities on the average annual cost of the inventory. The data are shown in Table 7.11.

TABLE 7.11 Inventory Simnlation Ontpnt far Example 7.5

Reorder Quantity, x_i	Average Annual Cost, y_i
50	\$335
75	326
100	316
125	313
150	311
175	314
200	318
225	328
250	337
275	345

TABLE 7.12 Coefficients of Orthogonal Polynomials for Example 7.5

i	$P_0(x_i)$	$P_1(x_i)$	$P_2(x_i)$
1	1	-9	6
2	1	-7	2
3	1	-5	-1
4	1	-3	-3
5	1	-1	-4
6	1	1	-4
7	1	3	-3
8	1	5	-1
9	1	7	2
10	1	9	6
	$\sum_{i=1}^{10} P_0^2(x_i) = 10$	$\sum_{i=1}^{10} P_1^2(x_i) = 330$ $\lambda_1 = 2$	$\sum_{i=1}^{10} P_2^2(x_i) = 132$ $\lambda_2 = \frac{1}{2}$

Since we know that average annual inventory cost is a convex function of the reorder quantity, we suspect that a second-order polynomial is the highest order model that must be considered. Therefore, we will fit

$$y_i = \alpha_0 P_0(x_i) + \alpha_1 P_1(x_i) + \alpha_2 P_2(x_i) + \varepsilon_i, \quad i = 1, 2, \dots, 10$$

The coefficients of the orthogonal polynomials $P_0(x_i)$, $P_1(x_i)$, and $P_2(x_i)$, obtained from Table A.5, are shown in Table 7.12.

Thus,

$$\mathbf{X}'\mathbf{X} = \begin{bmatrix} \sum_{i=1}^{10} P_0^2(x_i) & 0 & 0 \\ 0 & \sum_{i=1}^{10} P_1^2(x_i) & 0 \\ 0 & 0 & \sum_{i=1}^{10} P_2^2(x_i) \end{bmatrix} = \begin{bmatrix} 10 & 0 & 0 \\ 0 & 330 & 0 \\ 0 & 0 & 132 \end{bmatrix}$$

$$\mathbf{X}'\mathbf{y} = \begin{bmatrix} \sum_{i=1}^{10} P_0(x_i) y_i \\ \sum_{i=1}^{10} P_1(x_i) y_i \\ \sum_{i=1}^{10} P_2(x_i) y_i \end{bmatrix} = \begin{bmatrix} 3243 \\ 245 \\ 369 \end{bmatrix}$$

TABLE 7.13 Analysis of Variance for the Quadratic Model in Example 7.5

Source of Variation	Sum of Squares	Degrees of Freedom	Mean Square	F_0	P Value
Regression	1213.43	2	606.72	159.24	<0.0001
Linear, α_1	(181.89)	1	181.89	47.74	<0.0002
Quadratic, α_2	(1031.54)	1	1031.54	270.75	<0.0001
Residual	26.67	7	3.81		
Total	1240.10	9			

and

$$\hat{\boldsymbol{\beta}} = (\mathbf{X}'\mathbf{X})^{-1}\mathbf{X}'\mathbf{y} = \begin{bmatrix} \frac{1}{10} & 0 & 0 \\ 0 & \frac{1}{330} & 0 \\ 0 & 0 & \frac{1}{132} \end{bmatrix} = \begin{bmatrix} 3243 \\ 245 \\ 369 \end{bmatrix} = \begin{bmatrix} 324.3000 \\ 0.7424 \\ 2.7955 \end{bmatrix}$$

The fitted model is

$$\hat{y} = 324.30 + 0.7424P_1(x) + 2.7955P_2(x)$$

The regression sum of squares is

$$\begin{aligned} SS_R(\alpha_1, \alpha_2) &= \sum_{j=1}^2 \hat{\alpha}_j \left[\sum_{i=1}^{10} P_j(x_i) y_i \right] \\ &= 0.7424(245) + 2.7955(369) \\ &= 181.89 + 1031.54 = 1213.43 \end{aligned}$$

The analysis of variance is shown in Table 7.13. Both the linear and quadratic terms contribute significantly to the model. Since these terms account for most of the variation in the data, we tentatively adopt the quadratic model subject to a satisfactory residual analysis.

We may obtain a fitted equation in terms of the original regressor by substituting for $P_j(x_i)$ as follows:

$$\begin{aligned} \hat{y} &= 324.30 + 0.7424P_1(x) + 2.7955P_2(x) \\ &= 324.30 + 0.7424(2)\left(\frac{x-162.5}{25}\right) + 2.7955\frac{1}{2}\left[\left(\frac{x-162.5}{25}\right)^2 - \frac{(10)^2-1}{12}\right] \\ &= 312.7686 + 0.0594(x-162.5) + 0.0022(x-162.5)^2 \end{aligned}$$

This form of the model should be reported to the user. ■

PROBLEMS

7.1 Consider the values of x shown below:

$$x = 1.00, 1.70, 1.25, 1.20, 1.45, 1.85, 1.60, 1.50, 1.95, 2.00$$

Suppose that we wish to fit a second-order model using these levels for the regressor variable x . Calculate the correlation between x and x^2 . Do you see any potential difficulties in fitting the model?

7.2 A solid-fuel rocket propellant loses weight after it is produced. The following data are available:

Months since Production, x	Weight Loss, y (kg)
0.25	1.42
0.50	1.39
0.75	1.55
1.00	1.89
1.25	2.43
1.50	3.15
1.75	4.05
2.00	5.15
2.25	6.43
2.50	7.89

- Fit a second-order polynomial that expresses weight loss as a function of the number of months since production.
- Test for significance of regression.
- Test the hypothesis $H_0: \beta_2 = 0$. Comment on the need for the quadratic term in this model.
- Are there any potential hazards in extrapolating with this model?

7.3 Refer to Problem 7.2. Compute the residuals for the second-order model. Analyze the residuals and comment on the adequacy of the model.

7.4 Consider the data shown below:

x	y	x	y
4.00	24.60	6.50	67.11
4.00	24.71	6.50	67.24
4.00	23.90	6.75	67.15
5.00	39.50	7.00	77.87
5.00	39.60	7.10	80.11
6.00	57.12	7.30	84.67

- Fit a second-order polynomial model to these data.
- Test for significance of regression.

- c. Test for lack of fit and comment on the adequacy of the second-order model.
- d. Test the hypothesis $H_0: \beta_2 = 0$. Can the quadratic term be deleted from this equation?

7.5 Refer to Problem 7.4. Compute the residuals from the second-order model. Analyze the residuals and draw conclusions about the adequacy of the model.

7.6 The carbonation level of a soft drink beverage is affected by the temperature of the product and the filler operating pressure. Twelve observations were obtained and the resulting data are shown below.

Carbonation, y	Temperature, x_1	Pressure, x_2
2.60	31.0	21.0
2.40	31.0	21.0
17.32	31.5	24.0
15.60	31.5	24.0
16.12	31.5	24.0
5.36	30.5	22.0
6.19	31.5	22.0
10.17	30.5	23.0
2.62	31.0	21.5
2.98	30.5	21.5
6.92	31.0	22.5
7.06	30.5	22.5

- a. Fit a second-order polynomial.
- b. Test for significance of regression.
- c. Test for lack of fit and draw conclusions.
- d. Does the interaction term contribute significantly to the model?
- e. Do the second-order terms contribute significantly to the model?

7.7 Refer to Problem 7.6. Compute the residuals from the second-order model. Analyze the residuals and comment on the adequacy of the model.

7.8 Consider the data in Problem 7.2.

- a. Fit a second-order model to these data using orthogonal polynomials.
- b. Suppose that we wish to investigate the addition of a third-order term to this model. Comment on the necessity of this additional term. Support your conclusions with an appropriate statistical analysis.

7.9 Suppose we wish to fit the piecewise quadratic polynomial with a knot at $x = t$:

$$E(y) = S(x) = \beta_{00} + \beta_{01}x + \beta_{02}x^2 + \beta_{10}(x-t)_+^0 + \beta_{11}(x-t)_+^1 + \beta_{12}(x-t)_+^2$$

- a. Show how to test the hypothesis that this quadratic spline model fits the data significantly better than an ordinary quadratic polynomial.

- b.** The quadratic spline polynomial model is not continuous at the knot t . How can the model be modified so that continuity at $x = t$ is obtained?
- c.** Show how the model can be modified so that both $E(y)$ and $dE(y)/dx$ are continuous at $x = t$.
- d.** Discuss the significance of the continuity restrictions on the model in parts b and c. In practice, how would you select the type of continuity restrictions to impose?

7.10 Consider the delivery time data in Example 3.1. Is there any indication that a complete second-order model in the two regressions cases and distance is preferable to the first-order model in Example 3.1?

7.11 Consider the patient satisfaction data in Section 3.6. Fit a complete second-order model to those data. Is there any indication that adding these terms to the model is necessary?

7.12 Suppose that we wish to fit a piecewise polynomial model with three segments: if $x < t_1$, the polynomial is linear; if $t_1 \leq x < t_2$, the polynomial is quadratic; and if $x > t_2$, the polynomial is linear. Consider the model

$$E(y) = S(x) = \beta_{00} + \beta_{01}x + \beta_{02}x^2 + \beta_{10}(x - t_1)_+^0 + \beta_{11}(x - t_1)_+^1 + \beta_{12}(x - t_1)_+^2 + \beta_{20}(x - t_2)_+^2 + \beta_{21}(x - t_2)_+^1 + \beta_{22}(x - t_2)_+^2$$

- a.** Does this segmented polynomial satisfy our requirements? If not, show how it can be modified to do so.
- b.** Show how the segmented model would be modified to ensure that $E(y)$ is continuous at the knots t_1 and t_2 .
- c.** Show how the segmented model would be modified to ensure that both $E(y)$ and $dE(y)/dx$ are continuous at the knots t_1 and t_2 .
- 7.13** An operations research analyst is investigating the relationship between production lot size x and the average production cost per unit y . A study of recent operations provides the following data:

x	100	120	140	160	180	200	220	240	260	280	300
y	\$9.73	9.61	8.15	6.98	5.87	4.98	5.09	4.79	4.02	4.46	3.82

The analyst suspects that a piecewise linear regression model should be fit to these data. Estimate the parameters in such a model assuming that the slope of the line changes at $x = 200$ units. Do the data support the use of this model?

- 7.14** Modify the model in Problem 7.13 to investigate the possibility that a discontinuity exists in the regression function at $x = 200$ units. Estimate the parameters in this model. Test appropriate hypotheses to determine if the regression function has a change in both the slope and the intercept at $x = 200$ units.
- 7.15** Consider the polynomial model in Problem 7.13. Find the variance inflation factors and comment on multicollinearity in this model.

- 7.16** Consider the data in Problem 7.2.
- Fit a second-order model $y = \beta_0 + \beta_1x + \beta_{11}x^2 + \varepsilon$ to the data. Evaluate the variance inflation factors.
 - Fit a second-order model $y = \beta_0 + \beta_1(x - \bar{x}) + \beta_{11}(x - \bar{x})^2 + \varepsilon$ to the data. Evaluate the variance inflation factors.
 - What can you conclude about the impact of centering the x 's in a polynomial model on multicollinearity?
- 7.17** Chemical and mechanical engineers often need to know the vapor pressure of water at various temperatures (the “infamous” steam tables can be used for this). Below are data on the vapor pressure of water (y) at various temperatures.

Vapor Pressure, y (mmHg)	Temperature, x (°C)
9.2	10
17.5	20
31.8	30
55.3	40
92.5	50
149.4	60

- Fit a first-order model to the data. Overlay the fitted model on the scatterplot of y versus x . Comment on the apparent fit of the model.
 - Prepare a scatterplot of predicted y versus the observed y . What does this suggest about model fit?
 - Plot residuals versus the fitted or predicted y . Comment on model adequacy.
 - Fit a second-order model to the data. Is there evidence that the quadratic term is statistically significant?
 - Repeat parts a–c using the second-order model. Is there evidence that the second-order model provides a better fit to the vapor pressure data?
- 7.18** An article in the *Journal of Pharmaceutical Sciences* (80, 971–977, 1991) presents data on the observed mole fraction solubility of a solute at a constant temperature, along with $x_1 =$ dispersion partial solubility, $x_2 =$ dipolar partial solubility, and $x_3 =$ hydrogen bonding Hansen partial solubility. The response y is the negative logarithm of the mole fraction solubility.
- Fit a complete quadratic model to the data.
 - Test for significance of regression, and construct t statistics for each model parameter. Interpret these results.
 - Plot residuals and comment on model adequacy.
 - Use the extra-sum-of-squares method to test the contribution of all second-order terms to the model.

Observation Number	y	x_1	x_2	x_3
1	0.22200	7.3	0.0	0.0
2	0.39500	8.7	0.0	0.3
3	0.42200	8.8	0.7	1.0
4	0.43700	8.1	4.0	0.2
5	0.42800	9.0	0.5	1.0
6	0.46700	8.7	1.5	2.8
7	0.44400	9.3	2.1	1.0
8	0.37800	7.6	5.1	3.4
9	0.49400	10.0	0.0	0.3
10	0.45600	8.4	3.7	4.1
11	0.45200	9.3	3.6	2.0
12	0.11200	7.7	2.8	7.1
13	0.43200	9.8	4.2	2.0
14	0.10100	7.3	2.5	6.8
15	0.23200	8.5	2.0	6.6
16	0.30600	9.5	2.5	5.0
17	0.09230	7.4	2.8	7.8
18	0.11600	7.8	2.8	7.7
19	0.07640	7.7	3.0	8.0
20	0.43900	10.3	1.7	4.2
21	0.09440	7.8	3.3	8.5
22	0.11700	7.1	3.9	6.6
23	0.07260	7.7	4.3	9.5
24	0.04120	7.4	6.0	10.9
25	0.25100	7.3	2.0	5.2
26	0.00002	7.6	7.8	20.7

- 7.19** Consider the quadratic regression model from Problem 7.18. Find the variance inflation factors and comment on multicollinearity in this model.
- 7.20** Consider the solubility data from Problem 7.18. Suppose that a point of interest is $x_1 = 8.0$, $x_2 = 3.0$, and $x_3 = 5.0$.
- For the quadratic model from Problem 7.18, predict the response at the point of interest and find a 95% confidence interval on the mean response at that point.
 - Fit a model that includes only the main effects and two-factor interactions to the solubility data. Use this model to predict the response at the point of interest. Find a 95% confidence interval on the mean response at that point.
 - Compare the lengths of the confidence intervals in parts a and b. Can you draw any conclusions about the best model from this comparison?
- 7.21** Below are data on $y =$ green liquor (g/l) and $x =$ paper machine speed (ft/min) from a kraft paper machine. (The data were read from a graph in an article in the *Tappi Journal*, March 1986.)

y	16.0	15.8	15.6	15.5	14.8
x	1700	1720	1730	1740	1750
y	14.0	13.5	13.0	12.0	11.0
x	1760	1770	1780	1790	1795

- a. Fit the model $y = \beta_0 + \beta_1x + \beta_2x^2 + \varepsilon$ to the data.
 - b. Test for significance of regression using $\alpha = 0.05$. What are your conclusions?
 - c. Test the contribution of the quadratic term to the model, the contribution of the linear term, using an F statistic. If $\alpha = 0.05$, what conclusion can you draw?
 - d. Plot the residuals from the model. Does the model fit seem satisfactory?
- 7.22** Reconsider the data from Problem 7.21. Suppose that it is important to predict the response at the points $x = 1750$ and $x = 1775$.
- a. Find the predicted response at these points and the 95% prediction intervals for the future observed response at these points.
 - b. Suppose that a first-order model is also being considered. Fit this model and find the predicted response at these points. Calculate the 95% prediction intervals for the future observed response at these points. Does this give any insight about which model should be preferred?

CHAPTER 8

INDICATOR VARIABLES

8.1 GENERAL CONCEPT OF INDICATOR VARIABLES

The variables employed in regression analysis are often **quantitative variables**, that is, the variables have a well-defined scale of measurement. Variables such as temperature, distance, pressure, and income are quantitative variables. In some situations it is necessary to use **qualitative** or **categorical variables** as predictor variables in regression. Examples of qualitative or categorical variables are operators, employment status (employed or unemployed), shifts (day, evening, or night), and sex (male or female). In general, a qualitative variable has no natural scale of measurement. We must assign a set of levels to a qualitative variable to account for the effect that the variable may have on the response. This is done through the use of **indicator variables**. Sometimes indicator variables are called **dummy variables**.

Suppose that a mechanical engineer wishes to relate the effective life of a cutting tool (y) used on a lathe to the lathe speed in revolutions per minute (x_1) and the type of cutting tool used. The second regressor variable, tool type, is qualitative and has two levels (e.g., tool types A and B). We use an indicator variable that takes on the values 0 and 1 to identify the classes of the regressor variable “tool type.” Let

$$x_2 = \begin{cases} 0 & \text{if the observation is from tool type A} \\ 1 & \text{if the observation is from tool type B} \end{cases}$$

The choice of 0 and 1 to identify the levels of a qualitative variable is arbitrary. Any two distinct values for x_2 would be satisfactory, although 0 and 1 are usually best.

Assuming that a first-order model is appropriate, we have

$$y = \beta_0 + \beta_1 x_1 + \beta_2 x_2 + \varepsilon \tag{8.1}$$

To interpret the parameters in this model, consider first tool type A, for which $x_2 = 0$. The regression model becomes

$$\begin{aligned} y &= \beta_0 + \beta_1 x_1 + \beta_2(0) + \varepsilon \\ &= \beta_0 + \beta_1 x_1 + \varepsilon \end{aligned} \tag{8.2}$$

Thus, the relationship between tool life and lathe speed for tool type A is a straight line with intercept β_0 and slope β_1 . For tool type B, we have $x_2 = 1$, and

$$\begin{aligned} y &= \beta_0 + \beta_1 x_1 + \beta_2(1) + \varepsilon \\ &= (\beta_0 + \beta_2) + \beta_1 x_1 + \varepsilon \end{aligned} \tag{8.3}$$

That is, for tool type B the relationship between tool life and lathe speed is also a straight line with slope β_1 but intercept $\beta_0 + \beta_2$.

The two response functions are shown in Figure 8.1. The models (8.2) and (8.3) describe two **parallel** regression lines, that is, two lines with a common slope β_1 and different intercepts. Also the variance of the errors ε is assumed to be the same for both tool types A and B. The parameter β_2 expresses the difference in heights between the two regression lines, that is, β_2 is a measure of the difference in mean tool life resulting from changing from tool type A to tool type B.

We may generalize this approach to qualitative factors with any number of levels. For example, suppose that three tool types, A, B, and C, are of interest. Two indicator

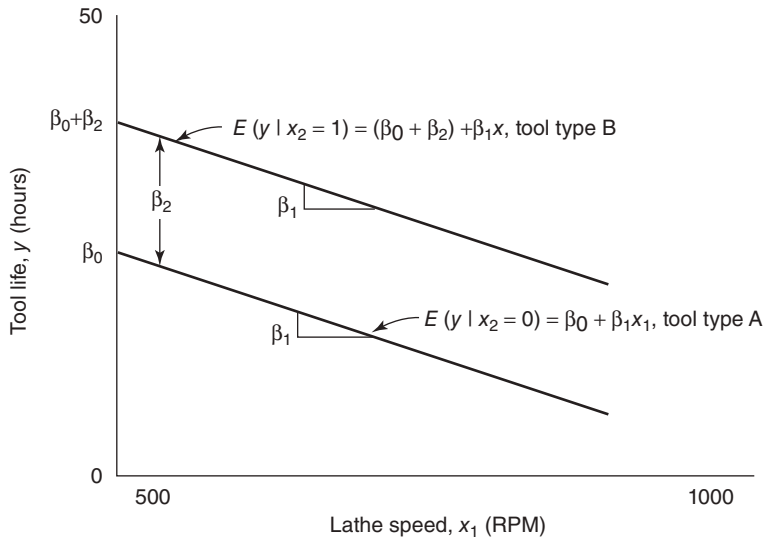

Figure 8.1 Response functions for the tool life example.

variables, such as x_2 and x_3 , will be required to incorporate the three levels of tool type into the model. The levels of the indicator variables are

x_2	x_3	
0	0	if the observation is from tool type A
1	0	if the observation is from tool type B
0	1	if the observation is from tool type C

and the regression model is

$$y = \beta_0 + \beta_1x_1 + \beta_2x_2 + \beta_3x_3 + \varepsilon$$

In general, a qualitative variable with a levels is represented by $a - 1$ indicator variables, each taking on the values 0 and 1.

Example 8.1 The Tool Life Data

Twenty observations on tool life and lathe speed are presented in Table 8.1, and the scatter diagram is shown in Figure 8.2. Inspection of this scatter diagram indicates that two different regression lines are required to adequately model these data, with the intercept depending on the type of tool used. Therefore, we fit the model

$$y = \beta_0 + \beta_1x_1 + \beta_2x_2 + \varepsilon$$

TABLE 8.1 Data, Fitted Values, and Residuals for Example 8.1

i	y_i (hours)	X_{i1} (rpm)	Tool Type	\hat{y}_i	e_i
1	18.73	610	A	20.7552	-2.0252
2	14.52	950	A	11.7087	2.8113
3	17.43	720	A	17.8284	-0.3984
4	14.54	840	A	14.6355	-0.0955
5	13.44	980	A	10.9105	2.5295
6	24.39	530	A	22.8838	1.5062
7	13.34	680	A	18.8927	-5.5527
8	22.71	540	A	22.6177	0.0923
9	12.68	890	A	13.3052	-0.6252
10	19.32	730	A	17.5623	1.7577
11	30.16	670	B	34.1630	-4.0030
12	27.09	770	B	31.5023	-4.4123
13	25.40	880	B	28.5755	-3.1755
14	26.05	1000	B	25.3826	0.6674
15	33.49	760	B	31.7684	1.7216
16	35.62	590	B	36.2916	-0.6716
17	26.07	910	B	27.7773	-1.7073
18	36.78	650	B	34.6952	2.0848
19	34.95	810	B	30.4380	4.5120
20	43.67	500	B	38.6862	4.9838

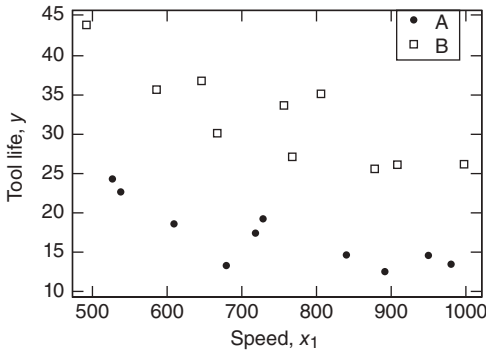

Figure 8.2 Plot of tool life y versus lathe speed x_1 for tool types A and B.

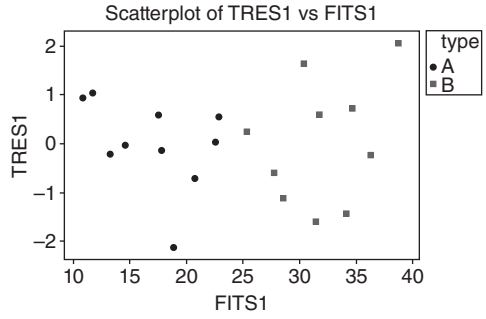

Figure 8.3 Plot of externally studentized residuals t versus fitted values \hat{y}_i , Example 8.1.

where the indicator variable $x_2 = 0$ if the observation is from tool type A and $x_2 = 1$ if the observation is from tool type B. The \mathbf{X} matrix and \mathbf{y} vector for fitting this model are

$$\mathbf{X} = \begin{bmatrix} 1 & 610 & 0 \\ 1 & 950 & 0 \\ 1 & 720 & 0 \\ 1 & 840 & 0 \\ 1 & 980 & 0 \\ 1 & 530 & 0 \\ 1 & 680 & 0 \\ 1 & 540 & 0 \\ 1 & 890 & 0 \\ 1 & 730 & 0 \\ 1 & 670 & 1 \\ 1 & 770 & 1 \\ 1 & 880 & 1 \\ 1 & 1000 & 1 \\ 1 & 760 & 1 \\ 1 & 590 & 1 \\ 1 & 910 & 1 \\ 1 & 650 & 1 \\ 1 & 810 & 1 \\ 1 & 500 & 1 \end{bmatrix} \quad \text{and} \quad \mathbf{y} = \begin{bmatrix} 18.73 \\ 14.52 \\ 17.43 \\ 14.54 \\ 13.44 \\ 24.39 \\ 13.34 \\ 22.71 \\ 12.68 \\ 19.32 \\ 30.16 \\ 27.09 \\ 25.40 \\ 26.05 \\ 33.49 \\ 35.62 \\ 26.07 \\ 36.78 \\ 34.95 \\ 43.67 \end{bmatrix}$$

TABLE 8.2 Summary Statistics for the Regression Model in Example 8.1

Source of Variation	Sum of Squares	Degrees of Freedom	Mean Square	F_0	P Value
Regression	1418.034	2	709.017	76.75	3.12×10^{-9}
Residual	157.055	17	9.239		
Total	1575.089	19			
Coefficient	Estimate	Standard Error	t_0	P Value	
β_0	36.986				
β_1	-0.027	0.005	-5.887	8.97×10^{-6}	
β_2	15.004	1.360	11.035	1.79×10^{-9}	
	$R^2 = 0.9003$				

The least-squares fit is

$$\hat{y} = 36.986 - 0.027x_1 + 15.004x_2$$

The analysis of variance and other summary statistics for this model are shown in Table 8.2. Since the observed value of F_0 has a very small P value, the hypothesis of significance of regression is rejected, and since the t statistics for β_1 and β_2 have small P values, we conclude that both regressors x_1 (rpm) and x_2 (tool type) contribute to the model. The parameter β_2 is the change in mean tool life resulting from a change from tool type A to tool type B. The 95 % confidence interval on β_2 is

$$\hat{\beta}_2 - t_{0.025,17} \text{se}(\hat{\beta}_2) \leq \beta_2 \leq \hat{\beta}_2 + t_{0.025,17} \text{se}(\hat{\beta}_2)$$

$$15.004 - 2.110(1.360) \leq \beta_2 \leq 15.004 + 2.110(1.360)$$

or

$$12.135 \leq \beta_2 \leq 17.873$$

Therefore, we are 95% confident that changing from tool type A to tool type B increases the mean tool life by between 12.135 and 17.873 hours.

The fitted values \hat{y}_i and the residuals e_i from this model are shown in the last two columns of Table 8.1. A plot of the residuals versus \hat{y}_i is shown in Figure 8.3. The residuals in this plot are identified by tool type (A or B). If the variance of the errors is not the same for both tool types, this should show up in the plot. Note that the “B” residuals in Figure 8.3 exhibit slightly more scatter than the “A” residuals, implying that there may be a mild inequality-of-variance problem. Figure 8.4 is the normal probability plot of the residuals. There is no indication of serious model inadequacies. ■

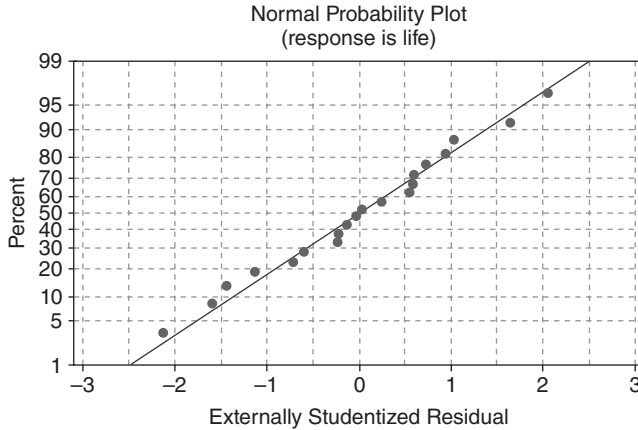

Figure 8.4 Normal probability plot of externally studentized residuals, Example 8.1.

Since two different regression lines are employed to model the relationship between tool life and lathe speed in Example 8.1, we could have initially fit two separate straight-line models instead of a single model with an indicator variable. However, the single-model approach is preferred because the analyst has only one final equation to work with instead of two, a much simpler practical result. Furthermore, since both straight lines are assumed to have the same slope, it makes sense to combine the data from both tool types to produce a single estimate of this common parameter. This approach also gives one estimate of the common error variance σ^2 and more residual degrees of freedom than would result from fitting two separate regression lines.

Now suppose that we expect the regression lines relating tool life to lathe speed to differ in both intercept and slope. It is possible to model this situation with a single regression equation by using indicator variables. The model is

$$y = \beta_0 + \beta_1 x_1 + \beta_2 x_2 + \beta_3 x_1 x_2 + \varepsilon \tag{8.4}$$

Comparing Eq. (8.4) with Eq. (8.1) we observe that a cross product between lathe speed x_1 and the indicator variable denoting tool type x_2 has been added to the model. To interpret the parameters in this model, first consider tool type A, for which $x_2 = 0$. Model (8.4) becomes

$$\begin{aligned} y &= \beta_0 + \beta_1 x_1 + \beta_2(0) + \beta_3 x_1(0) + \varepsilon \\ &= \beta_0 + \beta_1 x_1 + \varepsilon \end{aligned} \tag{8.5}$$

which is a straight line with intercept β_0 and slope β_1 . For tool type B, we have $x_2 = 1$, and

$$\begin{aligned} y &= \beta_0 + \beta_1 x_1 + \beta_2(1) + \beta_3 x_1(1) + \varepsilon \\ &= (\beta_0 + \beta_2) + (\beta_1 + \beta_3) x_1 + \varepsilon \end{aligned} \tag{8.6}$$

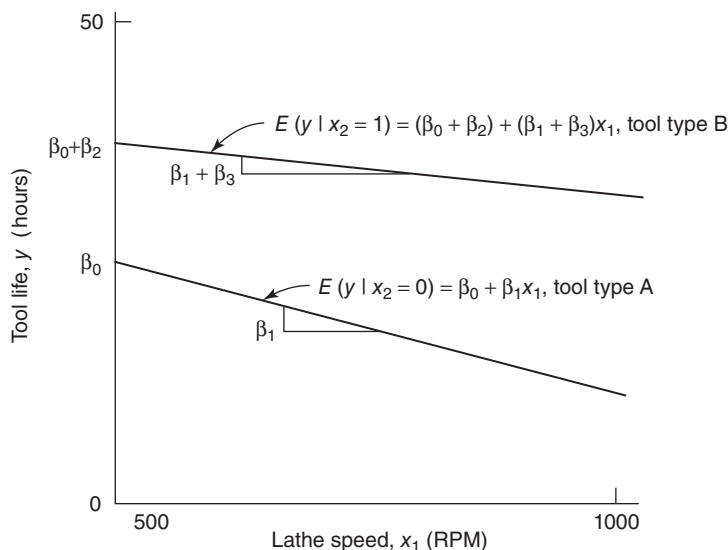

Figure 8.5 Response functions for Eq. (8.4).

This is a straight-line model with intercept $\beta_0 + \beta_2$ and slope $\beta_1 + \beta_3$. Both regression functions are plotted in Figure 8.5. Note that Eq. (8.4) defines two regression lines with different slopes and intercepts. Therefore, the parameter β_2 reflects the change in the intercept associated with changing from tool type A to tool type B (the classes 0 and 1 for the indicator variable x_2), and β_3 indicates the change in the slope associated with changing from tool type A to tool type B.

Fitting model (8.4) is equivalent to fitting two separate regression equations. An advantage to the use of indicator variables is that tests of hypotheses can be performed directly using the extra-sum-of-squares method. For example, to test whether or not the two regression models are identical, we would test

$$H_0: \beta_2 = \beta_3 = 0$$

$$H_1: \beta_2 \neq 0 \text{ and/or } \beta_3 \neq 0$$

If $H_0: \beta_2 = \beta_3 = 0$ is not rejected, this would imply that a single regression model can explain the relationship between tool life and lathe speed. To test that the two regression lines have a common slope but possibly different intercepts, the hypotheses are

$$H_0: \beta_3 = 0, \quad H_1: \beta_3 \neq 0$$

By using model (8.4), both regression lines can be fitted and these tests performed with one computer run, provided the program produces the sums of squares $SS_R(\beta_1|\beta_0)$, $SS_R(\beta_2|\beta_0, \beta_1)$, and $SS_R(\beta_3|\beta_0, \beta_1, \beta_2)$.

Indicator variables are useful in a variety of regression situations. We will now present three further typical applications of indicator variables.

Example 8.2 The Tool Life Data

We will fit the regression model

$$y = \beta_0 + \beta_1x_1 + \beta_2x_2 + \beta_3x_1x_2 + \varepsilon$$

to the tool life data in Table 8.1. The **X** matrix and **y** vector for this model are

$$\mathbf{X} = \begin{matrix} & x_1 & x_2 & x_1x_2 \\ \begin{bmatrix} 1 & 610 & 0 & 0 \\ 1 & 950 & 0 & 0 \\ 1 & 720 & 0 & 0 \\ 1 & 840 & 0 & 0 \\ 1 & 980 & 0 & 0 \\ 1 & 530 & 0 & 0 \\ 1 & 680 & 0 & 0 \\ 1 & 540 & 0 & 0 \\ 1 & 890 & 0 & 0 \\ 1 & 730 & 0 & 0 \\ 1 & 670 & 1 & 670 \\ 1 & 770 & 1 & 770 \\ 1 & 880 & 1 & 880 \\ 1 & 1000 & 1 & 1000 \\ 1 & 760 & 1 & 760 \\ 1 & 590 & 1 & 590 \\ 1 & 910 & 1 & 910 \\ 1 & 650 & 1 & 650 \\ 1 & 810 & 1 & 810 \\ 1 & 500 & 1 & 500 \end{bmatrix} & \text{and } \mathbf{y} = \begin{bmatrix} 18.73 \\ 14.52 \\ 17.43 \\ 14.54 \\ 13.44 \\ 24.39 \\ 13.34 \\ 22.71 \\ 12.68 \\ 19.32 \\ 30.16 \\ 27.09 \\ 25.40 \\ 26.05 \\ 33.49 \\ 35.62 \\ 26.07 \\ 36.78 \\ 34.95 \\ 43.67 \end{bmatrix} \end{matrix}$$

The fitted regression model is

$$\hat{y} = 32.775 - 0.021x_1 + 23.971x_2 - 0.012x_1x_2$$

The summary analysis for this model is presented in Table 8.3. To test the hypothesis that the two regression lines are identical ($H_0: \beta_2 = \beta_3 = 0$), use the statistic

$$F_0 = \frac{SS_R(\beta_2, \beta_3 | \beta_1, \beta_0) / 2}{MS_{Res}}$$

Since

$$\begin{aligned} SS_R(\beta_2, \beta_3 | \beta_1, \beta_0) &= SS_R(\beta_1, \beta_2, \beta_3 | \beta_0) - SS_R(\beta_1 | \beta_0) \\ &= 1434.112 - 293.005 \\ &= 1141.107 \end{aligned}$$

the test statistic is

$$F_0 = \frac{SS_R(\beta_2, \beta_3 | \beta_1, \beta_0)/2}{MS_{Res}} = \frac{1141.107/2}{8.811} = 64.75$$

and since for this statistic $P = 2.14 \times 10^{-8}$, we conclude that the two regression lines are not identical. To test the hypothesis that the two lines have different intercepts and a common slope ($H_0: \beta_3 = 0$), use the statistic

$$F_0 = \frac{SS_R(\beta_3 | \beta_2, \beta_1, \beta_0)/1}{MS_{Res}} = \frac{16.078}{8.811} = 1.82$$

and since for this statistic $P = 0.20$, we conclude that the slopes of the two straight lines are the same. This can also be determined by using the t statistics for β_2 and β_3 in Table 8.3. ■

TABLE 8.3 Summary Analysis for the Tool Life Regression Model in Example 8.2

Source of Variation	Sum of Squares	Degrees of Freedom	Mean Square	F_0	P Value
Regression	1434.112	3	478.037	54.25	1.32×10^{-9}
Error	140.976	16	8.811		
Total	1575.008	19			

Coefficient	Estimate	Standard Error	t_0	Sum of Squares
β_0	32.775			
β_1	-0.021	0.0061	-3.45	$SS_R(\beta_1 \beta_0) = 293.005$
β_2	23.971	6.7690	3.45	$SS_R(\beta_2 \beta_1, \beta_0) = 1125.029$
β_3	-0.012	0.0088	-1.35	$SS_R(\beta_3 \beta_2, \beta_1, \beta_0) = 16.078$

$R^2 = 0.9105$

Example 8.3 An Indicator Variable with More Than Two Levels

An electric utility is investigating the effect of the size of a single-family house and the type of air conditioning used in the house on the total electricity consumption during warm-weather months. Let y be the total electricity consumption (in kilowatt-hours) during the period June through September and x_1 be the size of the

house (square feet of floor space). There are four types of air conditioning systems: (1) no air conditioning, (2) window units, (3) heat pump, and (4) central air conditioning. The four levels of this factor can be modeled by three indicator variables, x_2 , x_3 , and x_4 , defined as follows:

Type of Air Conditioning	x_2	x_3	x_4
No air conditioning	0	0	0
Window units	1	0	0
Heat pump	0	1	0
Central air conditioning	0	0	1

The regression model is

$$y = \beta_0 + \beta_1 x_1 + \beta_2 x_2 + \beta_3 x_3 + \beta_4 x_4 + \varepsilon \quad (8.7)$$

If the house has no air conditioning, Eq. (8.7) becomes

$$y = \beta_0 + \beta_1 x_1 + \varepsilon$$

If the house has window units, then

$$y = (\beta_0 + \beta_2) + \beta_1 x_1 + \varepsilon$$

If the house has a heat pump, the regression model is

$$y = (\beta_0 + \beta_3) + \beta_1 x_1 + \varepsilon$$

while if the house has central air conditioning, then

$$y = (\beta_0 + \beta_4) + \beta_1 x_1 + \varepsilon$$

Thus, model (8.7) assumes that the relationship between warm-weather electricity consumption and the size of the house is linear and that the slope does not depend on the type of air conditioning system employed. The parameters β_2 , β_3 , and β_4 modify the height (or intercept) of the regression model for the different types of air conditioning systems. That is, β_2 , β_3 , and β_4 measure the effect of window units, a heat pump, and a central air conditioning system, respectively, compared to no air conditioning. Furthermore, other effects can be determined by directly comparing the appropriate regression coefficients. For example, $\beta_3 - \beta_4$ reflects the relative efficiency of a heat pump compared to central air conditioning. Note also the

assumption that the variance of energy consumption does not depend on the type of air conditioning system used. This assumption may be inappropriate.

In this problem it would seem unrealistic to assume that the slope of the regression function relating mean electricity consumption to the size of the house does not depend on the type of air conditioning system. For example, we would expect the mean electricity consumption to increase with the size of the house, but the rate of increase should be different for a central air conditioning system than for window units because central air conditioning should be more efficient than window units for larger houses. That is, there should be an **interaction** between the size of the house and the type of air conditioning system. This can be incorporated into the model by expanding model (8.7) to include interaction terms. The resulting model is

$$y = \beta_0 + \beta_1 x_1 + \beta_2 x_2 + \beta_3 x_3 + \beta_4 x_4 + \beta_5 x_1 x_2 + \beta_6 x_1 x_3 + \beta_7 x_1 x_4 + \varepsilon \quad (8.8)$$

The four regression models corresponding to the four types of air conditioning systems are as follows:

$$\begin{aligned} y &= \beta_0 + \beta_1 x_1 + \varepsilon_1 && \text{(no air conditioning)} \\ y &= (\beta_0 + \beta_2) + (\beta_1 + \beta_5) x_1 + \varepsilon && \text{(window units)} \\ y &= (\beta_0 + \beta_3) + (\beta_1 + \beta_6) x_1 + \varepsilon && \text{(heat pump)} \\ y &= (\beta_0 + \beta_4) + (\beta_1 + \beta_7) x_1 + \varepsilon && \text{(central air conditioning)} \end{aligned}$$

Note that model (8.8) implies that each type of air conditioning system can have a separate regression line with a unique slope and intercept. ■

Example 8.4 More Than One Indicator Variable

Frequently there are several different qualitative variables that must be incorporated into the model. To illustrate, suppose that in Example 8.1 a second qualitative factor, the type of cutting oil used, must be considered. Assuming that this factor has two levels, we may define a second indicator variable, x_3 , as follows:

$$x_3 = \begin{cases} 0 & \text{if low-viscosity oil used} \\ 1 & \text{if medium-viscosity oil used} \end{cases}$$

A regression model relating tool life (y) to cutting speed (x_1), tool type (x_2), and type of cutting oil (x_3) is

$$y = \beta_0 + \beta_1 x_1 + \beta_2 x_2 + \beta_3 x_3 + \varepsilon \quad (8.9)$$

Clearly the slope β_1 of the regression model relating tool life to cutting speed does not depend on either the type of tool or the type of cutting oil. The intercept of the regression line depends on these factors in an additive fashion.

Various types of interaction effects may be added to the model. For example, suppose that we consider interactions between cutting speed and the two qualitative factors, so that model (8.9) becomes

$$y = \beta_0 + \beta_1x_1 + \beta_2x_2 + \beta_3x_3 + \beta_4x_1x_2 + \beta_5x_1x_3 + \epsilon \tag{8.10}$$

This implies the following situation:

Tool Type	Cutting Oil	Regression Model
A	Low viscosity	$y = \beta_0 + \beta_1x_1 + \epsilon$
B	Low viscosity	$y = (\beta_0 + \beta_2) + (\beta_1 + \beta_4)x_1 + \epsilon$
A	Medium viscosity	$y = (\beta_0 + \beta_3) + (\beta_1 + \beta_5)x_1 + \epsilon$
B	Medium viscosity	$y = (\beta_0 + \beta_2 + \beta_3) + (\beta_1 + \beta_4 + \beta_5)x_1 + \epsilon$

Notice that each combination of tool type and cutting oil results in a separate regression line, with different slopes and intercepts. However, the model is still additive with respect to the levels of the indicator variables. That is, changing from low- to medium-viscosity cutting oil changes the intercept by β_3 and the slope by β_5 regardless of the type of tool used.

Suppose that we add a cross-product term involving the two indicator variables x_2 and x_3 to the model, resulting in

$$y = \beta_0 + \beta_1x_1 + \beta_2x_2 + \beta_3x_3 + \beta_4x_1x_2 + \beta_5x_1x_3 + \beta_6x_2x_3 + \epsilon \tag{8.11}$$

We then have the following:

Tool Type	Cutting Oil	Regression Model
A	Low viscosity	$y = \beta_0 + \beta_1x_1 + \epsilon$
B	Low viscosity	$y = (\beta_0 + \beta_2) + (\beta_1 + \beta_4)x_1 + \epsilon$
A	Medium viscosity	$y = (\beta_0 + \beta_3) + (\beta_1 + \beta_5)x_1 + \epsilon$
B	Medium viscosity	$y = (\beta_0 + \beta_2 + \beta_3 + \beta_6) + (\beta_1 + \beta_4 + \beta_5)x_1 + \epsilon$

The addition of the cross-product term $\beta_6x_2x_3$ in Eq. (8.11) results in the effect of one indicator variable on the intercept depending on the level of the other indicator variable. That is, changing from low- to medium-viscosity cutting oil changes the intercept by β_3 if tool type A is used, but the same change in cutting oil changes the intercept by $\beta_3 + \beta_6$ if tool type B is used. If an interaction term $\beta_7x_1x_2x_3$ were added to model (8.11), then changing from low- to medium-viscosity cutting oil would have an effect on **both** the intercept **and** the slope, which depends on the type of tool used.

Unless prior information is available concerning the anticipated effect of tool type and cutting oil viscosity on tool life, we will have to let the data guide us in selecting the correct form of the model. This may generally be done by testing hypotheses about individual regression coefficients using the partial *F* test. For example, testing $H_0: \beta_6 = 0$ for model (8.11) would allow us to discriminate between the two candidate models (8.11) and (8.10). ■

Example 8.5 Comparing Regression Models

Consider the case of simple linear regression where the n observations can be formed into M groups, with the m th group having n_m observations. The most general model consists of M separate equations, such as

$$y = \beta_{0m} + \beta_{1m}x + \varepsilon, \quad m = 1, 2, \dots, M \quad (8.12)$$

It is often of interest to compare this general model to a more restrictive one. Indicator variables are helpful in this regard. We consider the following cases:

a. Parallel Lines In this situation all M slopes are identical, $\beta_{11} = \beta_{12} = \dots = \beta_{1M}$, but the intercepts may differ. Note that this is the type of problem encountered in Example 8.1 (where $M = 2$), leading to the use of an additive indicator variable. More generally we may use the extra-sum-of-squares method to test the hypothesis $H_0: \beta_{11} = \beta_{12} = \dots = \beta_{1M}$. Recall that this procedure involves fitting a **full model** (FM) and a **reduced model** (RM) restricted to the null hypothesis and computing the F statistic:

$$F_0 = \frac{[SS_{\text{Res}}(RM) - SS_{\text{Res}}(FM)] / (df_{RM} - df_{FM})}{SS_{\text{Res}}(FM) / df_{FM}} \quad (8.13)$$

If the reduced model is as satisfactory as the full model, then F_0 will be small compared to $F_{\alpha, df_{RM} - df_{FM}, df_{FM}}$. Large values of F_0 imply that the reduced model is inadequate.

To fit the full model (8.12), simply fit M separate regression equations. Then $SS_{\text{Res}}(FM)$ is found by adding the residual sums of squares from each separate regression. The degrees of freedom for $SS_{\text{Res}}(FM)$ is $df_{FM} = \sum_{m=1}^M (n_m - 2) = n - 2M$. To fit the reduced model, define $M - 1$ indicator variables D_1, D_2, \dots, D_{M-1} corresponding to the M groups and fit

$$y = \beta_0 + \beta_1x + \beta_2D_1 + \beta_3D_2 + \dots + \beta_M D_{M-1} + \varepsilon$$

The residual sum of squares from this model is $SS_{\text{Res}}(RM)$ with $df_{RM} = n - (M + 1)$ degrees of freedom.

If the F test (8.13) indicates that the M regression models have a common slope, then $\hat{\beta}_1$ from the reduced model is an estimate of this parameter found by pooling or combining all of the data. This was illustrated in Example 8.1. More generally, **analysis of covariance** is used to pool the data to estimate the common slope. The analysis of covariance is a special type of linear model that is a combination of a regression model (with quantitative factors) and an analysis-of-variance model (with qualitative factors). For an introduction to analysis of covariance, see Montgomery [2009].

b. Concurrent Lines In this section, all M intercepts are equal, $\beta_{01} = \beta_{02} = \dots = \beta_{0M}$, but the slopes may differ. The reduced model is

$$y = \beta_0 + \beta_1x + \beta_2Z_1 + \beta_3Z_2 + \dots + \beta_M D_{M-1} + \varepsilon$$

where $Z_k = xD_k, k = 1, 2, \dots, M - 1$. The residual sum of squares from this model is $SS_{\text{Res}}(RM)$ with $df_{RM} = n - (M + 1)$ degrees of freedom. Note that we are assuming concurrence at the origin. The more general case of concurrence at an arbitrary point x_0 is treated by Graybill [1976] and Seber [1977].

c. Coincident Lines In this case both the M slopes and the M intercepts are the same, $\beta_{01} = \beta_{02} = \dots = \beta_{0M}$, and $\beta_{11} = \beta_{12} = \dots = \beta_{1M}$. The reduced model is simply

$$y = \beta_0 + \beta_1 x + \varepsilon$$

and the residual sum of squares $SS_{\text{Res}}(RM)$ has $df_{RM} = n - 2$ degrees of freedom. Indicator variables are not necessary in the test of coincidence, but we include this case for completeness. ■

8.2 COMMENTS ON THE USE OF INDICATOR VARIABLES

8.2.1 Indicator Variables versus Regression on Allocated Codes

Another approach to the treatment of a qualitative variable in regression is to measure the levels of the variable by an allocated code. Recall Example 8.3, where an electric utility is investigating the effect of size of house and type of air conditioning system on residential electricity consumption. Instead of using three indicator variables to represent the four levels of the qualitative factor type of air conditioning system, we could use one quantitative factor, x_2 , with the following allocated code:

Type of Air Conditioning System	x_2
No air conditioning	1
Window units	2
Heat pumps	3
Central air conditioning	4

We may now fit the regression model

$$y = \beta_0 + \beta_1 x_1 + \beta_2 x_2 + \varepsilon \tag{8.14}$$

where x_1 is the size of the house. This model implies that

$$\begin{aligned} E(y|x_1, \text{no air conditioning}) &= \beta_0 + \beta_1 x_1 + \beta_2 \\ E(y|x_1, \text{window units}) &= \beta_0 + \beta_1 x_1 + 2\beta_2 \\ E(y|x_1, \text{heat pump}) &= \beta_0 + \beta_1 x_1 + 3\beta_2 \\ E(y|x_1, \text{central air conditioning}) &= \beta_0 + \beta_1 x_1 + 4\beta_2 \end{aligned}$$

A direct consequence of this is that

$$\begin{aligned}
 & E(y|x_1, \text{central air conditioning}) - E(y|x_1, \text{heat pump}) \\
 &= E(y|x_1, \text{heat pump}) - E(y|x_1, \text{window units}) \\
 &= E(y|x_1, \text{window units}) - E(y|x_1, \text{no air conditioning}) \\
 &= \beta_2
 \end{aligned}$$

which may be quite unrealistic. The allocated codes impose a particular metric on the levels of the qualitative factor. Other choices of the allocated code would imply different distances between the levels of the qualitative factor, but there is no guarantee that any particular allocated code leads to a spacing that is appropriate.

Indicator variables are more informative for this type problem because they do not force any particular metric on the levels of the qualitative factor. Furthermore, regression using indicator variables always leads to a larger R^2 than does regression on allocated codes (e.g., see Searle and Udell [1970]).

8.2.2 Indicator Variables as a Substitute for a Quantitative Regressor

Quantitative regressors can also be represented by indicator variables. Sometimes this is necessary because it is difficult to collect accurate information on the quantitative regressor. Consider the electric power usage study in Example 8.3 and suppose that a second quantitative regressor, household income, is included in the analysis. Because it is difficult to obtain this information precisely, the quantitative regressor income may be collected by grouping income into classes such as

\$0 to \$19,999
 \$20,000 to \$39,999
 \$40,000 to \$59,999
 \$60,000 to \$79,999
 \$80,000 and over

We may now represent the factor “income” in the model by using four indicator variables.

One disadvantage of this approach is that more parameters are required to represent the information content of the quantitative factor. In general, if the quantitative regressor is grouped into a classes, $a - 1$ parameters will be required, while only one parameter would be required if the original quantitative regressor is used. Thus, treating a quantitative factor as a qualitative one increases the complexity of the model. This approach also reduces the degrees of freedom for error, although if the data are numerous, this is not a serious problem. An advantage of the indicator variable approach is that it does not require the analyst to make any prior assumptions about the functional form of the relationship between the response and the regressor variable.

8.3 REGRESSION APPROACH TO ANALYSIS OF VARIANCE

The **analysis of variance** is a technique frequently used to analyze data from **planned** or **designed experiments**. Although special computing procedures are generally used for analysis of variance, any analysis-of-variance problem can also be treated as a linear regression problem. Ordinarily we do not recommend that regression methods be used for analysis of variance because the specialized computing techniques are usually quite efficient. However, there are some analysis-of-variance situations, particularly those involving unbalanced designs, where the regression approach is helpful. Furthermore, many analysts are unaware of the close connection between the two procedures. Essentially, any analysis-of-variance problem can be treated as a regression problem in which all of the regressors are indicator variables.

In this section we illustrate the regression alternative to the one-way classification or single-factor analysis of variance. For further examples of the relationship between regression and analysis of variance, see Draper and Smith [1998], Montgomery [2009], Schilling [1974a, b], and Seber [1977].

The model for the one-way classification analysis of variance is

$$y_{ij} = \mu + \tau_i + \varepsilon_{ij}, \quad i = 1, 2, \dots, k, \quad j = 1, 2, \dots, n \quad (8.15)$$

where Y_{ij} is the j th observation for the i th **treatment** or **factor level**, μ is a parameter common to all k treatments (usually called the **grand mean**), τ_i is a parameter that represents the effect of the i th treatment, and ε_{ij} is an NID($0, \sigma^2$) error component. It is customary to define the treatment effects in the balanced case (i.e., an equal number of observations per treatment) as

$$\tau_1 + \tau_2 + \dots + \tau_k = 0$$

Furthermore, the mean of the i th treatment is $\mu_i = \mu + \tau_i$, $i = 1, 2, \dots, k$. In the fixed-effects (or model I) case, the analysis of variance is used to test the hypothesis that all k population means are equal, or equivalently,

$$\begin{aligned} H_0: \tau_1 = \tau_2 = \dots = \tau_k = 0 \\ H_1: \tau_i \neq 0 \quad \text{for at least one } i \end{aligned} \quad (8.16)$$

Table 8.4 displays the usual single-factor analysis of variance. We have a true error term in this case, as opposed to a residual term, because the replication allows a model-independent estimate of error. The test statistic F_0 is compared to $F_{\alpha, k-1, k(n-1)}$. If F_0 exceeds this critical value, the null hypothesis H_0 in Eq. (8.16) is rejected; that is, we conclude that the k treatment means are not identical. Note that in Table 8.4 we have employed the usual “dot subscript” notation associated with analysis of variance. That is, the average of the n observations in the i th treatment is

$$\bar{y}_i = \frac{1}{n} \sum_{j=1}^n y_{ij}, \quad i = 1, 2, \dots, k$$

TABLE 8.4 One-Way Analysis of Variance

Degrees of Variation	Sum of Squares	Degrees of Freedom	Mean Square	F_0
Treatments	$n \sum_{i=1}^k (\bar{y}_i - \bar{y}_{..})^2$	$k - 1$	$\frac{SS_{\text{Treatments}}}{k - 1}$	$\frac{MS_{\text{Treatments}}}{MS_{\text{Res}}}$
Error	$\sum_{i=1}^k \sum_{j=1}^n (y_{ij} - \bar{y}_i)^2$	$k(n - 1)$	$\frac{SS_{\text{Res}}}{k(n - 1)}$	
Total	$\sum_{i=1}^k \sum_{j=1}^n (y_{ij} - \bar{y}_{..})^2$	$kn - 1$		

and the grand average is

$$\bar{y}_{..} = \frac{1}{kn} \sum_{i=1}^k \sum_{j=1}^n y_{ij}$$

To illustrate the connection between the single-factor fixed-effects analysis of variance and regression, suppose that we have $k = 3$ treatments, so that Eq. (8.15) becomes

$$y_{ij} = \mu + \tau_i + \varepsilon_{ij}, \quad i = 1, 2, 3, \quad j = 1, 3, \dots, n \quad (8.17)$$

These three treatments may be viewed as three levels of a **qualitative factor**, and they can be handled using indicator variables. Specifically a qualitative factor with three levels would require two indicator variables defined as follows:

$$x_1 = \begin{cases} 1 & \text{if the observation is from treatment 1} \\ 0 & \text{otherwise} \end{cases}$$

$$x_2 = \begin{cases} 1 & \text{if the observation is from treatment 2} \\ 0 & \text{otherwise} \end{cases}$$

Therefore, the regression model becomes

$$y_{ij} = \beta_0 + \beta_1 x_{1j} + \beta_2 x_{2j} + \varepsilon_{ij}, \quad i = 1, 2, 3, \quad j = 1, 2, \dots, n \quad (8.18)$$

where x_{1j} is the value of the indicator variable x_1 for observation j in treatment i and x_{2j} is the value of x_2 for observation j in treatment i .

The relationship between the parameter β_u ($u = 0, 1, 2$) in the regression model and the parameters μ and τ_i ($i = 1, 2, \dots, k$) in the analysis-of-variance model is easily determined. Consider the observations from treatment 1, for which

$$x_{1j} = 1 \quad \text{and} \quad x_{2j} = 0$$

The regression model (8.18) becomes

$$y_{1j} = \beta_0 + \beta_1(1) + \beta_2(0) + \varepsilon_{1j} = \beta_0 + \beta_1 + \varepsilon_{1j}$$

Since in the analysis-of-variance model an observation from treatment 1 is represented by $y_{1j} = \mu + \tau_1 + \varepsilon_{1j} = \mu_1 + \varepsilon_{1j}$, this implies that

$$\beta_0 + \beta_1 = \mu_1$$

Similarly, if the observations are from treatment 2, then $x_{1j} = 0, x_{2j} = 1$, and

$$y_{2j} = \beta_0 + \beta_1(0) + \beta_2(1) + \varepsilon_{2j} = \beta_0 + \beta_2 + \varepsilon_{2j}$$

Considering the analysis-of-variance model, $y_{2j} = \mu + \tau_2 + \varepsilon_{2j} = \mu_2 + \varepsilon_{2j}$, so

$$\beta_0 + \beta_2 = \mu_2$$

Finally, consider observations from treatment 3. Since $x_{1j} = x_{2j} = 0$ the regression model becomes

$$y_{3j} = \beta_0 + \beta_1(0) + \beta_2(0) + \varepsilon_{3j} = \beta_0 + \varepsilon_{3j}$$

The corresponding analysis-of-variance model is $y_{3j} = \mu + \tau_3 + \varepsilon_{3j} = \mu_3 + \varepsilon_{3j}$, so that

$$\beta_0 = \mu_3$$

Thus, in the regression model formulation of the single-factor analysis of variance, the regression coefficients describe comparisons of the first two treatment means μ_1 and μ_2 with the third treatment mean μ_3 . That is,

$$\beta_0 = \mu_3, \quad \beta_1 = \mu_1 - \mu_3, \quad \beta_2 = \mu_2 - \mu_3$$

In general, if there are k treatments, the regression model for the single-factor analysis of variance will require $k - 1$ indicator variables, for example,

$$y_{ij} = \beta_0 + \beta_1 x_{1j} + \beta_2 x_{2j} + \cdots + \beta_{k-1} x_{k-1,j} + \varepsilon_{ij} \quad i = 1, 2, \dots, k, \quad j = 1, 2, \dots, n \quad (8.19)$$

where

$$x_{ij} = \begin{cases} 1 & \text{if observation } j \text{ is from treatment } i \\ 0 & \text{otherwise} \end{cases}$$

The relationship between the parameters in the regression and analysis-of-variance models is

$$\begin{aligned} \beta_0 &= \mu_k \\ \beta_i &= \mu_i - \mu_k, \quad i = 1, 2, \dots, k-1 \end{aligned}$$

Thus, β_0 always estimates the mean of the k th treatment and β_i estimates the differences in means between treatment i and treatment k .

Now consider fitting the regression model for the one-way analysis of variance. Once again, suppose that we have $k = 3$ treatments and now let there be $n = 3$ observations per treatment. The \mathbf{X} matrix and \mathbf{y} vector are as follows:

$$\mathbf{y} = \begin{bmatrix} y_{11} \\ y_{12} \\ y_{13} \\ y_{21} \\ y_{22} \\ y_{23} \\ y_{31} \\ y_{32} \\ y_{33} \end{bmatrix}, \quad \mathbf{X} = \begin{array}{c} x_1 \quad x_2 \\ \begin{bmatrix} 1 & 1 & 0 \\ 1 & 1 & 0 \\ 1 & 1 & 0 \\ 1 & 0 & 1 \\ 1 & 0 & 1 \\ 1 & 0 & 1 \\ 1 & 0 & 0 \\ 1 & 0 & 0 \\ 1 & 0 & 0 \end{bmatrix} \end{array}$$

Notice that the \mathbf{X} matrix consists entirely of 0's and 1's. This is a characteristic of the regression formulation of any analysis-of-variance model. The least-squares normal equations are

$$(\mathbf{X}'\mathbf{X})\hat{\boldsymbol{\beta}} = \mathbf{X}'\mathbf{y}$$

or

$$\begin{bmatrix} 9 & 3 & 3 \\ 3 & 3 & 0 \\ 3 & 0 & 3 \end{bmatrix} \begin{bmatrix} \hat{\beta}_0 \\ \hat{\beta}_1 \\ \hat{\beta}_2 \end{bmatrix} = \begin{bmatrix} y_{..} \\ y_{.1} \\ y_{.2} \end{bmatrix}$$

where y_i is the total of all observations in treatment i and $y_{..}$ is the grand total of all nine observations (i.e., $y_{..} = y_{.1} + y_{.2} + y_{.3}$). The solution to the normal equations is

$$\hat{\beta}_0 = \bar{y}_{..} - \bar{y}_{.1} - \bar{y}_{.2} = \bar{y}_{.3}, \quad \hat{\beta}_1 = \bar{y}_{.1} - \bar{y}_{.3}, \quad \hat{\beta}_2 = \bar{y}_{.2} - \bar{y}_{.3}.$$

The extra-sum-of-squares method may be used to test for differences in treatment means. For the full model the regression sum of squares is

$$\begin{aligned} SS_R(\hat{\beta}_0, \hat{\beta}_1, \hat{\beta}_2) &= \hat{\boldsymbol{\beta}}'\mathbf{X}'\mathbf{y} = [\bar{y}_{.3}, \bar{y}_{.1} - \bar{y}_{.3}, \bar{y}_{.2} - \bar{y}_{.3}] \begin{bmatrix} y_{..} \\ y_{.1} \\ y_{.2} \end{bmatrix} \\ &= y_{..}\bar{y}_{.3} + y_{.1}(\bar{y}_{.1} - \bar{y}_{.3}) + y_{.2}(\bar{y}_{.2} - \bar{y}_{.3}) \\ &= (y_{.1} + y_{.2} + y_{.3})\bar{y}_{.3} + y_{.1}(\bar{y}_{.1} - \bar{y}_{.3}) + y_{.2}(\bar{y}_{.2} - \bar{y}_{.3}) \\ &= \bar{y}_{.1}y_{.1} + \bar{y}_{.2}y_{.2} + \bar{y}_{.3}y_{.3} \\ &= \sum_{i=1}^3 \frac{y_{.i}^2}{3} \end{aligned}$$

with three degrees of freedom. The residual error sum of squares for the full model is

$$\begin{aligned}
 SS_{\text{Res}} &= \sum_{i=1}^3 \sum_{j=1}^3 y_{ij}^2 - SS_{\text{R}}(\beta_0, \beta_1, \beta_2) \\
 &= \sum_{i=1}^3 \sum_{j=1}^3 y_{ij}^2 - \sum_{i=1}^3 \frac{y_i^2}{3} \\
 &= \sum_{i=1}^3 \sum_{j=1}^3 (y_{ij} - \bar{y}_i)^2
 \end{aligned} \tag{8.20}$$

with $9 - 3 = 6$ degrees of freedom. Note that Eq. (8.20) is the error sum of squares in the analysis-of-variance table (Table 8.4) for $k = n = 3$.

Testing for differences in treatment means is equivalent to testing

$$H_0: \tau_1 = \tau_2 = \tau_3 = 0$$

$$H_1: \text{at least one } \tau_i \neq 0$$

If H_0 is true, the parameters in the regression model become

$$\beta_0 = \mu, \quad \beta_1 = 0, \quad \beta_2 = 0$$

Therefore, the reduced model contains only one parameter, that is,

$$y_{ij} = \beta_0 + \varepsilon_{ij}$$

The estimate of β_0 in the reduced model is $\hat{\beta}_0 = \bar{y}_{..}$, and the single-degree-of-freedom regression sum of squares for this model is

$$SS_{\text{R}}(\beta_0) = \frac{y_{..}^2}{9}$$

The sum of squares for testing for equality of treatment means is the difference in regression sums of squares between the full and reduced models, or

$$\begin{aligned}
 SS_{\text{R}}(\beta_1, \beta_2 | \beta_0) &= SS_{\text{R}}(\beta_0, \beta_1, \beta_2) - SS_{\text{R}}(\beta_0) \\
 &= \sum_{i=1}^3 \frac{y_i^2}{3} - \frac{y_{..}^2}{9} \\
 &= 3 \sum_{j=1}^3 (\bar{y}_j - \bar{y}_{..})^2
 \end{aligned} \tag{8.21}$$

This sum of squares has $3 - 1 = 2$ degrees of freedom. Note that Eq. (8.21) is the treatment sum of squares in Table 8.4 assuming that $k = n = 3$. The appropriate test statistic is

$$\begin{aligned}
 F_0 &= \frac{SS_R(\beta_1, \beta_2 | \beta_0)/2}{SS_{\text{Res}}/6} \\
 &= \frac{3 \sum_{i=1}^3 (\bar{y}_i - \bar{y}_{..})^2 / 2}{\sum_{i=1}^3 \sum_{j=1}^3 (y_{ij} - \bar{y}_i)^2 / 6} \\
 &= \frac{MS_{\text{Treatments}}}{MS_{\text{Res}}}
 \end{aligned}$$

If $H_0: \tau_1 = \tau_2 = \tau_3 = 0$ is true, then F_0 follows the $F_{2,6}$ distribution. This is the same test statistic given in the analysis-of-variance table (Table 8.4). Therefore, the regression approach is identical to the one-way analysis-of-variance procedure outlined in Table 8.4.

PROBLEMS

- 8.1** Consider the regression model (8.8) described in Example 8.3. Graph the response function for this model and indicate the role the model parameters play in determining the shape of this function.
- 8.2** Consider the regression models described in Example 8.4.
- Graph the response function associated with Eq. (8.10).
 - Graph the response function associated with Eq. (8.11).
- 8.3** Consider the delivery time data in Example 3.1. In Section 4.2.5 noted that these observations were collected in four cities, San Diego, Boston, Austin, and Minneapolis.
- Develop a model that relates delivery time y to cases x_1 , distance x_2 , and the city in which the delivery was made. Estimate the parameters of the model.
 - Is there an indication that delivery site is an important variable?
 - Analyze the residuals from this model. What conclusions can you draw regarding model adequacy?
- 8.4** Consider the automobile gasoline mileage data in Table B.3.
- Build a linear regression model relating gasoline mileage y to engine displacement x_1 and the type of transmission x_{11} . Does the type of transmission significantly affect the mileage performance?
 - Modify the model developed in part a to include an interaction between engine displacement and the type of transmission. What conclusions can you draw about the effect of the type of transmission on gasoline mileage? Interpret the parameters in this model.

- 8.5** Consider the automobile gasoline mileage data in Table B.3.
- Build a linear regression model relating gasoline mileage y to vehicle weight x_{10} and the type of transmission x_{11} . Does the type of transmission significantly affect the mileage performance?
 - Modify the model developed in part a to include an interaction between vehicle weight and the type of transmission. What conclusions can you draw about the effect of the type of transmission on gasoline mileage? Interpret the parameters in this model.
- 8.6** Consider the National Football League data in Table B.1. Build a linear regression model relating the number of games won to the yards gained rushing by opponents x_8 , the percentage of rushing plays x_7 , and a modification of the turnover differential x_5 . Specifically let the turnover differential be an indicator variable whose value is determined by whether the actual turnover differential is positive, negative, or zero. What conclusions can you draw about the effect of turnovers on the number of games won?
- 8.7** **Piecewise Linear Regression.** In Example 7.3 we showed how a linear regression model with a change in slope at some point t ($x_{\min} < t < x_{\max}$) could be fitted using splines. Develop a formulation of the piecewise linear regression model using indicator variables. Assume that the function is continuous at point t .
- 8.8** **Continuation of Problem 8.7.** Show how indicator variables can be used to develop a piecewise linear regression model with a discontinuity at the join point t .
- 8.9** Suppose that a one-way analysis of variance involves four treatments but that a different number of observations (e.g., n_i) has been taken under each treatment. Assuming that $n_1 = 3$, $n_2 = 2$, $n_3 = 4$, and $n_4 = 3$, write down the \mathbf{y} vector and \mathbf{X} matrix for analyzing these data as a multiple regression model. Are any complications introduced by the unbalanced nature of these data?
- 8.10** **Alternate Coding Schemes for the Regression Approach to Analysis of Variance.** Consider Eq. (8.18), which represents the regression model corresponding to an analysis of variance with three treatments and n observations per treatment. Suppose that the indicator variables x_1 and x_2 are defined as

$$x_1 = \begin{cases} 1 & \text{if observation is from treatment 1} \\ -1 & \text{if observation is from treatment 2} \\ 0 & \text{otherwise} \end{cases}$$

$$x_2 = \begin{cases} 1 & \text{if observation is from treatment 2} \\ -1 & \text{if observation is from treatment 3} \\ 0 & \text{otherwise} \end{cases}$$

- Show that the relationship between the parameters in the regression and analysis-of-variance models is

$$\beta_0 = \frac{\mu_1 + \mu_2 + \mu_3}{3} = \bar{\mu}$$

$$\beta_1 = \mu_1 - \bar{\mu}, \quad \beta_2 = \mu_2 - \bar{\mu}$$

- b. Write down the \mathbf{y} vector and \mathbf{X} matrix.
- c. Develop an appropriate sum of squares for testing the hypothesis $H_0: \tau_1 = \tau_2 = \tau_3 = 0$. Is this the usual treatment sum of squares in the one-way analysis of variance?

8.11 Montgomery [2009] presents an experiment concerning the tensile strength of synthetic fiber used to make cloth for men’s shirts: The strength is thought to be affected by the percentage of cotton in the fiber. The data are shown below.

Percentage of Cotton	Tensile Strength				
15	7	7	15	11	9
20	12	17	12	18	18
25	14	18	18	19	19
30	19	25	22	19	23
35	7	10	11	15	11

- a. Write down the \mathbf{y} vector and \mathbf{X} matrix for the corresponding regression model.
- b. Find the least-squares estimates of the model parameters.
- c. Find a point estimate of the difference in mean strength between 15% and 25% cotton.
- d. Test the hypothesis that the mean tensile strength is the same for all five cotton percentages.

8.12 Two-Way Analysis of Variance. Suppose that two different sets of treatments are of interest. Let y_{ijk} be the k th observation level i of the first treatment type and level j of the second treatment type. The two-way analysis-of-variance model is

$$y_{ijk} = \mu + \tau_i + \gamma_j + (\tau\gamma)_{ij} + \varepsilon_{ijk}$$

$$i = 1, 2, \dots, a, \quad j = 1, 2, \dots, b, \quad k = 1, 2, \dots, n$$

where τ_i is the effect of level i of the first treatment type, γ_j is the effect of level j of the second treatment type, $(\tau\gamma)_{ij}$ is an interaction effect between the two treatment types, and ε_{ijk} is an $\text{NID}(0, \sigma^2)$ random-error component.

- a. For the case $a = b = n = 2$, write down a regression model that corresponds to the two-way analysis of variance.
- b. What are the \mathbf{y} vector and \mathbf{X} matrix for this regression model?
- c. Discuss how the regression model could be used to test the hypotheses $H_0: \tau_1 = \tau_2 = 0$ (treatment type 1 means are equal), $H_0: \gamma_1 = \gamma_2 = 0$ (treatment

type 2 means are equal), and $H_0: (\tau\gamma)_{11} = (\tau\gamma)_{12} = (\tau\gamma)_{22} = 0$ (no interaction between treatment types).

- 8.13** Table B.11 presents data on the quality of Pinot Noir wine.
- Build a regression model relating quality y to flavor x_4 that incorporates the region information given in the last column. Does the region have an impact on wine quality?
 - Perform a residual analysis for this model and comment on model adequacy.
 - Are there any outliers or influential observations in this data set?
 - Modify the model in part a to include interaction terms between flavor and the region variables. Is this model superior to the one you found in part a?
- 8.14** Using the wine quality data from Table B.11, fit a model relating wine quality y to flavor x_4 using region as an allocated code, taking on the values shown in the table (1,2,3). Discuss the interpretation of the parameters in this model. Compare the model to the one you built using indicator variables in Problem 8.13.
- 8.15** Consider the life expectancy data given in Table B.16. Create an indicator variable for gender. Perform a thorough analysis of the overall average life expectancy. Discuss the results of this analysis relative to your previous analyses of these data.
- 8.16** Smith et al. [1992] discuss a study of the ozone layer over the Antarctic. These scientists developed a measure of the degree to which oceanic phytoplankton production is inhibited by exposure to ultraviolet radiation (UVB). The response is INHIBIT. The regressors are UVB and SURFACE, which is depth below the ocean's surface from which the sample was taken.

The data follow.

Location	INHIBIT	UVB	SURFACE
1	0.00	0.00	Deep
2	1.00	0.00	Deep
3	6.00	0.01	Deep
4	7.00	0.01	Surface
5	7.00	0.02	Surface
6	7.00	0.03	Surface
7	9.00	0.04	Surface
8	9.50	0.01	Deep
9	10.00	0.00	Deep
10	11.00	0.03	Surface
11	12.50	0.03	Surface
12	14.00	0.01	Deep
13	20.00	0.03	Deep
14	21.00	0.04	Surface
15	25.00	0.02	Deep
16	39.00	0.03	Deep
17	59.00	0.03	Deep

Perform an analysis of these data. Discuss your results.

- 8.17** Table B.17 contains hospital patient satisfaction data. Fit an appropriate regression model to the satisfaction response using age and severity as the regressors and account for the medical versus surgical classification of each patient with an indicator variable. Has adding the indicator variable improved the model? Is there any evidence to support a claim that medical and surgical patients differ in their satisfaction?
- 8.18** Consider the fuel consumption data in Table B.18. Regressor x_1 is an indicator variable. Perform a thorough analysis of these data. What conclusions do you draw from this analysis?
- 8.19** Consider the wine quality of young red wines data in Table B.19. Regressor x_1 is an indicator variable. Perform a thorough analysis of these data. What conclusions do you draw from this analysis?
- 8.20** Consider the methanol oxidation data in Table B.20. Perform a thorough analysis of these data. What conclusions do you draw from this analysis?

CHAPTER 9

MULTICOLLINEARITY

9.1 INTRODUCTION

The use and interpretation of a multiple regression model often depends explicitly or implicitly on the estimates of the individual regression coefficients. Some examples of inferences that are frequently made include the following:

1. Identifying the relative effects of the regressor variables
2. Prediction and/or estimation
3. Selection of an appropriate set of variables for the model

If there is no linear relationship between the regressors, they are said to be **orthogonal**. When the regressors are orthogonal, inferences such as those illustrated above can be made relatively easily. Unfortunately, in most applications of regression, the regressors are not orthogonal. Sometimes the lack of orthogonality is not serious. However, in some situations the regressors are nearly perfectly linearly related, and in such cases the inferences based on the regression model can be misleading or erroneous. When there are **near-linear dependencies** among the regressors, the problem of **multicollinearity** is said to exist.

This chapter will extend the preliminary discussion of multicollinearity begun in Chapter 3 and discuss a variety of problems and techniques related to this problem. Specifically we will examine the causes of multicollinearity, some of its specific effects on inference, methods of detecting the presence of multicollinearity, and some techniques for dealing with the problem.

9.2 SOURCES OF MULTICOLLINEARITY

We write the multiple regression model as

$$\mathbf{y} = \mathbf{X}\boldsymbol{\beta} + \boldsymbol{\varepsilon}$$

where \mathbf{y} is an $n \times 1$ vector of responses, \mathbf{X} is an $n \times p$ matrix of the regressor variables, $\boldsymbol{\beta}$ is a $p \times 1$ vector of unknown constants, and $\boldsymbol{\varepsilon}$ is an $n \times 1$ vector of random errors, with $\varepsilon_i \sim \text{NID}(0, \sigma^2)$. It will be convenient to assume that the regressor variables and the response have been centered and scaled to unit length, as in Section 3.9. Consequently, $\mathbf{X}'\mathbf{X}$ is a $p \times p$ matrix of correlations[†] between the regressors and $\mathbf{X}'\mathbf{y}$ is a $p \times 1$ vector of correlations between the regressors and the response.

Let the j th column of the \mathbf{X} matrix be denoted \mathbf{X}_j , so that $\mathbf{X} = [\mathbf{X}_1, \mathbf{X}_2, \dots, \mathbf{X}_p]$. Thus, \mathbf{X}_j contains the n levels of the j th regressor variable. We may formally define multicollinearity in terms of the linear dependence of the columns of \mathbf{X} . The vectors $\mathbf{X}_1, \mathbf{X}_2, \dots, \mathbf{X}_p$ are linearly dependent if there is a set of constants t_1, t_2, \dots, t_p , not all zero, such that[‡]

$$\sum_{j=1}^p t_j \mathbf{X}_j = \mathbf{0} \quad (9.1)$$

If Eq. (9.1) holds exactly for a subset of the columns of \mathbf{X} , then the rank of the $\mathbf{X}'\mathbf{X}$ matrix is less than p and $(\mathbf{X}'\mathbf{X})^{-1}$ does not exist. However, suppose that Eq. (9.1) is approximately true for some subset of the columns of \mathbf{X} . Then there will be a near-linear dependency in $\mathbf{X}'\mathbf{X}$ and the problem of multicollinearity is said to exist. Note that multicollinearity is a form of ill-conditioning in the $\mathbf{X}'\mathbf{X}$ matrix. Furthermore, the problem is one of degree, that is, every data set will suffer from multicollinearity to some extent unless the columns of \mathbf{X} are orthogonal ($\mathbf{X}'\mathbf{X}$ is a diagonal matrix). Generally this will happen only in a designed experiment. As we shall see, the presence of multicollinearity can make the usual least-squares analysis of the regression model dramatically inadequate.

There are four primary **sources of multicollinearity**:

1. The data collection method employed
2. Constraints on the model or in the population
3. Model specification
4. An overdefined model

It is important to understand the differences among these sources of multicollinearity, as the recommendations for analysis of the data and interpretation of the resulting model depend to some extent on the cause of the problem (see Mason, Gunst, and Webster [1975] for further discussion of the source of multicollinearity).

[†]It is customary to refer to the off-diagonal elements of $\mathbf{X}'\mathbf{X}$ as correlation coefficients, although the regressors are not necessarily random variables.

[‡]If the regressors are not centered, then 0 in Eq. (9.1) becomes a vector of constants m , not all necessarily equal to 0.

The **data collection method** can lead to multicollinearity problems when the analyst samples only a subspace of the region of the regressors defined (approximately) by Eq. (9.1). For example, consider the soft drink delivery time data discussed in Example 3.1. The space of the regressor variables “cases” and “distance,” as well as the subspace of this region that has been sampled, is shown in the matrix of scatterplots, Figure 3.4. Note that the sample (cases, distance) pairs fall approximately along a straight line. In general, if there are more than two regressors, the data will lie approximately along a hyperplane defined by Eq. (9.1). In this example, observations with a small number of cases generally also have a short distance, while observations with a large number of cases usually also have a long distance. Thus, cases and distance are positively correlated, and if this positive correlation is strong enough, a multicollinearity problem will occur. Multicollinearity caused by the sampling technique is not inherent in the model or the population being sampled. For example, in the delivery time problem we could collect data with a small number of cases and a long distance. There is nothing in the physical structure of the problem to prevent this.

Constraints on the model or in the population being sampled can cause multicollinearity. For example, suppose that an electric utility is investigating the effect of family income (x_1) and house size (x_2) on residential electricity consumption. The levels of the two regressor variables obtained in the sample data are shown in Figure 9.1. Note that the data lie approximately along a straight line, indicating a potential multicollinearity problem. In this example a physical constraint in the population has caused this phenomenon, namely, families with higher incomes generally have larger homes than families with lower incomes. When physical constraints such as this are present, multicollinearity will exist **regardless** of the sampling method employed. Constraints often occur in problems involving production or chemical processes, where the regressors are the components of a product, and these components add to a constant.

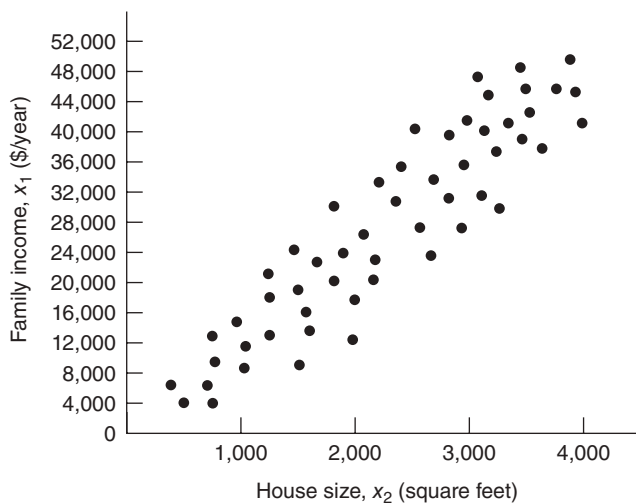

Figure 9.1 Levels of family income and house size for a study on residential electricity consumption.

Multicollinearity may also be induced by the **choice of model**. For example, we know from Chapter 7 that adding polynomial terms to a regression model causes ill-conditioning in $\mathbf{X}'\mathbf{X}$. Furthermore, if the range of x is small, adding an x^2 term can result in significant multicollinearity. We often encounter situations such as these where two or more regressors are nearly linearly dependent, and retaining all these regressors may contribute to multicollinearity. In these cases some subset of the regressors is usually preferable from the standpoint of multicollinearity.

An **overdefined model** has more regressor variables than observations. These models are sometimes encountered in medical and behavioral research, where there may be only a small number of subjects (sample units) available, and information is collected for a large number of regressors on each subject. The usual approach to dealing with multicollinearity in this context is to eliminate some of the regressor variables from consideration. Mason, Gunst, and Webster [1975] give three specific recommendations: (1) redefine the model in terms of a smaller set of regressors, (2) perform preliminary studies using only subsets of the original regressors, and (3) use principal-component-type regression methods to decide which regressors to remove from the model. The first two methods ignore the interrelationships between the regressors and consequently can lead to unsatisfactory results. Principal-component regression will be discussed in Section 9.5.4, although not in the context of overdefined models.

9.3 EFFECTS OF MULTICOLLINEARITY

The presence of multicollinearity has a number of potentially serious effects on the least-squares estimates of the regression coefficients. Some of these effects may be easily demonstrated. Suppose that there are only two regressor variables, x_1 and x_2 . The model, assuming that x_1 , x_2 , and y are scaled to unit length, is

$$y = \beta_1 x_1 + \beta_2 x_2 + \varepsilon$$

and the least-squares normal equations are

$$(\mathbf{X}'\mathbf{X})\hat{\boldsymbol{\beta}} = \mathbf{X}'\mathbf{y}$$

$$\begin{bmatrix} 1 & r_{12} \\ r_{12} & 1 \end{bmatrix} \begin{bmatrix} \hat{\beta}_1 \\ \hat{\beta}_2 \end{bmatrix} = \begin{bmatrix} r_{1y} \\ r_{2y} \end{bmatrix}$$

where r_{12} is the simple correlation between x_1 and x_2 and r_{jy} is the simple correlation between x_j and y , $j = 1, 2$. Now the inverse of $(\mathbf{X}'\mathbf{X})$ is

$$\mathbf{C} = (\mathbf{X}'\mathbf{X})^{-1} = \begin{bmatrix} \frac{1}{1-r_{12}^2} & \frac{-r_{12}}{1-r_{12}^2} \\ \frac{-r_{12}}{1-r_{12}^2} & \frac{1}{1-r_{12}^2} \end{bmatrix} \quad (9.2)$$

and the estimates of the regression coefficients are

$$\hat{\beta}_1 = \frac{r_{1y} - r_{12}r_{2y}}{1 - r_{12}^2}, \quad \hat{\beta}_2 = \frac{r_{2y} - r_{12}r_{1y}}{1 - r_{12}^2}$$

If there is strong multicollinearity between x_1 and x_2 , then the correlation coefficient r_{12} will be large. From Eq. (9.2) we see that as $|r_{12}| \rightarrow 1$, $\text{Var}(\hat{\beta}_j) = C_{jj}\sigma^2 \rightarrow \infty$ and $\text{Cov}(\hat{\beta}_1, \hat{\beta}_2) = C_{12}\sigma^2 \rightarrow \pm\infty$ depending on whether $r_{12} \rightarrow +1$ or $r_{12} \rightarrow -1$. Therefore, strong multicollinearity between x_1 and x_2 results in **large variances and covariances** for the least-squares estimators of the regression coefficients.[†] This implies that different samples taken at the same x levels could lead to widely different estimates of the model parameters.

When there are more than two regressor variables, multicollinearity produces similar effects. It can be shown that the diagonal elements of the $\mathbf{C} = (\mathbf{X}'\mathbf{X})^{-1}$ matrix are

$$C_{jj} = \frac{1}{1 - R_j^2}, \quad j = 1, 2, \dots, p \quad (9.3)$$

where R_j^2 is the coefficient of multiple determination from the regression of x_j on the remaining $p - 1$ regressor variables. If there is strong multicollinearity between x_j and any subset of the other $p - 1$, regressors, then the value of R_j^2 will be close to unity. Since the variance of $\hat{\beta}_j$ is $\text{Var}(\hat{\beta}_j) = C_{jj}\sigma^2 = (1 - R_j^2)^{-1}\sigma^2$, strong multicollinearity implies that the variance of the least-squares estimate of the regression coefficient β_j is very large. Generally, the covariance of $\hat{\beta}_i$ and $\hat{\beta}_j$ will also be large if the regressors x_i and x_j are involved in a multicollinear relationship.

Multicollinearity also tends to produce least-squares estimates $\hat{\beta}_j$ that are **too large** in absolute value. To see this, consider the squared distance from $\hat{\beta}$ to the true parameter vector β , for example,

$$L_1^2 = (\hat{\beta} - \beta)' (\hat{\beta} - \beta)$$

The expected squared distance, $E(L_1^2)$, is

$$\begin{aligned} E(L_1^2) &= E(\hat{\beta} - \beta)' (\hat{\beta} - \beta) = \sum_{j=1}^p E(\hat{\beta}_j - \beta_j)^2 \\ &= \sum_{j=1}^p \text{Var}(\hat{\beta}_j) = \sigma^2 \text{Tr}(\mathbf{X}'\mathbf{X})^{-1} \end{aligned} \quad (9.4)$$

where the trace of a matrix (abbreviated Tr) is just the sum of the main diagonal elements. When there is multicollinearity present, some of the eigenvalues of $\mathbf{X}'\mathbf{X}$ will be small. Since the trace of a matrix is also equal to the sum of its eigenvalues, Eq. (9.4) becomes

$$E(L_1^2) = \sigma^2 \sum_{j=1}^p \frac{1}{\lambda_j} \quad (9.5)$$

[†]Multicollinearity is not the only cause of large variances and covariances of regression coefficients.

where $\lambda_j > 0$, $j = 1, 2, \dots, p$, are the eigenvalues of $\mathbf{X}'\mathbf{X}$. Thus, if the $\mathbf{X}'\mathbf{X}$ matrix is ill-conditioned because of multicollinearity, at least one of the λ_j will be small, and Eq. (9.5) implies that the distance from the least-squares estimate $\hat{\boldsymbol{\beta}}$ to the true parameters $\boldsymbol{\beta}$ may be large. Equivalently we can show that

$$E(L_1^2) = E(\hat{\boldsymbol{\beta}} - \boldsymbol{\beta})'(\hat{\boldsymbol{\beta}} - \boldsymbol{\beta}) = E(\hat{\boldsymbol{\beta}}'\hat{\boldsymbol{\beta}} - 2\hat{\boldsymbol{\beta}}'\boldsymbol{\beta} + \boldsymbol{\beta}'\boldsymbol{\beta})$$

or

$$E(\hat{\boldsymbol{\beta}}'\hat{\boldsymbol{\beta}}) = \boldsymbol{\beta}'\boldsymbol{\beta} + \sigma^2 \text{Tr}(\mathbf{X}'\mathbf{X})^{-1}$$

That is, the vector $\hat{\boldsymbol{\beta}}$ is generally longer than the vector $\boldsymbol{\beta}$. This implies that the method of least squares produces estimated regression coefficients that are too large in absolute value.

While the method of least squares will generally produce poor estimates of the individual model parameters when strong multicollinearity is present, this does not necessarily imply that the fitted model is a poor predictor. If predictions are confined to regions of the x space where the multicollinearity holds approximately, the fitted model often produces satisfactory predictions. This can occur because the linear combination $\sum_{j=1}^p \beta_j x_{ij}$ may be estimated quite well, even though the individual parameters β_j are estimated poorly. That is, if the original data lie approximately along the hyperplane defined by Eq. (9.1), then future observations that also lie near this hyperplane can often be precisely predicted despite the inadequate estimates of the individual model parameters.

Example 9.1 The Acetylene Data

Table 9.1 presents data concerning the percentage of conversion of n -heptane to acetylene and three explanatory variables (Himmelblau [1970], Kunugi, Tamura, and Naito [1961], and Marquardt and Snee [1975]). These are typical chemical process data for which a full quadratic response surface in all three regressors is often considered to be an appropriate tentative model. A plot of contact time versus reactor temperature is shown in Figure 9.2. Since these two regressors are highly correlated, there are potential multicollinearity problems in these data.

The full quadratic model for the acetylene data is

$$P = \gamma_0 + \gamma_1 T + \gamma_2 H + \gamma_3 C + \gamma_{12} TH + \gamma_{13} TC + \gamma_{23} HC \\ + \gamma_{11} T^2 + \gamma_{22} H^2 + \gamma_{33} C^2 + \varepsilon$$

where

P = percentage of conversion

$$T = \frac{\text{temperature} - 1212.50}{80.623}$$

$$H = \frac{H_2 (n\text{-heptane}) - 12.44}{5.662}$$

TABLE 9.1 Acetylene Data for Example 9.1

Observation	Conversion of <i>n</i> -Heptane to Acetylene (%)	Reactor Temperature (°C)	Ratio of H ₂ to <i>n</i> -Heptane (mole ratio)	Contact Time (sec)
1	49.0	1300	7.5	0.0120
2	50.2	1300	9.0	0.0120
3	50.5	1300	11.0	0.0115
4	48.5	1300	13.5	0.0130
5	47.5	1300	17.0	0.0135
6	44.5	1300	23.0	0.0120
7	28.0	1200	5.3	0.0400
8	31.5	1200	7.5	0.0380
9	34.5	1200	11.0	0.0320
10	35.0	1200	13.5	0.0260
11	38.0	1200	17.0	0.0340
12	38.5	1200	23.0	0.0410
13	15.0	1100	5.3	0.0840
14	17.0	1100	7.5	0.0980
15	20.5	1100	11.0	0.0920
16	29.5	1100	17.0	0.0860

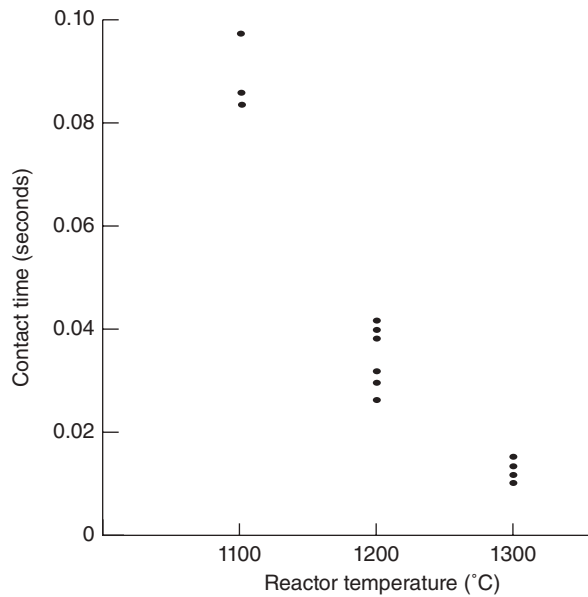
**Figure 9.2** Contact time versus reactor temperature, acetylene data. (From Marquardt and Snee [1975], with permission of the publisher.)

and

$$C = \frac{\text{contact time} - 0.0403}{0.03164}$$

Each of the original regressors has been scaled using the unit normal scaling of Section 3.9 [subtracting the average (centering) and dividing by the standard deviation]. The squared and cross-product terms are generated from the scaled linear terms. As we noted in Chapter 7, centering the linear terms is helpful in removing nonessential ill-conditioning when fitting polynomials. The least-squares fit is

$$\hat{P} = 35.897 + 4.019T + 2.781H - 8.031C - 6.457TH - 26.982TC \\ - 3.768HC - 12.54T^2 - 0.973H^2 - 11.594C^2$$

The summary statistics for this model are displayed in Table 9.2. The regression coefficients are reported in terms of both the original centered regressors and standardized regressors.

The fitted values for the six points (*A*, *B*, *E*, *F*, *I*, and *J*) that define the boundary of the regressor variable hull of contact time and reactor temperature are shown in Figure 9.3 along with the corresponding observed values of percentage of conversion. The predicted and observed values agree very closely; consequently, the model seems adequate for interpolation within the range of the original data. Now consider using the model for extrapolation. Figure 9.3 (points *C*, *D*, *G*, and *H*) also shows predictions made at the corners of the region defined by the range of the original data. These points represent relatively mild extrapolation, since the original ranges of the regressors have not been exceeded. The predicted conversions at three of the four extrapolation points are negative, an obvious impossibility. It seems that the least-squares model fits the data reasonably well but extrapolates very poorly. A likely cause of this in view of the strong apparent correlation between contact time and reactor temperature is multicollinearity. In general, if a model is to extrapolate well, good estimates of the individual coefficients are required. When multicollinearity is suspected, the least-squares estimates of the regression coefficients may be very poor. This may seriously limit the usefulness of the regression model for inference and prediction. ■

9.4 MULTICOLLINEARITY DIAGNOSTICS

Several techniques have been proposed for **detecting multicollinearity**. We will now discuss and illustrate some of these diagnostic measures. Desirable characteristics of a diagnostic procedure are that it directly reflect the degree of the multicollinearity problem and provide information helpful in determining which regressors are involved.

9.4.1 Examination of the Correlation Matrix

A very simple measure of multicollinearity is inspection of the off-diagonal elements r_{ij} in $\mathbf{X}'\mathbf{X}$. If regressors x_i and x_j are nearly linearly dependent, then $|r_{ij}|$ will

TABLE 9.2 Summary Statistics for the Least-Squares Acetylene Model

Term	Regression Coefficient	Standard Error	t_0	Standardized Regression Coefficient
Intercept	35.8971	1.0903	32.93	
T	4.0187	4.5012	0.89	0.3377
H	2.7811	0.3074	9.05	0.2337
C	-8.0311	6.0657	-1.32	-0.6749
TH	-6.4568	1.4660	-4.40	-0.4799
TC	-26.9818	21.0224	-1.28	-2.0344
HC	-3.7683	1.6554	-2.28	-0.2657
T^2	-12.5237	12.3239	-1.02	-0.8346
H^2	-0.9721	0.3746	-2.60	-0.0904
C^2	-11.5943	7.7070	-1.50	-1.0015

$MS_{Res} = 0.8126, R^2 = 0.998, F_0 = 289.72.$

When the response is standardized, $MS_{Res} = 0.00038$ for the least-squares model.

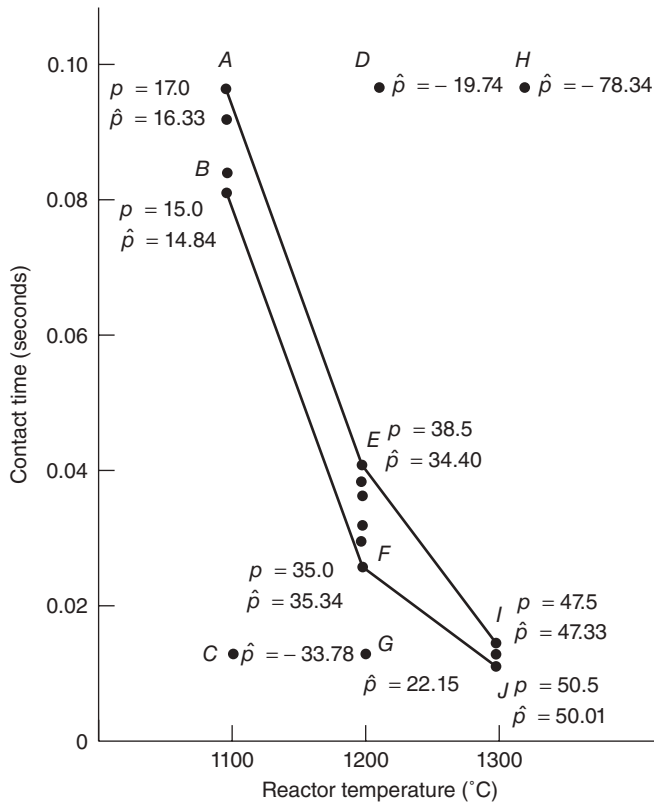

Figure 9.3 Predictions of percentage of conversion within the range of the data and extrapolation for the least-squares acetylene model. (Adapted from Marquardt and Snee [1975], with permission of the publisher.)

be near unity. To illustrate this procedure, consider the acetylene data from Example 9.1. Table 9.3 shows the nine regressor variables and the response in standardized form; that is, each of the variables has been centered by subtracting the mean for that variable and dividing by the square root of the corrected sum of squares for that variable. The $\mathbf{X}'\mathbf{X}$ matrix in correlation form for the acetylene data is

$$\mathbf{X}'\mathbf{X} = \begin{bmatrix} 1.000 & 0.224 & -0.958 & -0.132 & 0.443 & 0.205 & -0.271 & 0.031 & -0.577 \\ & 1.000 & -0.240 & 0.039 & 0.192 & -0.023 & -0.148 & 0.498 & -0.224 \\ & & 1.000 & 0.194 & -0.661 & -0.274 & 0.501 & -0.018 & 0.765 \\ & & & 1.000 & -0.265 & -0.975 & 0.246 & 0.398 & 0.274 \\ & & & & 1.000 & 0.323 & -0.972 & 0.126 & -0.972 \\ & & & & & 1.000 & -0.279 & -0.374 & 0.358 \\ & & & & & & 1.000 & -0.124 & 0.874 \\ & & & & & & & 1.000 & -0.158 \\ & & & & & & & & 1.000 \end{bmatrix}$$

Symmetric

The $\mathbf{X}'\mathbf{X}$ matrix reveals the high correlation between reactor temperature (x_1) and contact time (x_3) suspected earlier from inspection of Figure 9.2, since $r_{13} = -0.958$. Furthermore, there are other large correlation coefficients between x_1x_2 and x_2x_3 , x_1x_3 and x_1^2 , and x_1^2 and x_3^2 . This is not surprising as these variables are generated from the linear terms and they involve the highly correlated regressors x_1 and x_3 . Thus, inspection of the correlation matrix indicates that there are several near-linear dependencies in the acetylene data.

Examining the simple correlations r_{ij} between the regressors is helpful in detecting near-linear dependence between **pairs of regressors** only. Unfortunately, when more than two regressors are involved in a near-linear dependence, there is no assurance that any of the pairwise correlations r_{ij} will be large. As an illustration, consider the data in Table 9.4. These data were artificially generated by Webster, Gunst, and Mason [1974]. They required that $\sum_{j=1}^4 x_{ij} = 10$ for observations 2–12, while $\sum_{j=1}^4 x_{1j} = 11$ for observation 1. Regressors 5 and 6 were obtained from a table of normal random numbers. The responses y_i were generated by the relationship

$$y_i = 10 + 2.0x_{i1} + 1.0x_{i2} + 0.2x_{i3} - 2.0x_{i4} + 3.0x_{i5} + 10.0x_{i6} + \varepsilon_i$$

where $\varepsilon_i \sim N(0, 1)$. The $\mathbf{X}'\mathbf{X}$ matrix in correlation form for these data is

$$\mathbf{X}'\mathbf{X} = \begin{bmatrix} 1.000 & 0.052 & -0.343 & -0.498 & 0.417 & -0.192 \\ & 1.000 & -0.432 & -0.371 & 0.485 & -0.317 \\ & & 1.000 & -0.355 & -0.505 & 0.494 \\ & & & 1.000 & -0.215 & -0.087 \\ & & & & 1.000 & -0.123 \\ & & & & & 1.000 \end{bmatrix}$$

Symmetric

TABLE 9.3 Standardized Acetylene Data^a

Observation, <i>i</i>	<i>y</i>	<i>x</i> ₁	<i>x</i> ₂	<i>x</i> ₃	<i>x</i> ₁ <i>x</i> ₂	<i>x</i> ₁ <i>x</i> ₃	<i>x</i> ₂ <i>x</i> ₃	<i>x</i> ₁ ²	<i>x</i> ₂ ²	<i>x</i> ₃ ²
1	.27979	.28022	-.22554	-.23106	-.33766	-.02085	.30952	.07829	-.04116	-.03452
2	.30583	.28022	-.15704	-.23106	-.25371	-.02085	.23659	.07829	-.13270	-.03452
3	.31234	.28022	-.06584	-.23514	-.14179	-.02579	.14058	.07829	-.20378	-.02735
4	.26894	.28022	.04817	-.22290	.00189	-.01098	.01960	.07829	-.21070	-.04847
5	.24724	.28022	.20777	-.21882	.19398	-.00605	-.14065	.07829	-.06745	-.05526
6	.18214	-.04003	.48139	-.23106	.52974	-.02085	-.44415	.07829	.59324	-.03452
7	.17590	-.04003	-.32577	-.00255	-.00413	.25895	.07300	-.29746	.15239	-.23548
8	-.09995	-.04003	-.22544	-.01887	-.02171	.26177	.08884	-.29746	-.04116	-.23418
9	-.03486	-.04003	-.06584	-.06784	-.04970	.27023	.08985	-.29746	-.20378	-.21822
10	-.02401	-.04003	.04817	-.11680	-.06968	.27869	.04328	-.29746	-.21070	-.18419
11	.04109	-.04003	.20777	-.05152	-.09766	.26741	.01996	-.29746	-.06745	-.22554
12	.05194	-.04003	.48139	.00561	-.14563	.25754	.08202	-.29746	.59329	-.23538
13	.45800	-.36029	-.32577	.35653	.45252	-.29615	-.46678	.32879	.15239	.24374
14	.41460	-.36029	-.22544	.47078	.29423	-.47384	-.42042	.32879	-.04116	.60000
15	-.33865	-.36029	-.06584	.42187	.04240	-.39769	-.05859	.32879	-.20378	.43527
16	-.14335	-.36029	.20777	.37285	-.38930	-.32153	-.42738	.32879	-.06745	.28861

^aThe standardized data were constructed from the centered and scaled form of the original data in Table 9.1.

TABLE 9.4 Unstandardized Regressor and Response Variables from Webster, Gunst, and Mason [1974]

Observation, i	y_i	x_{i1}	x_{i2}	x_{i3}	x_{i4}	x_{i5}	x_{i6}
1	10.006	8.000	1.000	1.000	1.000	0.541	-0.099
2	9.737	8.000	1.000	1.000	0.000	0.130	0.070
3	15.087	8.000	1.000	1.000	0.000	2.116	0.115
4	8.422	0.000	0.000	9.000	1.000	-2.397	0.252
5	8.625	0.000	0.000	9.000	1.000	-0.046	0.017
6	16.289	0.000	0.000	9.000	1.000	0.365	1.504
7	5.958	2.000	7.000	0.000	1.000	1.996	-0.865
8	9.313	2.000	7.000	0.000	1.000	0.228	-0.055
9	12.960	2.000	7.000	0.000	1.000	1.380	0.502
10	5.541	0.000	0.000	0.000	10.000	-0.798	-0.399
11	8.756	0.000	0.000	0.000	10.000	0.257	0.101
12	10.937	0.000	0.000	0.000	10.000	0.440	0.432

None of the pairwise correlations r_{ij} are suspiciously large, and consequently we have no indication of the near-linear dependence among the regressors. Generally, inspection of the r_{ij} is not sufficient for detecting anything more complex than pairwise multicollinearity.

9.4.2 Variance Inflation Factors

We observed in Chapter 3 that the diagonal elements of the $\mathbf{C} = (\mathbf{X}'\mathbf{X})^{-1}$ matrix are very useful in detecting multicollinearity. Recall from Eq. (9.3) that C_{jj} , the j th diagonal element of \mathbf{C} , can be written as $C_{jj} = (1 - R_j^2)^{-1}$, where R_j^2 is the coefficient of determination obtained when x_j is regressed on the remaining $p - 1$ regressors. If x_j is nearly orthogonal to the remaining regressors, R_j^2 is small and C_{jj} is close to unity, while if x_j is nearly linearly dependent on some subset of the remaining regressors, R_j^2 is near unity and C_{jj} is large. Since the variance of the j th regression coefficients is $C_{jj}\sigma^2$, we can view C_{jj} as the factor by which the variance of $\hat{\beta}_j$ is increased due to near-linear dependences among the regressors. In Chapter 3 we called

$$\text{VIF}_j = C_{jj} = (1 - R_j^2)^{-1}$$

the **variance inflation factor**. This terminology is due to Marquardt [1970]. The VIF for each term in the model measures the combined effect of the dependences among the regressors on the variance of that term. One or more large VIFs indicate multicollinearity. Practical experience indicates that if any of the VIFs exceeds 5 or 10, it is an indication that the associated regression coefficients are poorly estimated because of multicollinearity.

The VIFs have another interesting interpretation. The length of the normal theory confidence interval on the j th regression coefficient may be written as

$$L_j = 2(C_{jj}\sigma^2)^{1/2} t_{\alpha/2, n-p-1}$$

and the length of the corresponding interval based on an **orthogonal reference design** with the same sample size and root-mean-square (rms) values [i.e., $\text{rms} = \sum_{i=1}^n (x_{ij} - \bar{x}_j)^2 / n$ is a measure of the spread of the regressor x_j] as the original design is

$$L^* = 2\sigma t_{\alpha/2, n-p-1}$$

The ratio of these two confidence intervals is $L_j / L^* = C_{jj}^{1/2}$. Thus, the square root of the j th VIF indicates how much longer the confidence interval for the j th regression coefficient is because of multicollinearity.

The VIFs for the acetylene data are shown in panel A of Table 9.5. These VIFs are the main diagonal elements of $(\mathbf{X}'\mathbf{X})^{-1}$, assuming that the linear terms in the model are centered and the second-order terms are generated directly from the linear terms. The maximum VIF is 6565.91, so we conclude that a multicollinearity problem exists. Furthermore, the VIFs for several of the other cross-product and squared variables involving x_1 and x_3 are large. Thus, the VIFs can help identify which regressors are involved in the multicollinearity. Note that the VIFs in polynomial models are affected by centering the linear terms. Panel B of Table 9.5 shows the VIFs for the acetylene data, assuming that the linear terms are not centered. These VIFs are much larger than those for the centered data. Thus centering the linear terms in a polynomial model removes some of the nonessential ill-conditioning caused by the choice of origin for the regressors.

The VIFs for the Webster, Gunst, and Mason data are shown in panel C of Table 9.5. Since the maximum VIF is 297.14, multicollinearity is clearly indicated. Once again, note that the VIFs corresponding to the regressors involved in the multicollinearity are much larger than those for x_5 and x_6 .

9.4.3 Eigensystem Analysis of $\mathbf{X}'\mathbf{X}$

The characteristic roots or **eigenvalues** of $\mathbf{X}'\mathbf{X}$, say $\lambda_1, \lambda_2, \dots, \lambda_p$, can be used to measure the extent of multicollinearity in the data.[†] If there are one or more

TABLE 9.5 VIFs for Acetylene Data and Webster, Gunst, and Mason Data

Data, (A) Acetylene Centered Term VIF	Data, (B) Acetylene Uncentered Term VIF	Data, (C) Webster, Gunst, and Mason Term VIF
$x_1 = 374$	$x_1 = 2,856,749$	$x_1 = 181.83$
$x_2 = 1.74$	$x_2 = 10,956.1$	$x_2 = 161.40$
$x_3 = 679.11$	$x_3 = 2,017,163$	$x_3 = 265.49$
$x_1x_2 = 31.03$	$x_1x_2 = 2,501,945$	$x_4 = 297.14$
$x_1x_3 = 6565.91$	$x_1x_3 = 65.73$	$x_5 = 1.74$
$x_2x_3 = 35.60$	$x_2x_3 = 12,667.1$	$x_6 = 1.44$
$x_1^2 = 1762.58$	$x_1^2 = 9802.9$	
$x_2^2 = 3.17$	$x_2^2 = 1,428,092$	
$x_3^2 = 1158.13$	$x_3^2 = 240.36$	
Maximum VIF = 6565.91	Maximum VIF = 2,856,749	Maximum VIF = 297.14

[†]Recall that the eigenvalues of a $p \times p$ matrix \mathbf{A} are the p roots of the equation $|\mathbf{A} - \lambda\mathbf{I}| = 0$. Eigenvalues are almost always calculated by computer routines. Methods for computing eigenvalues and eigenvectors are discussed in Smith et al. [1974], Stewart [1973], and Wilkinson [1965].

near-linear dependences in the data, then one or more of the characteristic roots will be small. One or more small eigenvalues imply that there are near-linear dependences among the columns of \mathbf{X} . Some analysts prefer to examine the **condition number** of $\mathbf{X}'\mathbf{X}$, defined as

$$\kappa = \frac{\lambda_{\max}}{\lambda_{\min}} \quad (9.6)$$

This is just a measure of the spread in the eigenvalue spectrum of $\mathbf{X}'\mathbf{X}$. Generally, if the condition number is less than 100, there is no serious problem with multicollinearity. Condition numbers between 100 and 1000 imply moderate to strong multicollinearity, and if κ exceeds 1000, severe multicollinearity is indicated.

The **condition indices** of the $\mathbf{X}'\mathbf{X}$ matrix are

$$\kappa_j = \frac{\lambda_{\max}}{\lambda_j}, \quad j = 1, 2, \dots, p$$

Clearly the largest condition index is the condition number defined in Eq. (9.6). The number of condition indices that are large (say ≥ 1000) is a useful measure of the number of near-linear dependences in $\mathbf{X}'\mathbf{X}$.

The eigenvalues of $\mathbf{X}'\mathbf{X}$ for the acetylene data are $\lambda_1 = 4.2048$, $\lambda_2 = 2.1626$, $\lambda_3 = 1.1384$, $\lambda_4 = 1.0413$, $\lambda_5 = 0.3845$, $\lambda_6 = 0.0495$, $\lambda_7 = 0.0136$, $\lambda_8 = 0.0051$, and $\lambda_9 = 0.0001$. There are four very small eigenvalues, a symptom of seriously ill-conditioned data. The condition number is

$$\kappa = \frac{\lambda_{\max}}{\lambda_{\min}} = \frac{4.2048}{0.0001} = 42,048$$

which indicates severe multicollinearity. The condition indices are

$$\begin{aligned} \kappa_1 &= \frac{4.2048}{4.2048} = 1, & \kappa_2 &= \frac{4.2048}{2.1626} = 1.94, & \kappa_3 &= \frac{4.2048}{1.1384} = 3.69 \\ \kappa_4 &= \frac{4.2048}{1.0413} = 4.04, & \kappa_5 &= \frac{4.2048}{0.3845} = 10.94, & \kappa_6 &= \frac{4.2048}{0.0495} = 84 \\ \kappa_7 &= \frac{4.2048}{0.0136} = 309.18, & \kappa_8 &= \frac{4.2048}{0.0051} = 824.47, & \kappa_9 &= \frac{4.2048}{0.0001} = 42,048 \end{aligned}$$

Since one of the condition indices exceeds 1000 (and two others exceed 100), we conclude that there is at least one strong near-linear dependence in the acetylene data. Considering that x_1 is highly correlated with x_3 and the model contains both quadratic and cross-product terms in x_1 and x_3 , this is, of course, not surprising.

The eigenvalues for the Webster, Gunst, and Mason data are $\lambda_1 = 2.4288$, $\lambda_2 = 1.5462$, $\lambda_3 = 0.9221$, $\lambda_4 = 0.7940$, $\lambda_5 = 0.3079$, and $\lambda_6 = 0.0011$. The small eigenvalue indicates the near-linear dependence in the data. The condition number is

$$\kappa = \frac{\lambda_{\max}}{\lambda_{\min}} = \frac{2.4288}{0.0011} = 2188.11$$

which also indicates strong multicollinearity. Only one condition index exceeds 1000, so we conclude that there is only one near-linear dependence in the data.

Eigensystem analysis can also be used to identify the nature of the near-linear dependences in data. The $\mathbf{X}'\mathbf{X}$ matrix may be decomposed as

$$\mathbf{X}'\mathbf{X} = \mathbf{T}\mathbf{\Lambda}\mathbf{T}'$$

where $\mathbf{\Lambda}$ is a $p \times p$ diagonal matrix whose main diagonal elements are the **eigenvalues** λ_j ($j = 1, 2, \dots, p$) of $\mathbf{X}'\mathbf{X}$ and \mathbf{T} is a $p \times p$ orthogonal matrix whose columns are the eigenvectors of $\mathbf{X}'\mathbf{X}$. Let the columns of \mathbf{T} be denoted by $\mathbf{t}_1, \mathbf{t}_2, \dots, \mathbf{t}_p$. If the eigenvalue λ_j is close to zero, indicating a near-linear dependence in the data, the elements of the associated eigenvector \mathbf{t}_j describe the nature of this linear dependence. Specifically the elements of the vector \mathbf{t}_j are the coefficients t_1, t_2, \dots, t_p in Eq. (9.1).

Table 9.6 displays the eigenvectors for the Webster, Gunst, and Mason data. The smallest eigenvalue is $\lambda_6 = 0.0011$, so the elements of the eigenvector \mathbf{t}_6 are the coefficients of the regressors in Eq. (9.1). This implies that

$$-0.44768x_1 - 0.42114x_2 - 0.54169x_3 - 0.57337x_4 - 0.00605x_5 - 0.00217x_6 = 0$$

Assuming that -0.00605 and -0.00217 are approximately zero and rearranging terms gives

$$x_1 \approx -0.941x_2 - 1.120x_3 - 1.281x_4$$

That is, the first four regressors add approximately to a constant. Thus, the elements of \mathbf{t}_6 directly reflect the relationship used to generate $x_1, x_2, x_3,$ and x_4 .

Belsley, Kuh, and Welsch [1980] propose a similar approach for diagnosing multicollinearity. The $n \times p$ \mathbf{X} matrix may be decomposed as

$$\mathbf{X} = \mathbf{U}\mathbf{D}\mathbf{T}'$$

where \mathbf{U} is $n \times p$, \mathbf{T} is $p \times p$, $\mathbf{U}'\mathbf{U} = \mathbf{I}$, $\mathbf{T}'\mathbf{T} = \mathbf{I}$, and \mathbf{D} is a $p \times p$ diagonal matrix with nonnegative diagonal elements $\mu_j, j = 1, 2, \dots, p$. The μ_j are called the **singular values** of \mathbf{X} and $\mathbf{X} = \mathbf{U}\mathbf{D}\mathbf{T}'$ is called the **singular-value decomposition** of \mathbf{X} . The singular-value decomposition is closely related to the concepts of eigenvalues and eigenvectors, since $\mathbf{X}'\mathbf{X} = (\mathbf{U}\mathbf{D}\mathbf{T}')'\mathbf{U}\mathbf{D}\mathbf{T}' = \mathbf{T}\mathbf{D}^2\mathbf{T}' = \mathbf{T}\mathbf{\Lambda}\mathbf{T}'$, so that the squares of the singular values of \mathbf{X} are the eigenvalues of $\mathbf{X}'\mathbf{X}$. Here \mathbf{T} is the matrix of eigenvectors of $\mathbf{X}'\mathbf{X}$

TABLE 9.6 Eigenvectors for the Webster, Gunst, and Mason Data

t_1	t_2	t_3	t_4	t_5	t_6
-.39072	-.33968	.67980	.07990	-.25104	-.44768
-.45560	-.05392	-.70013	.05769	-.34447	-.42114
.48264	-.45333	-.16078	.19103	.45364	-.54169
.18766	.73547	.13587	-.27645	.01521	-.57337
-.49773	-.09714	-.03185	-.56356	.65128	-.00605
.35195	-.35476	-.04864	-.74818	-.43375	-.00217

defined earlier, and \mathbf{U} is a matrix whose columns are the eigenvectors associated with the p nonzero eigenvalues of $\mathbf{X}\mathbf{X}'$.

Ill-conditioning in \mathbf{X} is reflected in the size of the singular values. There will be one small singular value for each near-linear dependence. The extent of ill-conditioning depends on how small the singular value is relative to the maximum singular value μ_{\max} . SAS follows Belsley, Kuh, and Welsch [1980] and defines the **condition indices** of the \mathbf{X} matrix as

$$\eta_j = \frac{\mu_{\max}}{\mu_j}, \quad j = 1, 2, \dots, p$$

The largest value for η_j is the condition number of \mathbf{X} . Note that this approach deals directly with the data matrix \mathbf{X} , with which we are principally concerned, not the matrix of sums of squares and cross products $\mathbf{X}'\mathbf{X}$. A further advantage of this approach is that algorithms for generating the singular-value decomposition are more stable numerically than those for eigensystem analysis, although in practice this is not likely to be a severe handicap if one prefers the eigensystem approach.

The covariance matrix of $\hat{\boldsymbol{\beta}}$ is

$$\text{Var}(\hat{\boldsymbol{\beta}}) = \sigma^2 (\mathbf{X}'\mathbf{X})^{-1} = \sigma^2 \mathbf{T}\mathbf{\Lambda}^{-1}\mathbf{T}'$$

and the variance of the j th regression coefficient is the j th diagonal element of this matrix, or

$$\text{Var}(\hat{\beta}_j) = \sigma^2 \sum_{i=1}^p \frac{t_{ji}^2}{\mu_i^2} = \sigma^2 \sum_{i=1}^p \frac{t_{ji}^2}{\lambda_i}$$

Note also that apart from σ^2 , the j th diagonal element of $\mathbf{T}\mathbf{\Lambda}^{-1}\mathbf{T}'$ is the j th VIF, so

$$\text{VIF}_j = \sum_{i=1}^p \frac{t_{ji}^2}{\mu_i^2} = \sum_{i=1}^p \frac{t_{ji}^2}{\lambda_i}$$

Clearly, one or more small singular values (or small eigenvalues) can dramatically inflate the variance of $\hat{\beta}_j$. Belsley, Kuh, and Welsch suggest using **variance decomposition proportions**, defined as

$$\pi_{ij} = \frac{t_{ji}^2 / \mu_i^2}{\text{VIF}_j}, \quad j = 1, 2, \dots, p$$

as measures of multicollinearity. If we array the π_{ij} in a $p \times p$ matrix π , then the elements of each column of π are just the proportions of the variance of each $\hat{\beta}_j$ (or each VIF) contributed by the i th singular value (or eigenvalue). If a high proportion of the variance for two or more regression coefficients is associated with one small singular value, multicollinearity is indicated. For example, if π_{32} and π_{34} are large, the third singular value is associated with a multicollinearity that is inflating the variances of $\hat{\beta}_2$ and $\hat{\beta}_4$. Condition indices greater than 30 and variance decomposition proportions greater than 0.5 are recommended guidelines.

TABLE 9.7 Variance Decomposition Proportions for the Webster, Gunst, and Mason [1974] Data

Number	Eigenvalue	Condition Indices	Variance Decomposition Proportions						
			X_1	X_2	X_3	X_4	X_5	X_6	
<i>A. Regressors Centered</i>									
1	2.42879	1.00000	0.0003	0.0005	0.0004	0.0000	0.0531	0.0350	
2	1.54615	1.25334	0.0004	0.0000	0.0005	0.0012	0.0032	0.0559	
3	0.92208	1.62297	0.0028	0.0033	0.0001	0.0001	0.0006	0.0018	
4	0.79398	1.74900	0.0000	0.0000	0.0002	0.0003	0.2083	0.04845	
5	0.30789	2.80864	0.0011	0.0024	0.0025	0.0000	0.7175	0.04199	
6	0.00111	46.86052	0.9953	0.9937	0.9964	0.9984	0.0172	0.0029	
<i>B. Regressors Not Centered</i>									
1	2.63287	1.00000	0.0001	0.0003	0.0003	0.0001	0.0001	0.0217	0.0043
2	1.82065	1.20255	0.0000	0.0001	0.0002	0.0005	0.0000	0.0523	0.0949
3	1.03335	159622	0.0000	0.0002	0.0000	0.0002	0.0013	0.0356	0.1010
4	0.65826	1.99994	0.0000	0.0005	0.0000	0.0005	0.0003	0.1906	0.3958
5	0.60573	2.08485	0.0000	0.0025	0.0035	0.0001	0.0001	0.0011	0.0002
6	0.24884	3.25280	0.0000	0.0012	0.0023	0.0028	0.0000	0.6909	0.4003
7	0.00031	92.25341	0.9999	0.9953	0.9936	0.9959	0.9983	0.0178	0.0034

Table 9.7 displays the condition indices of \mathbf{X} (η_j) and the variance-decomposition proportions (the π_{ij}) for the Webster, Gunst, and Mason data. In panel A of this table we have centered the regressors so that these variables are $(x_{ij} - \bar{x}_j)$, $j = 1, 2, \dots, 6$. In Section 9.4.2 we observed that the VIFs in a polynomial model are affected by centering the linear terms in the model before generating the higher order polynomial terms. Centering will also affect the variance decomposition proportions (and also the eigenvalues and eigenvectors). Essentially, centering removes any nonessential ill-conditioning resulting from the intercept.

Notice that there is only one large condition index ($\eta_6 = 46.86 > 30$), so there is one dependence in the columns of \mathbf{X} . Furthermore, the variance decomposition proportions π_{61} , π_{62} , π_{63} , and π_{64} all exceed 0.5, indicating that the first four regressors are involved in a multicollinear relationship. This is essentially the same information derived previously from examining the eigenvalues.

Belsley, Kuh, and Welsch [1980] suggest that the regressors should be scaled to unit length but not centered when computing the variance decomposition proportions so that the role of the intercept in near-linear dependences can be diagnosed. This option is displayed in panel B of Table 9.7. Note that the effect of this is to increase the spread in the eigenvalues and make the condition indices larger.

There is some controversy about whether regression data should be centered when diagnosing multicollinearity using either the eigensystem analysis or the variance decomposition proportion approach. Centering makes the intercept orthogonal to the other regressors, so we can view centering as an operation that removes ill-conditioning that is due to the model’s constant term. If the intercept has no physical interpretation (as is the case in many applications of regression in engineering and the physical sciences), then ill-conditioning caused by the constant term is truly “nonessential,” and thus centering the regressors is entirely appropriate.

However, if the intercept has interpretative value, then centering is not the best approach. Clearly the answer to this question is problem specific. For excellent discussions of this point, see Brown [1977] and Myers [1990].

9.4.4 Other Diagnostics

There are several other techniques that are occasionally useful in diagnosing multicollinearity. The **determinant** of $\mathbf{X}'\mathbf{X}$ can be used as an index of multicollinearity. Since the $\mathbf{X}'\mathbf{X}$ matrix is in correlation form, the possible range of values of the determinant is $0 \leq |\mathbf{X}'\mathbf{X}| \leq 1$. If $|\mathbf{X}'\mathbf{X}| = 1$, the regressors are orthogonal, while if $|\mathbf{X}'\mathbf{X}| = 0$, there is an exact linear dependence among the regressors. The degree of multicollinearity becomes more severe as $|\mathbf{X}'\mathbf{X}|$ approaches zero. While this measure of multicollinearity is easy to apply, it does not provide any information on the source of the multicollinearity.

Willan and Watts [1978] suggest another interpretation of this diagnostic. The joint $100(1 - \alpha)$ percent confidence region for $\boldsymbol{\beta}$ based on the observed data is

$$(\boldsymbol{\beta} - \hat{\boldsymbol{\beta}})' \mathbf{X}'\mathbf{X} (\boldsymbol{\beta} - \hat{\boldsymbol{\beta}}) \leq p \hat{\sigma}^2 F_{\alpha, p, n-p-1}$$

while the corresponding confidence region for $\hat{\boldsymbol{\beta}}$ based on the orthogonal reference design described earlier is

$$(\boldsymbol{\beta} - \hat{\boldsymbol{\beta}})' (\boldsymbol{\beta} - \hat{\boldsymbol{\beta}}) \leq p \hat{\sigma}^2 F_{\alpha, p, n-p-1}$$

The orthogonal reference design produces the smallest joint confidence region for fixed sample size and rms values and a given α . The ratio of the volumes of the two confidence regions is $|\mathbf{X}'\mathbf{X}|^{1/2}$, so that $|\mathbf{X}'\mathbf{X}|^{1/2}$ measures the loss of estimation power due to multicollinearity. Put another way, $100(|\mathbf{X}'\mathbf{X}|^{1/2} - 1)$ reflects the percentage increase in the volume of the joint confidence region for $\boldsymbol{\beta}$ because of the near-linear dependences in \mathbf{X} . For example, if $|\mathbf{X}'\mathbf{X}| = 0.25$, then the volume of the joint confidence region is $100[(0.25)^{-1/2} - 1] = 100\%$ larger than it would be if an orthogonal design had been used.

The F statistic for significance of regression and the individual t (or partial F) statistics can sometimes indicate the presence of multicollinearity. Specifically, if the overall F statistic is significant but the individual t statistics are all nonsignificant, multicollinearity is present. Unfortunately, many data sets that have significant multicollinearity will not exhibit this behavior, and so the usefulness of this measure of multicollinearity is questionable.

The **signs** and **magnitudes** of the regression coefficients will sometimes provide an indication that multicollinearity is present. In particular, if adding or removing a regressor produces large changes in the estimates of the regression coefficients, multicollinearity is indicated. If the deletion of one or more data points results in large changes in the regression coefficients, there may be multicollinearity present. Finally, if the signs or magnitudes of the regression coefficients in the regression model are contrary to prior expectation, we should be alert to possible multicollinearity. For example, the least-squares model for the acetylene data has large standardized regression coefficients for the $x_1 x_3$ interaction and for the squared terms x_1^2 and x_3^2 . It is somewhat unusual for quadratic models to display large regres-

sion coefficients for the higher order terms, and so this may be an indication of multicollinearity. However, one should be cautious in using the signs and magnitudes of the regression coefficients as indications of multicollinearity, as many seriously ill-conditioned data sets do not exhibit behavior that is obviously unusual in this respect.

We believe that the VIFs and the procedures based on the eigenvalues of $\mathbf{X}'\mathbf{X}$ are the best currently available multicollinearity diagnostics. They are easy to compute, straightforward to interpret, and useful in investigating the specific nature of the multicollinearity. For additional information on these and other methods of detecting multicollinearity, see Belsley, Kuh, and Welsch [1980], Farrar and Glauber [1997], and Willan and Watts [1978].

9.4.5 SAS and R Code for Generating Multicollinearity Diagnostics

The appropriate SAS code for generating the multicollinearity diagnostics for the acetylene data is

```
proc reg;
model conv = t h c t2 h2.c2 th tc hc / corrb vif collin;
```

The `corrb` option prints the variance–covariance matrix of the estimated coefficients in correlation form. The `vif` option prints the VIFs. The `collin` option prints the singular-value analysis including the condition numbers and the variance decomposition proportions. SAS uses the singular values to compute the condition numbers. Some other software packages use the eigenvalues, which are the squares of the singular values. The `collin` option includes the effect of the intercept on the diagnostics. The option `collinoint` performs the singular-value analysis excluding the intercept.

The collinearity diagnostics in R require the packages “`perturb`” and “`car`”. The R code to generate the collinearity diagnostics for the delivery data is:

```
deliver.model <- lm(time~cases+dist, data=deliver)
print(vif(deliver.model))
print(colldiag(deliver.model))
```

9.5 METHODS FOR DEALING WITH MULTICOLLINEARITY

Several techniques have been proposed for dealing with the problems caused by multicollinearity. The general approaches include collecting additional data, model respecification, and the use of estimation methods other than least squares that are specifically designed to combat the problems induced by multicollinearity.

9.5.1 Collecting Additional Data

Collecting additional data has been suggested as the best method of combating multicollinearity (e.g., see Farrar and Glauber [1967] and Silvey [1969]). The additional data should be collected in a manner designed to break up the multicollinearity in the existing data. For example, consider the delivery time data first introduced

Example 3.1. A plot of the regressor cases (x_1) versus distance (x_2) is shown in the matrix of scatterplots, Figure 3.4. We have remarked previously that most of these data lie along a line from low values of cases and distance to high values of cases and distance, and consequently there may be some problem with multicollinearity. This could be avoided by collecting some additional data at points designed to break up any potential multicollinearity, that is, at points where cases are small and distance is large and points where cases are large and distance is small.

Unfortunately, collecting additional data is not always possible because of **economic constraints** or because the process being studied is **no longer available** for sampling. Even when additional data are available it may be inappropriate to use if the new data extend the range of the regressor variables far beyond the analyst's region of interest. Furthermore, if the new data points are unusual or atypical of the process being studied, their presence in the sample could be highly influential on the fitted model. Finally, note that collecting additional data is not a viable solution to the multicollinearity problem when the multicollinearity is due to constraints on the model or in the population. For example, consider the factors family income (x_1) and house size (x_2) plotted in Figure 9.1. Collection of additional data would be of little value here, since the relationship between family income and house size is a structural characteristic of the population. Virtually all the data in the population will exhibit this behavior.

9.5.2 Model Respecification

Multicollinearity is often caused by the choice of model, such as when two highly correlated regressors are used in the regression equation. In these situations some **respecification** of the regression equation may lessen the impact of multicollinearity. One approach to model respecification is to redefine the regressors. For example, if x_1 , x_2 , and x_3 are nearly linearly dependent, it may be possible to find some function such as $x = (x_1 + x_2)/x_3$ or $x = x_1x_2x_3$ that preserves the information content in the original regressors but reduces the ill-conditioning.

Another widely used approach to model respecification is **variable elimination**. That is, if x_1 , x_2 and x_3 are nearly linearly dependent, eliminating one regressor (say x_3) may be helpful in combating multicollinearity. Variable elimination is often a highly effective technique. However, it may not provide a satisfactory solution if the regressors dropped from the model have significant explanatory power relative to the response y . That is, eliminating regressors to reduce multicollinearity may damage the predictive power of the model. Care must be exercised in variable selection because many of the selection procedures are seriously distorted by multicollinearity, and there is no assurance that the final model will exhibit any lesser degree of multicollinearity than was present in the original data. We discuss appropriate variable elimination techniques in Chapter 10.

9.5.3 Ridge Regression

When the method of least squares is applied to nonorthogonal data, very poor estimates of the regression coefficients can be obtained. We saw in Section 9.3 that the variance of the least-squares estimates of the regression coefficients may be considerably inflated, and the length of the vector of least-squares parameter

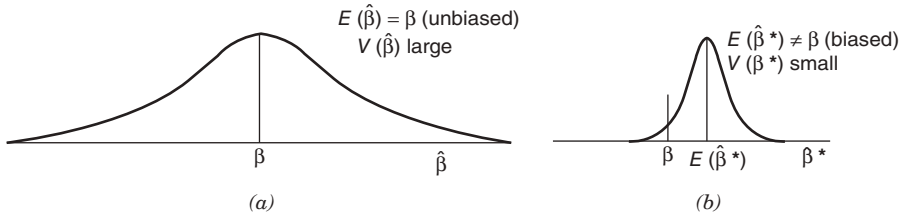

Figure 9.4 Sampling distribution of (a) unbiased and (b) biased estimators of β . (Adapted from Marquardt and Snee [1975], with permission of the publisher.)

estimates is too long on the average. This implies that the absolute value of the least-squares estimates are too large and that they are very unstable, that is, their magnitudes and signs may change considerably given a different sample.

The problem with the method of least squares is the requirement that $\hat{\beta}$ be an **unbiased estimator** of β . The Gauss-Markov property referred to in Section 3.2.3 assures us that the least-squares estimator has minimum variance in the class of unbiased linear estimators, but there is no guarantee that this variance will be small. The situation is illustrated in Figure 9.4a, where the sampling distribution of $\hat{\beta}$, the unbiased estimator of β , is shown. The variance of $\hat{\beta}$ is large, implying that confidence intervals on β would be wide and the point estimate $\hat{\beta}$ is very unstable.

One way to alleviate this problem is to drop the requirement that the estimator of β be unbiased. Suppose that we can find a **biased estimator** of β , say $\hat{\beta}^*$, that has a smaller variance than the unbiased estimator $\hat{\beta}$. The mean square error of the estimator $\hat{\beta}^*$ is defined as

$$\text{MSE}(\hat{\beta}^*) = E(\hat{\beta}^* - \beta)^2 = \text{Var}(\hat{\beta}^*) + [E(\hat{\beta}^*) - \beta]^2$$

or

$$\text{MSE}(\hat{\beta}^*) = \text{Var}(\hat{\beta}^*) + (\text{bias in } \hat{\beta}^*)^2$$

Note that the MSE is just the expected squared distance from $\hat{\beta}^*$ to β [see Eq. (9.4)]. By allowing a small amount of bias in $\hat{\beta}^*$, the variance of $\hat{\beta}^*$ can be made small such that the MSE of $\hat{\beta}^*$ is less than the variance of the unbiased estimator $\hat{\beta}$. Figure 9.4b illustrates a situation where the variance of the biased estimator is considerably smaller than the variance of the unbiased estimator (Figure 9.4a). Consequently, confidence intervals on β would be much narrower using the biased estimator. The small variance for the biased estimator also implies that $\hat{\beta}^*$ is a more stable estimator of β than is the unbiased estimator $\hat{\beta}$.

A number of procedures have been developed for obtaining biased estimators of regression coefficients. One of these procedures is **ridge regression**, originally proposed by Hoerl and Kennard [1970a, b]. The ridge estimator is found by solving a slightly modified version of the normal equations. Specifically we define the ridge estimator $\hat{\beta}_R$ as the solution to

$$(\mathbf{X}'\mathbf{X} + k\mathbf{I})\hat{\beta}_R = \mathbf{X}'\mathbf{y}$$

or

$$\hat{\beta}_R = (\mathbf{X}'\mathbf{X} + k\mathbf{I})^{-1} \mathbf{X}'\mathbf{y}$$

where $k \geq 0$ is a constant selected by the analyst. The procedure is called ridge regression because the underlying mathematics are similar to the method of ridge analysis used earlier by Hoerl [1959] for describing the behavior of second-order response surfaces. Note that when $k = 0$, the ridge estimator is the least-squares estimator.

The ridge estimator is a linear transformation of the least-squares estimator since

$$\hat{\beta}_R = (\mathbf{X}'\mathbf{X} + k\mathbf{I})^{-1} \mathbf{X}'\mathbf{y} = (\mathbf{X}'\mathbf{X} + k\mathbf{I})^{-1} (\mathbf{X}'\mathbf{X}) \hat{\beta} = \mathbf{Z}_k \hat{\beta}$$

Therefore, since $E(\hat{\beta}_R) = E(\mathbf{Z}_k \hat{\beta}) = \mathbf{Z}_k \beta$, $\hat{\beta}_R$ is a biased estimator of β . We usually refer to the constant k as the **biasing parameter**. The covariance matrix of $\hat{\beta}_R$ is

$$\text{Var}(\hat{\beta}_R) = \sigma^2 (\mathbf{X}'\mathbf{X} + k\mathbf{I})^{-1} \mathbf{X}'\mathbf{X} (\mathbf{X}'\mathbf{X} + k\mathbf{I})^{-1}$$

The mean square error of the ridge estimator is

$$\begin{aligned} \text{MSE}(\hat{\beta}_R) &= \text{Var}(\hat{\beta}_R) + (\text{bias in } \hat{\beta}_R)^2 \\ &= \sigma^2 \text{Tr}[(\mathbf{X}'\mathbf{X} + k\mathbf{I})^{-1} \mathbf{X}'\mathbf{X} (\mathbf{X}'\mathbf{X} + k\mathbf{I})^{-1}] + k^2 \beta' (\mathbf{X}'\mathbf{X} + k\mathbf{I})^{-2} \beta \\ &= \sigma^2 \sum_{j=1}^p \frac{\lambda_j}{(\lambda_j + k)^2} + k^2 \beta' (\mathbf{X}'\mathbf{X} + k\mathbf{I})^{-2} \beta \end{aligned}$$

where $\lambda_1, \lambda_2, \dots, \lambda_p$ are the eigenvalues of $\mathbf{X}'\mathbf{X}$. The first term on the right-hand side of this equation is the sum of variances of the parameters in $\hat{\beta}_R$ and the second term is the square of the bias. If $k > 0$, note that the bias in $\hat{\beta}_R$ increases with k . However, the variance decreases as k increases.

In using ridge regression we would like to choose a value of k such that the reduction in the variance term is greater than the increase in the squared bias. If this can be done, the mean square error of the ridge estimator $\hat{\beta}_R$ will be less than the variance of the least-squares estimator $\hat{\beta}$. Hoerl and Kennard proved that there exists a nonzero value of k for which the MSE of $\hat{\beta}_R$ is less than the variance of the least-squares estimator $\hat{\beta}$, provided that $\beta'\beta$ is bounded. The residual sum of squares is

$$\begin{aligned} SS_{\text{Res}} &= (\mathbf{y} - \mathbf{X}\hat{\beta}_R)' (\mathbf{y} - \mathbf{X}\hat{\beta}_R) \\ &= (\mathbf{y} - \mathbf{X}\hat{\beta})' (\mathbf{y} - \mathbf{X}\hat{\beta}) + (\hat{\beta}_R - \hat{\beta})' \mathbf{X}'\mathbf{X} (\hat{\beta}_R - \hat{\beta}) \end{aligned} \quad (9.7)$$

Since the first term on the right-hand side of Eq. (9.7) is the residual sum of squares for the least-squares estimates $\hat{\beta}$, we see that as k increases, the residual sum of squares increases. Consequently, because the total sum of squares is fixed, R^2 decreases as k increases. Therefore, the ridge estimate will not necessarily provide the best "fit" to the data, but this should not overly concern us, since we are more interested in obtaining a stable set of parameter estimates. The ridge estimates may

result in an equation that does a better job of predicting future observations than would least squares (although there is no conclusive **proof** that this will happen).

Hoed and Kennard have suggested that an appropriate value of k may be determined by inspection of the **ridge trace**. The ridge trace is a plot of the elements of $\hat{\beta}_R$ versus k for values of k usually in the interval 0–1. Marquardt and Snee [1975] suggest using up to about 25 values of k , spaced approximately logarithmically over the interval $[0, 1]$. If multicollinearity is severe, the instability in the regression coefficients will be obvious from the ridge trace. As k is increased, some of the ridge estimates will vary dramatically. At some value of k , the ridge estimates $\hat{\beta}_R$ will stabilize. The objective is to select a reasonably small value of k at which the ridge estimates $\hat{\beta}_R$ are stable. Hopefully this will produce a set of estimates with smaller MSE than the least-squares estimates.

Example 9.2 The Acetylene Data

To obtain the ridge solution for the acetylene data, we must solve the equations $(\mathbf{X}'\mathbf{X} + k\mathbf{I})\hat{\beta}_R = \mathbf{X}'\mathbf{y}$ for several values $0 \leq k \leq 1$, with $\mathbf{X}'\mathbf{X}$ and $\mathbf{X}'\mathbf{y}$ in correlation form. The ridge trace is shown in Figure 9.5, and the ridge coefficients for several values of k are listed in Table 9.8. This table also shows the residual mean square and R^2 for each ridge model. Notice that as k increases, MS_{Res} increases and R^2 decreases. The ridge trace illustrates the instability of the least-squares solution, as there are large changes in the regression coefficients for small values of k . However, the coefficients stabilize rapidly as k increases.

Judgment is required to interpret the ridge trace and select an appropriate value of k . We want to choose k large enough to provide stable coefficients, but not unnecessarily large ones, as this introduces additional bias and increases the residual mean square. From Figure 9.5 we see that reasonable coefficient stability is achieved in the region $0.008 < k < 0.064$ without a severe increase in the residual mean square (or loss in R^2). If we choose $k = 0.032$, the ridge regression model is

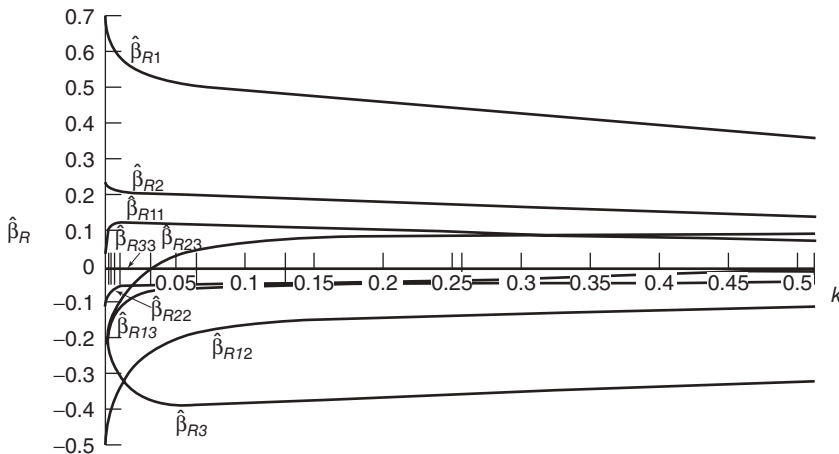

Figure 9.5 Ridge trace for acetylene data using nine regressors.

TABLE 9.8 Coefficients at Various Values of k

k	.000	.001	.002	.004	.008	.016	.032	.064	.128	.256	.512
$\beta_{R,1}$.3377	.6770	.6653	.6362	.6003	.5672	.5392	.5122	.4806	.4379	.3784
$\beta_{R,2}$.2337	.2242	.2222	.2199	.2173	.2148	.2117	.2066	.1971	.1807	.1554
$\beta_{R,3}$	-.6749	-.2129	-.2284	-.2671	-.3134	-.3515	-.3735	-.3800	-.3724	-.3500	-.3108
$\beta_{R,12}$	-.4799	-.4479	-.4258	-.3913	-.3437	-.2879	-.2329	-.1862	-.1508	-.1249	-.1044
$\beta_{R,13}$	-2.0344	-.2774	-.1887	-.1350	-.1017	-.0809	-.0675	-.0570	-.0454	-.0299	-.0092
$\beta_{R,23}$	-.2675	-.2173	-.1920	-.1535	-.1019	-.0433	.0123	.0562	.0849	.0985	.0991
$\beta_{R,11}$	-.8346	.0643	.1035	.1214	.1262	.1254	.1249	.1258	.1230	.1097	.0827
$\beta_{R,22}$	-.0904	-.0732	-.0682	-.0621	-.0558	-.0509	-.0481	-.0464	-.0444	-.0406	-.0341
$\beta_{R,33}$	-1.0015	-.2451	-.1853	-.1313	-.0825	-.0455	-.0267	-.0251	-.0339	-.0464	-.0586
MS_{Res}	.00038	.00047	.00049	.00054	.00062	.00074	.00094	.00127	.00206	.00425	.01002
R^2	.998	.997	.997	.997	.996	.996	.994	.992	.988	.975	.940

$$\hat{y} = 0.5392x_1 + 0.2117x_2 - 0.3735x_3 - 0.2329x_1x_2 - 0.0675x_1x_3 \\ + 0.0123x_2x_3 + 0.1249x_1^2 - 0.0481x_2^2 - 0.0267x_3^2$$

Note that in this model the estimates of β_{13} , β_{11} , and β_{23} are considerably smaller than the least-squares estimates and the original negative estimates of β_{23} and β_{11} are now positive. The ridge model expressed in terms of the original regressors is

$$\hat{P} = 0.7598 + 0.1392T + 0.0547H - 0.0965C - 0.0680TH - 0.0194TC \\ + 0.0039CH + 0.0407T^2 - 0.0112H^2 - 0.0067C^2$$

Figure 9.6 shows the performance of the ridge model in prediction for both interpolation (points *A, B, E, F, I,* and *J*) and extrapolation (points *C, D, G,* and *H*). Comparing Figures 9.6 and 9.3, we note that the ridge model predicts as well as the nine-term least-squares model at the boundary of the region covered by the data. However, the ridge model gives much more realistic predictions when extrapolating than does least squares. We conclude that ridge regression has produced a model that is superior to the original least squares fit.

The ridge regression estimates may be computed by using an ordinary least-squares computer program and augmenting the standardized data as follows:

$$\mathbf{X}_A = \begin{bmatrix} \mathbf{X} \\ \sqrt{k}\mathbf{I}_p \end{bmatrix}, \quad \mathbf{y}_A = \begin{bmatrix} \mathbf{y} \\ \mathbf{0}_p \end{bmatrix}$$

where $\sqrt{k}\mathbf{I}_p$ is a $p \times p$ diagonal matrix with diagonal elements equal to the square root of the biasing parameter and $\mathbf{0}_p$ is a $p \times 1$ vector of zeros. The ridge estimates are then computed from

$$\hat{\beta}_R = (\mathbf{X}'_A \mathbf{X}_A)^{-1} \mathbf{X}'_A \mathbf{y}_A = (\mathbf{X}'\mathbf{X} + k\mathbf{I}_p)^{-1} \mathbf{X}'\mathbf{y}$$

Table 9.9 shows the augmented matrix \mathbf{X}_A and vector \mathbf{y}_A required to produce the ridge solution for the acetylene data with $k = 0.032$. ■

Some Other Properties of Ridge Regression Figure 9.7 illustrates the geometry of ridge regression for a two-regressor problem. The point $\hat{\beta}$ at the center of the ellipses corresponds to the least-squares solution, where the residual sum of squares takes on its minimum value. The small ellipse represents the locus of points in the β_1, β_2 plane where the residual sum of squares is constant at some value greater than the minimum. The ridge estimate $\hat{\beta}_R$ is the shortest vector from the origin that produces a residual sum of squares equal to the value represented by the small ellipse. That is, the ridge estimate $\hat{\beta}_R$ produces the vector of regression coefficients with the smallest norm consistent with a specified increase in the residual sum of squares. We note that the ridge estimator shrinks the least-squares

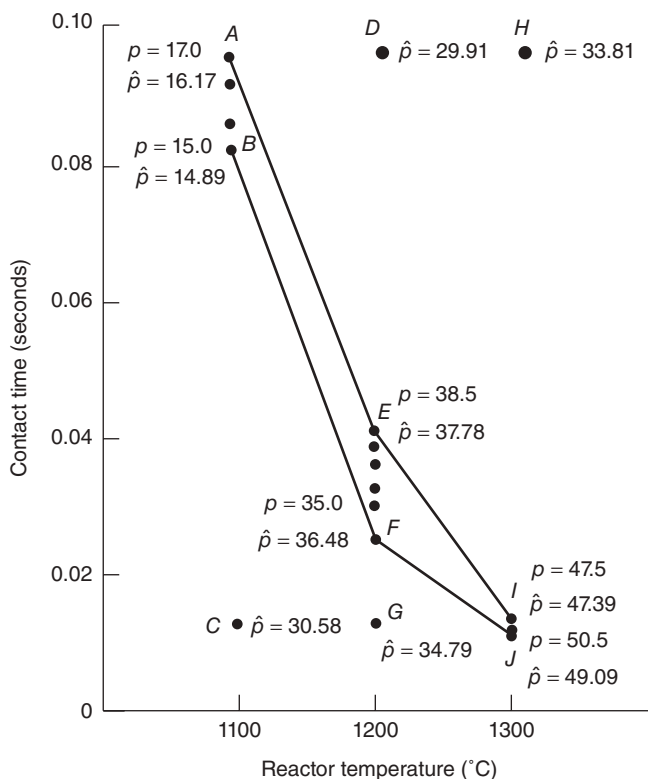

Figure 9.6 Performance of the ridge model with $k = 0.032$ in prediction and extrapolation for the acetylene data. (Adapted from Marquardt and Snee [1975], with permission of the publisher.)

estimator toward the origin. Consequently, ridge estimators (and other biased estimators generally) are sometimes called **shrinkage** estimators. Hocking [1976] has observed that the ridge estimator shrinks the least-squares estimator with respect to the contours of $\mathbf{X}'\mathbf{X}$. That is, $\hat{\boldsymbol{\beta}}_R$ is the solution to

$$\text{Minimize}_{\boldsymbol{\beta}} (\boldsymbol{\beta} - \hat{\boldsymbol{\beta}})' \mathbf{X}'\mathbf{X} (\boldsymbol{\beta} - \hat{\boldsymbol{\beta}})$$

subject to $\boldsymbol{\beta}'\boldsymbol{\beta} \leq d^2$

where the radius d depends on k .

Many of the properties of the ridge estimator assume that the value of k is fixed. In practice, since k is estimated from the data by inspection of the ridge trace, k is **stochastic**. It is of interest to ask if the optimality properties cited by Hoerl and Kennard hold if k is stochastic. Several authors have shown through simulations that ridge regression generally offers improvement in mean square error over least squares when k is estimated from the data. Theobald [1974] has generalized the

TABLE 9.9 Augmented Matrix X_A and Vector y_A for Generating the Ridge Solution for the Acetylene Data with $k = 0.032$

.280224	-.22544	-.23106	-.33766	-.02085	309525	.078278	-.04116	-.03452	.27979
.280224	-.15704	-.23106	-.25371	-.02085	.236588	.078278	-.1327	-.03452	.305829
.280224	-.06584	-.23514	-.14179	-.02579	.140577	.078278	-.20378	-.02735	.312339
.280224	.048167	-.2229	-.00189	-.01098	.0196	.078278	-.2107	-.04847	.26894
.280224	.207774	-.21882	.193976	-.00605	-.14065	.078278	-.06745	-.05526	.24724
.280224	.481385	-.23106	.529744	-.02085	-.44415	.078278	.593235	-.03452	.182141
-.04003	-.32577	-.00255	-.00413	.258949	.073001	-.29746	.152387	-.23548	-.1759
-.04003	-.22544	-.01887	-.02171	.261769	.088842	-.29746	-.04116	-.23418	-.09995
-.04003	-.06584	-.06784	-.0497	-.270231	.089856	-.29746	-.20378	-.21822	-.03486
-.04003	.048167	-.1168	-.06968	.278693	.043276	-.29746	-.2107	-.18419	-.02401
-.04003	.207774	-.05152	-.09766	.267411	.019961	-.29746	-.06745	-.22554	.041094
-.04003	.481385	.005609	-.14563	.257539	.0832021	-.29746	.593235	-.23538	.051944
-.36029	-.32577	.356528	.452517	-.29615	-.46678	.328768	.152387	.243742	$y_A =$
-.36029	-.22544	.470781	.294227	-.47384	-.42042	.328768	-.04116	.599999	-.04146
-.36029	-.06584	.421815	.042401	-.39769	-.05859	.328768	-.20378	.435271	-.33865
-.36029	.207774	.37285	-.3893	-.32153	.427375	.328768	-.06745	.288613	-.14335
.17888	0	0	0	0	0	0	0	0	0
0	.17888	0	0	0	0	0	0	0	0
0	0	.17888	0	0	0	0	0	0	0
0	0	0	.17888	0	0	0	0	0	0
0	0	0	0	.17888	0	0	0	0	0
0	0	0	0	0	.17888	0	0	0	0
0	0	0	0	0	0	.17888	0	0	0
0	0	0	0	0	0	0	.17888	0	0
0	0	0	0	0	0	0	0	.17888	0
0	0	0	0	0	0	0	0	0	.17888

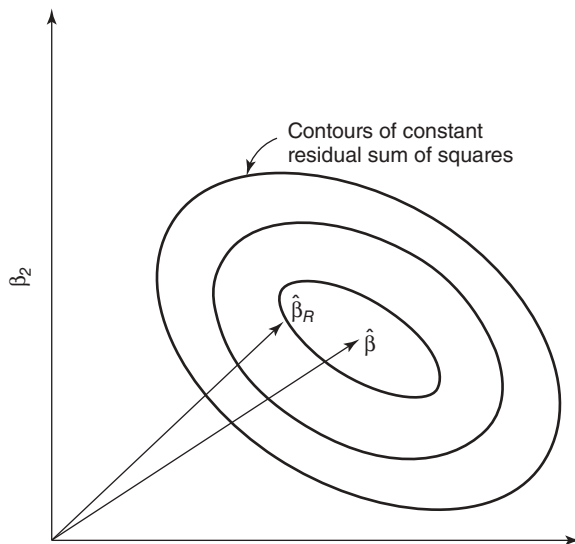

Figure 9.7 A geometrical interpretation of ridge regression.

conditions under which ridge regression leads to smaller MSE than least squares. The expected improvement depends on the orientation of the β vector relative to the eigenvectors of $\mathbf{X}'\mathbf{X}$. The expected improvement is greatest when β coincides with the eigenvector associated with the largest eigenvalue of $\mathbf{X}'\mathbf{X}$. Other interesting results appear in Lowerre [1974] and Mayer and Willke [1973].

Obenchain [1977] has shown that nonstochastically shrunk ridge estimators yield the same t and F statistics for testing hypotheses as does least squares. Thus, although ridge regression leads to biased point estimates, it does not generally require a new distribution theory. However, distributional properties are still unknown for stochastic choices of k . One would assume that when k is small, the usual normal-theory inference would be approximately applicable.

Relationship to Other Estimators Ridge regression is closely related to **Bayesian Estimation**. Generally, if prior information about β can be described by a p -variate normal distribution with mean vector β_0 and covariance matrix \mathbf{V}_0 , then the Bayes estimator of β is

$$\hat{\beta}_B = \left(\frac{1}{\sigma^2} \mathbf{X}'\mathbf{X} + \mathbf{V}_0^{-1} \right)^{-1} \left(\frac{1}{\sigma^2} \mathbf{X}'\mathbf{y} + \mathbf{V}_0^{-1} \beta_0 \right)$$

The use of Bayesian methods in regression is discussed in Leamer [1973, 1978] and Zellner [1971]. Two major drawbacks of this approach are that the data analyst must make an explicit statement about the form of the prior distribution and the statistical theory is not widely understood. However, if we choose the prior mean $\beta_0 = \mathbf{0}$ and $\mathbf{V}_0 = \sigma_0^2 \mathbf{I}$, then we obtain

$$\hat{\beta}_B + (\mathbf{X}'\mathbf{X} + k\mathbf{I})^{-1} \mathbf{X}'\mathbf{y} \equiv \hat{\beta}_R, \quad 2k = \frac{\sigma^2}{\sigma_0^2}$$

the usual ridge estimator. In effect, the method of least squares can be viewed as a Bayes estimator using an unbounded uniform prior distribution for β . The ridge estimator results from a prior distribution that places weak boundedness conditions on β . Also see Lindley and Smith [1972].

Methods for Choosing k Much of the controversy concerning ridge regression centers around the choice of the biasing parameter k . Choosing k by inspection of the ridge trace is a subjective procedure requiring judgment on the part of the analyst. Several authors have proposed procedures for choosing k that are more analytical. Hoerl, Kennard, and Baldwin [1975] have suggested that an appropriate choice for k is

$$k = \frac{p\hat{\sigma}^2}{\hat{\beta}'\hat{\beta}} \quad (9.8)$$

where $\hat{\beta}$ and $\hat{\sigma}^2$ are found from the least-squares solution. They showed via simulation that the resulting ridge estimator had significant improvement in MSE over least squares. In a subsequent paper, Hoerl and Kennard [1976] proposed an iterative estimation procedure based on Eq. (11.8). McDonald and Galarneau [1975] suggest choosing k so that

$$\hat{\beta}'_R \hat{\beta}_R = \hat{\beta}'\hat{\beta} - \sigma^2 \sum_{j=1}^p \left(\frac{1}{\lambda_j} \right)$$

A drawback to this procedure is that k may be negative, Mallows [1973] suggested a graphical procedure for selecting k based on a modification of his C_p statistic. Another approach chooses k to minimize a modification of the PRESS statistic. Wahba, Golub, and Health [1979] suggest choosing k to minimize a cross-validation statistic.

There are many other possibilities for choosing k . For example, Marquardt [1970] has proposed using a value of k such that the maximum VIP is between 1 and 10, preferably closer to 1. Other methods of choosing k have been suggested by Dempster, Schatzoff, and Wermuth [1971], Goldstein and Smith [1974], Lawless and Wang [1976], Lindley and Smith [1972], and Obenchain [1975]. Hoerl and Kennard [1970a] proposed an extension of standard ridge regression that allows separate k 's for each regression. This is called **generalized ridge regression**. There is no guarantee that these methods are superior to straightforward inspection of the ridge trace.

9.5.4 Principal-Component Regression

Biased estimators of regression coefficients can also be obtained by using a procedure known as **principal-component regression**. Consider the canonical form of the model,

$$\mathbf{y} = \mathbf{Z}\boldsymbol{\alpha} + \boldsymbol{\varepsilon}$$

where

$$\mathbf{Z} = \mathbf{X}\mathbf{T}, \quad \boldsymbol{\alpha} = \mathbf{T}'\boldsymbol{\beta}, \quad \mathbf{T}'\mathbf{X}'\mathbf{X}\mathbf{T} = \mathbf{Z}'\mathbf{Z} = \boldsymbol{\Lambda}$$

Recall that $\boldsymbol{\Lambda} = \text{diag}(\lambda_1, \lambda_2, \dots, \lambda_p)$ is a $p \times p$ diagonal matrix of the eigenvalues of $\mathbf{X}'\mathbf{X}$ and \mathbf{T} is a $p \times p$ orthogonal matrix whose columns are the eigenvectors associated with $\lambda_1, \lambda_2, \dots, \lambda_p$. The columns of \mathbf{Z} , which define a new set of orthogonal regressors, such as

$$\mathbf{Z} = [\mathbf{Z}_1, \mathbf{Z}_2, \dots, \mathbf{Z}_p]$$

are referred to as **principal components**.

The least-squares estimator of $\hat{\boldsymbol{\alpha}}$ is

$$\hat{\boldsymbol{\alpha}} = (\mathbf{Z}'\mathbf{Z})^{-1}\mathbf{Z}'\mathbf{y} = \boldsymbol{\Lambda}^{-1}\mathbf{Z}'\mathbf{y}$$

and the covariance matrix of $\hat{\boldsymbol{\alpha}}$ is

$$\text{Var}(\hat{\boldsymbol{\alpha}}) = \sigma^2(\mathbf{Z}'\mathbf{Z})^{-1} = \sigma^2\boldsymbol{\Lambda}^{-1}$$

Thus, a small eigenvalue of $\mathbf{X}'\mathbf{X}$ means that the variance of the corresponding orthogonal regression coefficient will be large. Since

$$\mathbf{Z}'\mathbf{Z} = \sum_{i=1}^p \sum_{j=1}^p \mathbf{Z}_i\mathbf{Z}_j' = \boldsymbol{\Lambda}$$

we often refer to the eigenvalue λ_j as the variance of the j th principal component. If all the λ_j are equal to unity, the **original** regressors are orthogonal, while if a λ_j is exactly equal to zero, this implies a perfect linear relationship between the **original** regressors. One or more of the λ_j near zero implies that multicollinearity is present. Note also that the covariance matrix of the standardized regression coefficients $\hat{\boldsymbol{\beta}}$ is

$$\text{Var}(\hat{\boldsymbol{\beta}}) = \text{Var}(\mathbf{T}\hat{\boldsymbol{\alpha}}) = \mathbf{T}\boldsymbol{\Lambda}^{-1}\mathbf{T}'\sigma^2$$

This implies that the variance of $\hat{\beta}_j$ is $\hat{\sigma}^2(\sum_{j=1}^p t_{ji}^2/\lambda_i)$. Therefore, the variance of $\hat{\beta}_j$ is a linear combination of the reciprocals of the eigenvalues. This demonstrates how one or more small eigenvalues can destroy the precision of the least-squares estimate $\hat{\beta}_j$.

We have observed previously how the eigenvalues and eigenvectors of $\mathbf{X}'\mathbf{X}$ provide specific information on the nature of the multicollinearity. Since $\mathbf{Z} = \mathbf{X}\mathbf{T}$, we have

$$\mathbf{Z}_i = \sum_{j=1}^p t_{ji}\mathbf{X}_j \quad (9.9)$$

where \mathbf{X}_j is the j th column of the \mathbf{X} matrix and t_{ji} are the elements of the i th column of \mathbf{T} (the i th eigenvector of $\mathbf{X}'\mathbf{X}$). If the variance of the i th principal

component (λ_j) is small, this implies that \mathbf{Z}_i is nearly constant, and Eq. (9.9) indicates that there is a linear combination of the **original regressors** that is nearly constant. This is the definition of multicollinearity, that is, the t_{ji} are the constants in Eq. (9.1). Therefore, Eq. (9.9) explains why the elements of the eigenvector associated with a small eigenvalue of $\mathbf{X}'\mathbf{X}$ identify the regressors involved in the multicollinearity.

The principal-component regression approach combats multicollinearity by using less than the full set of principal components in the model. To obtain the principal-component estimator, assume that the regressors are arranged in order of decreasing eigenvalues, $\lambda_1 \geq \lambda_2 \geq \dots \geq \lambda_p > 0$. Suppose that the last s of these eigenvalues are approximately equal to zero. In principal-component regression the principal components corresponding to near-zero eigenvalues are removed from the analysis and least squares applied to the remaining components. That is,

$$\hat{\boldsymbol{\alpha}}_{\text{PC}} = \mathbf{B}\hat{\boldsymbol{\alpha}}$$

where $b_1 = b_2 = \dots = b_{p-s} = 1$ and $b_{p-s+1} = b_{p-s+2} = \dots = b_p = 0$. Thus, the principal-component estimator is

$$\hat{\boldsymbol{\alpha}}_{\text{PC}} = \begin{bmatrix} \hat{\boldsymbol{\alpha}}_1 \\ \hat{\boldsymbol{\alpha}}_2 \\ \vdots \\ \hat{\boldsymbol{\alpha}}_{p-s} \\ \hline 0 \\ 0 \\ \vdots \\ 0 \end{bmatrix} \begin{matrix} p-s \text{ components} \\ s \text{ components} \end{matrix}$$

or in terms of the standardized regressors

$$\hat{\boldsymbol{\beta}}_{\text{PC}} = \mathbf{T}\hat{\boldsymbol{\alpha}}_{\text{PC}} = \sum_{j=1}^{p-s} \lambda_j^{-1} \mathbf{t}_j' \mathbf{X}' \mathbf{y} \mathbf{t}_j \tag{9.10}$$

A simulation study by Gunst and Mason [1977] showed that principal-component regression offers considerable improvement over least squares when the data are ill-conditioned. They also point out that another advantage of principal components is that exact distribution theory and variable selection procedures are available (see Mansfield, Webster, and Gunst [1977]). Some computer packages will perform principal-component regression.

Example 9.3 Principal-Component Regression for the Acetylene Data

We illustrate the use of principal-component regression for the acetylene data. We begin with the linear transformation $\mathbf{Z} = \mathbf{X}\mathbf{T}$ that transforms the original standardized regressors into an orthogonal set of variables (the principal components). The

TABLE 9.10 Matrix T of Eigenvectors and Eigenvalues λ_j for the Acetylene Data

Eigenvectors									Eigenvalues λ_j
.3387	.1057	.6495	.0073	.1428	-.2488	-.2077	-.5436	.1768	4.20480
.1324	.3391	-.0068	-.7243	-.5843	.0205	-.0102	-.0295	-.0035	2.16261
-.4137	-.0978	-.4696	-.0718	-.0182	.0160	-.1468	-.7172	.2390	1.13839
-.2191	.5403	.0897	.3612	-.1661	.3733	-.5885	.0909	.0003	1.04130
.4493	.0860	-.2863	.1912	-.0943	.0333	.0575	.1543	.7969	0.38453
.2524	-.5172	-.0570	-.3447	.2007	.3232	-.6209	.1280	.0061	0.04951
-.4056	-.0742	.4404	-.2230	.1443	.5393	.3233	.0565	.4087	0.01363
.0258	.5316	-.2240	-.3417	.7342	-.0705	-.0057	.0761	.0050	0.00513
-.4667	-.0969	.1421	-.1337	-.0350	-.6299	-.3089	.3631	.3309	0.00010

eigenvalues λ_j and the \mathbf{T} matrix for the acetylene data are shown in Table 9.10. This matrix indicates that the relationship between z_1 (for example) and the standardized regressors is

$$z_1 = 0.3387x_1 + 0.1324x_2 - 0.4137x_3 - 0.2191x_1x_2 + 0.4493x_1x_3 \\ + 0.2524x_2x_3 - 0.4056x_1^2 + 0.0258x_2^2 - 0.4667x_3^2$$

The relationships between the remaining principal components z_2, z_3, \dots, z_9 and the standardized regressors are determined similarly. Table 9.11 shows the elements of the \mathbf{Z} matrix (sometimes called the principal-component scores).

The principal-component estimator reduces the effects of multicollinearity by using a subset of the principal components in the model. Since there are four small eigenvalues for the acetylene data, this implies that there are four principal components that should be deleted. We will exclude $z_6, z_7, z_8,$ and z_9 and consider regressions involving only the first five principal components.

Suppose we consider a regression model involving only the first principal component, as in

$$y = \alpha_1 z_1 + \varepsilon$$

The fitted model is

$$\hat{y} = -0.35225z_1$$

or $\hat{\alpha}'_{PC} = [-0.35225, 0, 0, 0, 0, 0, 0, 0, 0]$. The coefficients in terms of the standardized regressors are found from $\hat{\beta}'_{PC} = \mathbf{T}\hat{\alpha}'_{PC}$. Panel A of Table 9.11 shows the resulting standardized regression coefficients as well as the regression coefficients in terms of the original centered regressors. Note that even though only one principal component is included, the model produces estimates for all nine standardized regression coefficients.

The results of adding the other principal components $z_2, z_3, z_4,$ and z_5 to the model one at a time are displayed in panels B, C, D, and E, respectively, of Table 9.12. We see that using different numbers of principal components in the model produces

TABLE 9.11 Matrix $Z = XT$ for the Acetylene Data

Observation	Z_1	Z_2	Z_3	$Z_4 (= Z_{x_1x_2})$	$Z_5 (= Z_{x_1x_3})$	$Z_6 (= Z_{x_2x_3})$	$Z_7 (= Z_{x_1^2})$	$Z_8 (= Z_{x_2^2})$	$Z_9 (= Z_{x_3^2})$
1	.5415	-1.0347	1.0487	-1.880	1.7389	-.6593	.6492	.7822	.2402
2	.4846	-.8830	1.1638	-.0468	.8909	-.3874	.5067	.2045	-.1939
3	.4046	-.6129	.2914	.0676	-.0025	-.1631	.2187	-.0898	-1.6609
4	.3388	-.1513	3.3176	.1315	-.7526	.3579	.1269	-1.2150	.9250
5	.2353	.6905	1.2785	-.0089	-1.0842	.6884	-.4181	-1.2768	1.6754
6	.0310	2.7455	.9535	-.7783	.2235	.2093	-1.1200	1.3128	-1.1453
7	.5940	-.0165	-1.0885	1.1554	1.5790	.1926	-1.3363	-.4626	.5964
8	.6385	-.2399	-.9170	1.0916	.3634	.4238	-1.2453	-.7138	-.3611
9	.7139	-.3558	-.7151	.8354	-.9374	.3207	-.6525	.5144	-.7716
10	.7436	-.2228	-.6170	.5668	-1.4297	-.4038	.5657	2.5203	1.4085
11	.7668	.1034	-.8626	-.0706	-1.3472	-.3706	1.5958	-.8815	-1.3485
12	.8726	1.1054	-1.5272	-1.8442	.8129	-.9285	.8411	-.8981	.7053
13	-1.7109	.8164	-.3702	1.2052	.8885	1.9123	2.0708	.2251	-1.1036
14	-2.1618	.1860	-.1026	.5619	-1.1290	-2.5588	-.3380	-1.080	.8652
15	-1.6050	-.6784	-.2117	-.3325	-.7456	-.0658	-.8259	-.4662	-1.0012
16	-.8875	-1.4521	-.6417	-2.3461	-.0690	1.4324	-.6387	.5524	.1699

TABLE 9.12 Principal Components Regression for the Acetylene Data

Parameter	Principal Components in Model														
	A			B			C			D			E		
	z_1	z_1, z_2		z_1, z_2, z_3		z_1, z_2, z_3, z_4		z_1, z_2, z_3, z_4, z_5							
Standardized Estimate	Original Estimate	Standardized Estimate	Original Estimate	Standardized Estimate	Original Estimate	Standardized Estimate	Original Estimate	Standardized Estimate	Original Estimate	Standardized Estimate	Original Estimate	Standardized Estimate	Original Estimate		
β_0	.0000	42.1943	.0000	42.2219	.0000	36.6275	.0000	34.6688	.0000	34.6688	.0000	34.7517			
β_1	.1193	1.4194	.1188	1.4141	.5087	6.0508	.5070	6.0324	.5056	6.0139	.5056	6.0139			
β_2	.0466	.5530	.0450	.5346	.0409	.4885	.2139	2.5438	.2195	2.6129	.2195	2.6129			
β_3	-.1457	-1.7327	-.1453	-1.7281	-.4272	-5.0830	-.4100	-4.8803	-.4099	4.8757	-.4099	4.8757			
β_{12}	-.0772	-1.0369	-.0798	-1.0738	-.0260	-.3502	-.1123	-1.5115	-.1107	-1.4885	-.1107	-1.4885			
β_{13}	.1583	2.0968	.1578	2.0922	-.0143	-1.843	-.0597	-7.926	-.0588	-7.788	-.0588	-7.788			
β_{23}	.0889	1.2627	.0914	1.2950	.0572	.8111	.1396	1.9816	.1377	1.9493	.1377	1.9493			
β_{11}	-.1429	-2.1429	-.1425	-2.1383	.1219	1.8295	.1751	2.6268	.1738	2.6083	.1738	2.6083			
β_{22}	.0091	.0968	.0065	.0691	-.1280	-1.3779	-.0460	-4.977	-.0533	-5.760	-.0533	-5.760			
β_{33}	-.1644	-1.9033	-.1639	-1.8986	-.0786	-.9125	-.0467	-5.392	-.0463	-5.346	-.0463	-5.346			
R^2	.5217		.5218		.9320		.9914		.9915		.9915				
MS_{Res}	.079713		.079705		.011333		.001427		.00142		.00142				

substantially different estimates of the regression coefficients. Furthermore, the principal-component estimates differ considerably from the least-squares estimates (e.g., see Table 9.8). However, the principal-component procedure with either four or five components included results in coefficient estimates that do not differ dramatically from those produced by the other biased estimation methods (refer to the ordinary ridge regression estimates in Table 9.9). Principal-component analysis shrinks the large least-squares estimates of β_{13} and β_{33} and changes the sign of the original negative least-squares estimate of β_{11} . The five-component model does not substantially degrade the fit to the original data as there has been little loss in R^2 from the least-squares model. Thus, we conclude that the relationship based on the first five principal components provides a more plausible model for the acetylene data than was obtained via ordinary least squares.

Marquardt [1970] suggested a generalization of principal-component regression. He felt that the assumption of an integral rank for the \mathbf{X} matrix is too restrictive and proposed a “fractional rank” estimator that allows the rank to be a piecewise continuous function.

Hawkins [1973] and Webster et al. [1974] developed latent root procedures following the same philosophy as principal components. Gunst, Webster, and Mason [1976] and Gunst and Masou [1977] indicate that latent root regression may provide considerable improvement in mean square error over least squares. Gunst [1979] points out that latent root regression can produce regression coefficients that are very similar to those found by principal components, particularly when there are only one or two strong multicollinearities in \mathbf{X} . A number of large-sample properties of latent root regression are in White and Gunst [1979]. ■

9.5.5 Comparison and Evaluation of Biased Estimators

A number of Monte Carlo simulation studies have been conducted to examine the effectiveness of biased estimators and to attempt to determine which procedures perform best. For example, see McDonald and Galarneau [1975], Hoerl and Kennard [1976], Hoerl, Kennard, and Baldwin [1975] (who compare least squares and ridge), Gunst et al. [1976] (latent root versus least squares), Lawless [1978], Hemmerle and Brantle [1978] (ridge, generalized ridge, and least squares), Lawless and Wang [1976] (least squares, ridge, and principal components), Wichern and Churchill [1978], Gibbons [1979] (various forms of ridge), Gunst and Mason [1977] (ridge, principal components, latent root, and others), and Dempster et al. [1977]. The Dempster et al. [1977] study compared 57 different estimators for 160 different model configurations. While no single procedure emerges from these studies as best overall, there is considerable evidence indicating the superiority of biased estimation to least squares if multicollinearity is present. Our own preference in practice is for ordinary ridge regression with k selected by inspection of the ridge trace. The procedure is straightforward and easy to implement on a standard least-squares computer program, and the analyst can learn to interpret the ridge trace very quickly. It is also occasionally useful to find the “optimum” value of k suggested by Hoerl, Kennard, and Baldwin [1975] and the iteratively estimated “optimum” k of Hoed and Kennard [1976] and compare the resulting models with the one obtained via the ridge trace.

The use of biased estimators in regression is not without controversy. Several authors have been critical of ridge regression and other related biased estimation techniques. Conniffe and Stone [1973, 1975] have criticized the use of the ridge trace to select the biasing parameter, since $\hat{\beta}_R$ will change slowly and eventually stabilize as k increases even for orthogonal regressors. They also claim that if the data are not adequate to support a least-squares analysis, then it is unlikely that ridge regression will be of any substantive help, since the parameter estimates will be nonsensical. Marquardt and Snee [1975] and Smith and Goldstein [1975] do not accept these conclusions and feel that biased estimators are a valuable tool for the data analyst confronted by ill-conditioned data. Several authors have noted that while we can prove that there exists a k such that the mean square error of the ridge estimator is always less than the mean square error of the least-squares estimator, there is no assurance that the ridge trace (or any other method that selects the biasing parameter stochastically by analysis of the data) produces the optimal k .

Draper and Van Nostrand [1977a, b, 1979] are also critical of biased estimators. They find fault with a number of the technical details of the simulation studies used as the basis of claims of improvement in MSE for biased estimation, suggesting that the simulations have been designed to favor the biased estimators. They note that ridge regression is really only appropriate in situations where external information is added to a least-squares problem. This may take the form of either the Bayesian formulation and interpretation of the procedure or a constrained least-squares problem in which the constraints on β are chosen to reflect the analyst's knowledge of the regression coefficients to "improve the conditioning" of the data.

Smith and Campbell [1980] suggest using explicit Bayesian analysis or mixed estimation to resolve multicollinearity problems. They reject ridge methods as weak and imprecise because they only loosely incorporate prior beliefs and information into the analysis. When explicit prior information is known, then Bayesian or mixed estimation should certainly be used. However, often the prior information is not easily reduced to a specific prior distribution, and ridge regression methods offer a method to incorporate, at least approximately, this knowledge.

There has also been some controversy surrounding whether the regressors and the response should be centered and scaled so that $\mathbf{X}'\mathbf{X}$ and $\mathbf{X}'\mathbf{y}$ are in correlation form. This results in an artificial removal of the intercept from the model. Effectively the intercept in the ridge model is estimated by \bar{y} . Hoerl and Kennard [1970a, b] use this approach, as do Marquardt and Snee [1975], who note that centering tends to minimize any nonessential ill-conditioning when fitting polynomials. On the other hand, Brown [1977] feels that the variables should not be centered, as centering affects only the intercept estimate and not the slopes. Belsley, Kuh, and Welsch [1980] suggest not centering the regressors so that the role of the intercept in any near-linear dependences may be diagnosed. Centering and scaling allow the analyst to think of the parameter estimates as standardized regression coefficients, which is often intuitively appealing. Furthermore, centering the regressors can remove nonessential ill-conditioning, thereby reducing variance inflation in the parameter estimates. Consequently, we recommend both centering and scaling the data.

Despite the objections noted, we believe that biased estimation methods are useful techniques that the analyst should consider when dealing with multicollinearity. Biased estimation methods certainly compare very favorably to other methods

for handling multicollinearity, such as variable elimination. As Marquardt and Snee [1975] note, it is often better to use some of the information in all of the regressors, as ridge regression does, than to use all of the information in some regressors and none of the information in others, as variable elimination does. Furthermore, variable elimination can be thought of as a form of biased estimation because subset regression models often produce biased estimates of the regression coefficients. In effect, variable elimination often shrinks the vector of parameter estimates, as does ridge regression. We do not recommend the mechanical or automatic use of ridge regression without thoughtful study of the data and careful analysis of the adequacy of the final model. Properly used, biased estimation methods are a valuable tool in the data analyst's kit.

9.6 USING SAS TO PERFORM RIDGE AND PRINCIPAL-COMPONENT REGRESSION

Table 9.14 gives the SAS code to perform ridge regression for the acetylene data. The lines immediately prior to the cards statement center and scale the linear terms. The other statements create the interaction and pure quadratic terms. The option

```
ridge = 0.006 to 0.04 by .002
```

on the first proc reg statement creates the series of k 's to be used for the ridge trace. Typically, we would start the range of values for k at 0, which would yield the ordinary least-squares (OLS) estimates. Unfortunately, for the acetylene data the OLS estimates greatly distort the ridge trace plot to the point that it is very difficult to select a good choice for k . The statement

```
plot / ridgeplot nomodel;
```

creates the actual ridge trace. The option

```
ridge = .032
```

on the second proc reg statement fixes the value of k to 0.032.

Table 9.15 gives the additional SAS code to perform principal-component regression. The statement

```
proc princomp data=acetylene out=pc_acetylene std,
```

sets up the principal-component analysis and creates an output data set called

```
pc_acetylene.
```

The std option standardizes the principal-component scores to unit variance. The statement

TABLE 9.14 SAS Code to Perform Ridge Regression for Acetylene Data

```

data acetylene;
input conv t h c;
t =(t - 1212.5) / 80.623;
h =(h - 12.44) / 5.662;
c =(c - 0.0403) / 0.03164;
th = t*h;
tc = t*c;
hc = h*c;
t2 = t*t;
h2 = h*h;
c2 = c*c;
cards;
49.0 1300 7.5 0.0120
50.2 1300 9.0 0.0120
50.5 1300 11.0 0.0115
48.5 1300 13.5 0.0130
47.5 1300 17.0 0.0135
44.5 1300 23.0 0.0120
28.0 1200 5.3 0.0400
31.5 1200 7.5 0.0380
34.5 1200 11.0 0.0320
35.0 1200 13.5 0.0260
38.0 1200 17.0 0.0340
38.5 1200 23.0 0.0410
15.0 1100 5.3 0.0840
17.0 1100 7.5 0.0980
20.5 1100 11.0 0.0920
29.5 1100 17.0 0.0860
proc reg outest = b ridge = 0.006 to 0.04 by .002;
model conv = t h c t2 h2 c2 th tc hc / noprint;
plot / ridgeplot nomodel;
run;
proc reg outest = b2 data = acetylene ridge =.032;
model conv = t h c t2 h2 c2 th tc hc; run;proc print data = b2i
run;

```

```
var t h c th tc hc t2 h2 c2;
```

specifies the specific variables from which to create the principal components. In this case, the variables are all of the regressors. The statement

```
ods select eigenvectors eigenvalues;
```

creates the eigenvectors and eigenvalues. The other two ods statements set up the output. This procedure creates the principal component, names them prin1, prin2, and so on, and stores them in the output data set, which in this example is

TABLE 9.15 SAS Code to Perform Principal-Component Regression for Acetylene Data

```

proc princomp data = acetylene out = pc_acetylene std;
var t h c th tc he t2 h2 c2;
ods select eigenvectors eigenvalues;
ods trace on;
ods show;
run;
proc reg data = pc_acetylene;
model conv = prin1 prin2 prin3 prin4 prin5 prin6 prin7 prin8 prin9 / vif;
run;
proc reg data = pc_acetylene;
model conv = prin1;
run;
proc reg data = pc_acetylene;
model conv = prin1 prin2;
run;

```

pc_acetylene

The remainder of the code illustrates how to use `proc reg` with the principal components as the regressors. SAS does not automatically convert the resulting regression equation in the principal components back to the original variables. The analyst must perform this calculation using the appropriate eigenvectors.

PROBLEMS

- 9.1** Consider the soft drink delivery time data in Example 3.1.
- Find the simple correlation between cases (x_1) and distance (x_2).
 - Find the variance inflation factors.
 - Find the condition number of $\mathbf{X}'\mathbf{X}$. Is there evidence of multicollinearity in these data?
- 9.2** Consider the Hald cement data in Table B.21.
- From the matrix of correlations between the regressors, would you suspect that multicollinearity is present?
 - Calculate the variance inflation factors.
 - Find the eigenvalues of $\mathbf{X}'\mathbf{X}$.
 - Find the condition number of $\mathbf{X}'\mathbf{X}$.
- 9.3** Using the Hald cement data (Example 10.1), find the eigenvector associated with the smallest eigenvalue of $\mathbf{X}'\mathbf{X}$. Interpret the elements of this vector. What can you say about the source of multicollinearity in these data?
- 9.4** Find the condition indices and the variance decomposition proportions for the Hald cement data (Table B.21), assuming centered regressors. What can you say about multicollinearity in these data?

- 9.5** Repeat Problem 9.4 without centering the regressors and compare the results. Which approach do you think is better?
- 9.6** Use the regressors x_2 (passing yardage), x_7 (percentage of rushing plays), and x_8 (opponents' yards rushing) for the National Football League data in Table B.1.
- Does the correlation matrix give any indication of multicollinearity?
 - Calculate the variance inflation factors and the condition number of $\mathbf{X}'\mathbf{X}$. Is there any evidence of multicollinearity?
- 9.7** Consider the gasoline mileage data in Table B.3.
- Does the correlation matrix give any indication of multicollinearity?
 - Calculate the variance inflation factors and the condition number of $\mathbf{X}'\mathbf{X}$. Is there any evidence of multicollinearity?
- 9.8** Using the gasoline mileage data in Table B.3 find the eigenvectors associated with the smallest eigenvalues of $\mathbf{X}'\mathbf{X}$. Interpret the elements of these vectors. What can you say about the source of multicollinearity in these data?
- 9.9** Use the gasoline mileage data in Table B.3 and compute the condition indices and variance-decomposition proportions, with the regressors centered. What statements can you make about multicollinearity in these data?
- 9.10** Analyze the housing price data in Table B.4 for multicollinearity. Use the variance inflation factors and the condition number of $\mathbf{X}'\mathbf{X}$.
- 9.11** Analyze the chemical process data in Table B.5 for evidence of multicollinearity. Use the variance inflation factors and the condition number of $\mathbf{X}'\mathbf{X}$.
- 9.12** Analyze the patient satisfaction data in Table B.17 for multicollinearity.
- 9.13** Analyze the fuel consumption data in Table B.18 for multicollinearity.
- 9.14** Analyze the wine quality of young red wines data in Table B.19 for multicollinearity.
- 9.15** Analyze the methanol oxidation data in Table B.20 for multicollinearity.
- 9.16** The table below shows the condition indices and variance decomposition proportions for the acetylene data using centered regressors. Use this information to diagnose multicollinearity in the data and draw appropriate conclusions.

Number	Eigenvalue	Condition Indices	Variance Decomposition Proportions								
			T	H	C	TH	TC	HC	T2	H2	C2
1	4.204797	1.000000	0.0001	0.0024	0.0001	0.0004	0.0000	0.0004	0.0000	0.0001	0.0000
2	2.162611	1.394387	0.0000	0.0305	0.0000	0.0044	0.0000	0.0035	0.0000	0.0412	0.0000
3	1.138392	1.921882	0.0010	0.0000	0.0003	0.0002	0.0000	0.0001	0.0001	0.0139	0.0000
4	1.041305	2.009480	0.0000	0.2888	0.0000	0.0040	0.0000	0.0032	0.0000	0.0354	0.0000
5	0.384532	3.306788	0.0001	0.5090	0.0000	0.0023	0.0000	0.0029	0.0000	0.4425	0.0000
6	0.049510	9.215620	0.0034	0.0049	0.0000	0.0874	0.0000	0.0565	0.0033	0.0319	0.0071
7	0.013633	17.562062	0.0096	0.0051	0.0031	0.8218	0.0000	0.7922	0.0042	0.0001	0.0053
8	0.0051232	28.648589	0.1514	0.0936	0.1461	0.0773	0.0007	0.1210	0.0002	0.3526	0.0229
9	0.0000969	208.285	0.8343	0.0657	0.8504	0.0022	0.9993	0.0201	0.9920	0.0822	0.9646

- 9.17** Apply ridge regression to the Hald cement data in Table B.21.
- Use the ridge trace to select an appropriate value of k . Is the final model a good one?
 - How much inflation in the residual sum of squares has resulted from the use of ridge regression?
 - Compare the ridge regression model with the two-regressor model involving x_1 and x_2 developed by all possible regressions in Example 9.1.
- 9.18** Use ridge regression on the Hald cement data (Table B.21) using the value of k in Eq. (9.8). Compare this value of k value selected by the ridge trace in Problem 9.17. Does the final model differ greatly from the one in Problem 9.17?
- 9.19** Estimate the parameters in a model for the gasoline mileage data in Table B.3 using ridge regression.
- Use the ridge trace to select an appropriate value of k . Is the resulting model adequate?
 - How much inflation in the residual sum of squares has resulted from the use of ridge regression?
 - How much reduction in R^2 has resulted from the use of ridge regression?
- 9.20** Estimate the parameters in a model for the gasoline mileage data in Table B.3 using ridge regression with the value of k determined by Eq. (9.8). Does this model differ dramatically from the one developed in Problem 9.19?
- 9.21** Estimate model parameters for the Hald cement data (Table B.21) using principal-component regression.
- What is the loss in R^2 for this model compared to least squares?
 - How much shrinkage in the coefficient vector has resulted?
 - Compare the principal-component model with the ordinary ridge model developed in Problem 9.17. Comment on any apparent differences in the models.
- 9.22** Estimate the model parameters for the gasoline mileage data using principal-component regression.
- How much has the residual sum of squares increased compared to least squares?
 - How much shrinkage in the coefficient vector has resulted?
 - Compare the principal-component and ordinary ridge models (Problem 9.19). Which model do you prefer?
- 9.23** Consider the air pollution and mortality data given in Table B.15.
- Is there a problem with collinearity? Discuss how you arrived at this decision.
 - Perform a ridge trace on these data.
 - Select a k based upon the ridge trace from part b. Which estimates of the coefficients do you prefer for these data, ridge or OLS? Justify your answer.

- d. Use principal-component regression to analyze these data. Discuss the principal-component regression results with the ridge regression and OLS results.

- 9.24 Show that the ridge estimator is the solution to the problem

$$\begin{aligned} & \underset{\beta}{\text{Minimize}} \quad (\beta - \hat{\beta})' \mathbf{X}'\mathbf{X}(\beta - \hat{\beta}) \\ & \text{subject to} \quad \beta'\beta \leq d^2 \end{aligned}$$

- 9.25 **Pure Shrinkage Estimators (Stein [1960]).** The pure shrinkage estimator is defined as $\hat{\beta}_s = c\hat{\beta}$, where $0 \leq c \leq 1$ is a constant chosen by the analyst. Describe the kind of shrinkage that this estimator introduces, and compare it with the shrinkage that results from ridge regression. Intuitively, which estimator seems preferable?

- 9.26 Show that the pure shrinkage estimator (Problem 9.25) is the solution to

$$\begin{aligned} & \underset{\beta}{\text{Minimize}} \quad (\beta - \hat{\beta})' (\beta - \hat{\beta}) \\ & \text{subject to} \quad \beta'\beta \leq d^2 \end{aligned}$$

- 9.27 The mean square error criterion for ridge regression is

$$E(L_1^2) = \sum_{j=1}^p \frac{\lambda_j}{(\lambda_j + k)^2} + \sum_{j=1}^p \frac{\alpha_j^2 k^2}{(\lambda_j + k)^2}$$

Try to find the value of k that minimizes $E(L_1^2)$. What difficulties are encountered?

- 9.28 Consider the mean square error criterion for generalized ridge regression. Show that the mean square error is minimized by choosing $k_j = \sigma^2 / \alpha_j^2$, $j = 1, 2, \dots, p$.
- 9.29 Show that if $\mathbf{X}'\mathbf{X}$ is in correlation form, $\mathbf{\Lambda}$ is the diagonal matrix of eigenvalues of $\mathbf{X}'\mathbf{X}$, and \mathbf{T} is the corresponding matrix of eigenvectors, then the variance inflation factors are the main diagonal elements of $\mathbf{T}\mathbf{\Lambda}^{-1}\mathbf{T}'$.

CHAPTER 10

VARIABLE SELECTION AND MODEL BUILDING

10.1 INTRODUCTION

10.1.1 Model-Building Problem

In the preceding chapters we have assumed that the regressor variables included in the model are known to be important. Our focus was on techniques to ensure that the functional form of the model was correct and that the underlying assumptions were not violated. In some applications theoretical considerations or prior experience can be helpful in selecting the regressors to be used in the model.

In previous chapters, we have employed the classical approach to regression model selection, which assumes that we have a very good idea of the basic form of the model and that we know all (or nearly all) of the regressors that should be used. Our basic strategy is as follows:

1. Fit the full model (the model with all of the regressors under consideration).
2. Perform a thorough analysis of this model, including a full residual analysis. Often, we should perform a thorough analysis to investigate possible collinearity.
3. Determine if transformations of the response or of some of the regressors are necessary.
4. Use the t tests on the individual regressors to edit the model.
5. Perform a thorough analysis of the edited model, especially a residual analysis, to determine the model's adequacy.

In most practical problems, especially those involving historical data, the analyst has a rather large pool of possible **candidate regressors**, of which only a few are likely to be important. Finding an appropriate subset of regressors for the model is often called the **variable selection problem**.

Good variable selection methods are very important in the presence of multicollinearity. Frankly, the most common corrective technique for multicollinearity is variable selection. Variable selection does not guarantee elimination of multicollinearity. There are cases where two or more regressors are highly related; yet, some subset of them really does belong in the model. Our variable selection methods help to justify the presence of these highly related regressors in the final model.

Multicollinearity is not the only reason to pursue variable selection techniques. Even mild relationships that our multicollinearity diagnostics do not flag as problematic can have an impact on model selection. The use of good model selection techniques increases our confidence in the final model or models recommended.

Building a regression model that includes only a subset of the available regressors involves two conflicting objectives. (1) We would like the model to include as many regressors as possible so that the information content in these factors can influence the predicted value of y . (2) We want the model to include as few regressors as possible because the variance of the prediction \hat{y} increases as the number of regressors increases. Also the more regressors there are in a model, the greater the costs of data collection and model maintenance. The process of finding a model that is a compromise between these two objectives is called selecting the **“best” regression equation**. Unfortunately, as we will see in this chapter, there is no unique definition of “best.” Furthermore, there are several algorithms that can be used for variable selection, and these procedures frequently specify different subsets of the candidate regressors as best.

The variable selection problem is often discussed in an idealized setting. It is usually assumed that the correct functional specification of the regressors is known (e.g., $1/x_1$, $\ln x_2$) and that no outliers or influential observations are present. In practice, these assumptions are rarely met. **Residual analysis**, such as described in Chapter 4, is useful in revealing functional forms for regressors that might be investigated, in pointing out new candidate regressors, and for identifying defects in the data such as outliers. The effect of **influential** or **high-leverage observations** should also be determined. Investigation of model adequacy is linked to the variable selection problem. Although ideally these problems should be solved simultaneously, an iterative approach is often employed, in which (1) a particular variable selection strategy is employed and then (2) the resulting subset model is checked for correct functional specification, outliers, and influential observations. This may indicate that step 1 must be repeated. Several iterations may be required to produce an adequate model.

None of the variable selection procedures described in this chapter are guaranteed to produce the best regression equation for a given data set. In fact, there usually is not a single best equation but rather several equally good ones. Because variable selection algorithms are heavily computer dependent, the analyst is sometimes tempted to place too much reliance on the results of a particular procedure. Such temptation is to be avoided. Experience, professional judgment in the subject-matter field, and subjective considerations all enter into the variable selection problem. Variable selection procedures should be used by the analyst as methods

to explore the structure of the data. Good general discussions of variable selection in regression include Cox and Snell [1974], Hocking [1972, 1976], Hocking and LaMotte [1973], Myers [1990], and Thompson [1978a, b].

10.1.2 Consequences of Model Misspecification

To provide motivation for variable selection we will briefly review the consequences of **incorrect model specification**. Assume that there are K candidate regressors x_1, x_2, \dots, x_K and $n \geq K + 1$ observations on these regressors and the response y . The **full model**, containing all K regressors, is

$$y_i = \beta_0 + \sum_{j=1}^K \beta_j x_{ij} + \varepsilon_i, \quad i = 1, 2, \dots, n \quad (10.1a)$$

or equivalently

$$\mathbf{y} = \mathbf{X}\boldsymbol{\beta} + \boldsymbol{\varepsilon} \quad (10.1b)$$

We assume that the list of candidate regressors contains all the important variables. Note that Eq. (10.1) contains an intercept term β_0 . While β_0 could also be a candidate for selection, it is typically forced into the model. We assume that all equations include an intercept term. Let r be the number of regressors that are deleted from Eq. (10.1). Then the number of variables that are retained is $p = K + 1 - r$. Since the intercept is included, the subset model contains $p - 1 = K - r$ of the original regressors.

The model (10.1) may be written as

$$\mathbf{y} = \mathbf{X}_p \boldsymbol{\beta}_p + \mathbf{X}_r \boldsymbol{\beta}_r + \boldsymbol{\varepsilon} \quad (10.2)$$

where the \mathbf{X} matrix has been partitioned into \mathbf{X}_p , an $n \times p$ matrix whose columns represent the intercept and the $p - 1$ regressors to be retained in the subset model, and \mathbf{X}_r , an $n \times r$ matrix whose columns represent the regressors to be deleted from the full model. Let $\boldsymbol{\beta}$ be partitioned conformably into $\boldsymbol{\beta}_p$ and $\boldsymbol{\beta}_r$. For the full model the least-squares estimate of $\boldsymbol{\beta}$ is

$$\hat{\boldsymbol{\beta}}^* = (\mathbf{X}'\mathbf{X})^{-1} \mathbf{X}'\mathbf{y} \quad (10.3)$$

and an estimate of the residual variance σ^2 is

$$\hat{\sigma}^2 = \frac{\mathbf{y}'\mathbf{y} - \hat{\boldsymbol{\beta}}^{*\prime} \mathbf{X}'\mathbf{y}}{n - K - 1} = \frac{\mathbf{y}'[\mathbf{I} - \mathbf{X}(\mathbf{X}'\mathbf{X})^{-1} \mathbf{X}']\mathbf{y}}{n - K - 1} \quad (10.4)$$

The components of $\hat{\boldsymbol{\beta}}^*$ are denoted by $\hat{\boldsymbol{\beta}}_p^*$ and $\hat{\boldsymbol{\beta}}_r^*$, and \hat{y}_i^* denotes the fitted values. For the subset model

$$\mathbf{y} = \mathbf{X}_p \boldsymbol{\beta}_p + \boldsymbol{\varepsilon} \quad (10.5)$$

the least-squares estimate of β_p is

$$\hat{\beta}_p = (\mathbf{X}'_p \mathbf{X}_p)^{-1} \mathbf{X}'_p \mathbf{y} \quad (10.6)$$

the estimate of the residual variance is

$$\hat{\sigma}^2 = \frac{\mathbf{y}'\mathbf{y} - \hat{\beta}'_p \mathbf{X}'_p \mathbf{y}}{n-p} = \frac{\mathbf{y}' [\mathbf{I} - \mathbf{X}_p (\mathbf{X}'_p \mathbf{X}_p)^{-1} \mathbf{X}'_p] \mathbf{y}}{n-p} \quad (10.7)$$

and the fitted values are \hat{y}_i .

The properties of the estimates $\hat{\beta}_p$ and $\hat{\sigma}^2$ from the subset model have been investigated by several authors, including Hocking [1974, 1976], Narula and Ramberg [1972], Rao [1971], Rosenberg and Levy [1972], and Walls and Weeks [1969].

The results can be summarized as follows:

1. The expected value of $\hat{\beta}_p$ is

$$E(\hat{\beta}_p) = \beta_p + (\mathbf{X}'_p \mathbf{X}_p)^{-1} \mathbf{X}'_p \mathbf{X}_r \beta_r = \beta_p + \mathbf{A} \beta_r$$

where $\mathbf{A} = (\mathbf{X}'_p \mathbf{X}_p)^{-1} \mathbf{X}'_p \mathbf{X}_r$ (\mathbf{A} is sometimes called the alias matrix). Thus, $\hat{\beta}_p$ is a biased estimate of β_p unless the regression coefficients corresponding to the deleted variables (β_r) are zero or the retained variables are orthogonal to the deleted variables ($\mathbf{X}'_p \mathbf{X}_r = \mathbf{0}$).

2. The variances of $\hat{\beta}_p$ and $\hat{\beta}^*$ are $\text{Var}(\hat{\beta}_p) = \sigma^2 (\mathbf{X}'_p \mathbf{X}_p)^{-1}$ and $\text{Var}(\hat{\beta}^*) = \sigma^2 (\mathbf{X}' \mathbf{X})^{-1}$, respectively. Also the matrix $\text{Var}(\hat{\beta}_p) - \text{Var}(\hat{\beta}^*)$ is positive semidefinite, that is, the variances of the least-squares estimates of the parameters in the full model are greater than or equal to the variances of the corresponding parameters in the subset model. Consequently, deleting variables never increases the variances of the estimates of the remaining parameters.
3. Since $\hat{\beta}_p$ is a biased estimate of β_p and $\hat{\beta}^*$ is not, it is more reasonable to compare the precision of the parameter estimates from the full and subset models in terms of mean square error. Recall that if $\hat{\theta}$ is an estimate of the parameter θ , the mean square error of $\hat{\theta}$ is

$$\text{MSE}(\hat{\theta}) = \text{Var}(\hat{\theta}) + [E(\hat{\theta}) - \theta]^2$$

The mean square error of $\hat{\beta}_p$ is

$$\text{MSE}(\hat{\beta}_p) = \sigma^2 (\mathbf{X}'_p \mathbf{X}_p)^{-1} + \mathbf{A} \beta_r \beta_r' \mathbf{A}'$$

If the matrix $\text{Var}(\hat{\beta}^*) - \beta_r \beta_r'$ is positive semidefinite, the matrix $\text{Var}(\hat{\beta}_p) - \text{MSE}(\hat{\beta}_p)$ is positive semidefinite. This means that the least-squares estimates of the parameters in the subset model have smaller mean square error than the corresponding parameter estimates from the full model when the deleted variables have regression coefficients that are smaller than the standard errors of their estimates in the full model.

4. The parameter $\hat{\sigma}^2$ from the full model is an unbiased estimate of σ^2 . However, for the subset model

$$E(\hat{\sigma}^2) = \sigma^2 + \frac{\boldsymbol{\beta}'_r \mathbf{X}'_r [\mathbf{I} - \mathbf{X}_p (\mathbf{X}'_p \mathbf{X}_p)^{-1} \mathbf{X}'_p] \mathbf{X}_r \boldsymbol{\beta}_r}{n - p}$$

That is, $\hat{\sigma}^2$ is generally biased upward as an estimate of σ^2 .

5. Suppose we wish to predict the response at the point $\mathbf{x}' = [\mathbf{x}'_p, \mathbf{x}'_r]$. If we use the full model, the predicted value is $\hat{y}^* = \mathbf{x}' \hat{\boldsymbol{\beta}}^*$, with mean $\mathbf{x}' \boldsymbol{\beta}$ and prediction variance

$$\text{Var}(\hat{y}^*) = \sigma^2 [1 + \mathbf{x}' (\mathbf{X}' \mathbf{X})^{-1} \mathbf{x}]$$

However, if the subset model is used, $\hat{y} = \mathbf{x}'_p \hat{\boldsymbol{\beta}}_p$ with mean

$$E(\hat{y}) = \mathbf{x}'_p \boldsymbol{\beta}_p + \mathbf{x}'_p \mathbf{A} \boldsymbol{\beta}_r$$

and prediction mean square error

$$\text{MSE}(\hat{y}) = \sigma^2 [1 + \mathbf{x}'_p (\mathbf{X}'_p \mathbf{X}_p)^{-1} \mathbf{x}_p] + (\mathbf{x}'_p \mathbf{A} \boldsymbol{\beta}_r - \mathbf{x}'_p \boldsymbol{\beta}_r)^2$$

Note that \hat{y} is a biased estimate of y unless $\mathbf{x}'_p \mathbf{A} \boldsymbol{\beta}_r = 0$, which is only true in general if $\mathbf{X}'_p \mathbf{X}_r \boldsymbol{\beta}_r = \mathbf{0}$. Furthermore, the variance of \hat{y}^* from the full model is not less than the variance of \hat{y} from the subset model. In terms of mean square error we can show that

$$\text{Var}(\hat{y}^*) \geq \text{MSE}(\hat{y})$$

provided that the matrix $\text{Var}(\hat{\boldsymbol{\beta}}_r) - \boldsymbol{\beta}_r \boldsymbol{\beta}'_r$ is positive semidefinite.

Our motivation for variable selection can be summarized as follows. By deleting variables from the model, we may **improve the precision** of the parameter estimates of the retained variables even though some of the deleted variables are not negligible. This is also true for the variance of a predicted response. Deleting variables potentially introduces **bias** into the estimates of the coefficients of retained variables and the response. However, if the deleted variables have small effects, the MSE of the biased estimates will be less than the variance of the unbiased estimates. That is, the amount of bias introduced is less than the reduction in the variance. There is danger in retaining negligible variables, that is, variables with zero coefficients or coefficients less than their corresponding standard errors from the full model. This danger is that the variances of the estimates of the parameters and the predicted response are increased.

Finally, remember from Section 1.2 that regression models are frequently built using retrospective data, that is, data that have been extracted from historical records. These data are often saturated with defects, including outliers, “wild” points, and inconsistencies resulting from changes in the organization’s data collection and information-processing system over time. These data defects can have great impact

on the variable selection process and lead to model misspecification. A very common problem in historical data is to find that some candidate regressors have been controlled so that they vary over a very limited range. These are often the most influential variables, and so they were tightly controlled to keep the response within acceptable limits. Yet because of the limited range of the data, the regressor may seem unimportant in the least-squares fit. This is a serious model misspecification that only the model builder's nonstatistical knowledge of the problem environment may prevent. When the range of variables thought to be important is tightly controlled, the analyst may have to collect new data specifically for the model-building effort. Designed experiments are helpful in this regard.

10.1.3 Criteria for Evaluating Subset Regression Models

Two key aspects of the variable selection problem are generating the subset models and deciding if one subset is better than another. In this section we discuss criteria for evaluating and comparing subset regression models. Section 10.2 will present computational methods for variable selection.

Coefficient of Multiple Determination A measure of the adequacy of a regression model that has been widely used is the coefficient of multiple determination, R^2 . Let R_p^2 denote the coefficient of multiple determination for a subset regression model with p terms, that is, $p - 1$ regressors and an intercept term β_0 . Computationally,

$$R_p^2 = \frac{SS_R(p)}{SS_T} = 1 - \frac{SS_{\text{Res}}(p)}{SS_T} \quad (10.8)$$

where $SS_R(p)$ and $SS_{\text{Res}}(p)$ denote the regression sum of squares and the residual sum of squares, respectively, for a p -term subset model. Note that there are $\binom{K}{p-1}$ values of R_p^2 for each value of p , one for each possible subset model of size p . Now R_p^2 increases as p increases and is a maximum when $p = K + 1$. Therefore, the analyst uses this criterion by adding regressors to the model up to the point where an additional variable is not useful in that it provides only a small increase in R_p^2 . The general approach is illustrated in Figure 10.1, which presents a hypothetical plot of the maximum value of R_p^2 for each subset of size p against p . Typically one examines a display such as this and then specifies the number of regressors for the final model as the point at which the "knee" in the curve becomes apparent. Clearly this requires judgment on the part of the analyst.

Since we cannot find an "optimum" value of R^2 for a subset regression model, we must look for a "satisfactory" value. Aitkin [1974] has proposed one solution to this problem by providing a test by which all subset regression models that have an R^2 not significantly different from the R^2 for the full model can be identified. Let

$$R_0^2 = 1 - (1 - R_{K+1}^2)(1 + d_{\alpha,n,K}) \quad (10.9)$$

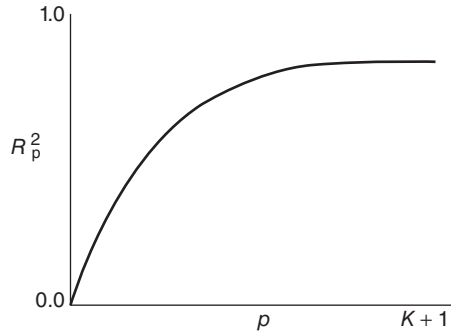

Figure 10.1 Plot of R_p^2 versus p .

where

$$d_{\alpha,n,K} = \frac{KF_{\alpha,K,n-K-1}}{n-K-1}$$

and R_{K+1}^2 is the value of R^2 for the full model. Aitkin calls any subset of regressor variables producing an R^2 greater than R_0^2 an **R^2 -adequate (α) subset**.

Generally, it is not straightforward to use R^2 as a criterion for choosing the number of regressors to include in the model. However, for a fixed number of variables p , R_p^2 can be used to compare the $\binom{K}{p-1}$ subset models so generated. Models having large values of R_p^2 are preferred.

Adjusted R^2 To avoid the difficulties of interpreting R^2 , some analysts prefer to use the adjusted R^2 statistic, defined for a p -term equation as

$$R_{\text{Adj},p}^2 = 1 - \left(\frac{n-1}{n-p} \right) (1 - R_p^2) \tag{10.10}$$

The $R_{\text{Adj},p}^2$ statistic does not necessarily increase as additional regressors are introduced into the model. In fact, it can be shown (Edwards [1969], Haitovski [1969], and Seber [1977]) that if s regressors are added to the model, $R_{\text{Adj},p+s}^2$ will exceed $R_{\text{Adj},p}^2$ if and only if the partial F statistic for testing the significance of the s additional regressors exceeds 1. Consequently, one criterion for selection of an optimum subset model is to choose the model that has a maximum $R_{\text{Adj},p}^2$. However, this is equivalent to another criterion that we now present.

Residual Mean Square The residual mean square for a subset regression model, for example,

$$MS_{\text{Res}}(p) = \frac{SS_{\text{Res}}(p)}{n-p} \tag{10.11}$$

may be used as a model evaluation criterion. The general behavior of $MS_{\text{Res}}(p)$ as p increases is illustrated in Figure 10.2. Because $SS_{\text{Res}}(p)$ always decreases

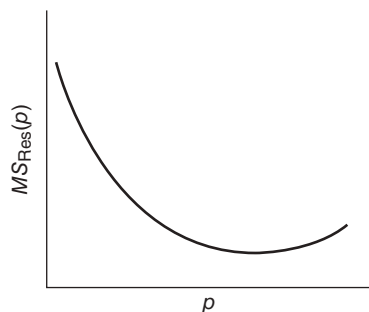

Figure 10.2 Plot of $MS_{\text{Res}}(p)$ versus p .

as p increases, $MS_{\text{Res}}(p)$ initially decreases, then stabilizes, and eventually may increase. The eventual increase in $MS_{\text{Res}}(p)$ occurs when the reduction in $SS_{\text{Res}}(p)$ from adding a regressor to the model is not sufficient to compensate for the loss of one degree of freedom in the denominator of Eq. (10.11). That is, adding a regressor to a p -term model will cause $MS_{\text{Res}}(p+1)$ to be greater than $MS_{\text{Res}}(p)$ if the decrease in the residual sum of squares is less than $MS_{\text{Res}}(p)$. Advocates of the $MS_{\text{Res}}(p)$ criterion will plot $MS_{\text{Res}}(p)$ versus p and base the choice of p on the following:

1. The minimum $MS_{\text{Res}}(p)$
2. The value of p such that $MS_{\text{Res}}(p)$ is approximately equal to MS_{Res} for the full model
3. A value of p near the point where the smallest $MS_{\text{Res}}(p)$ turns upward

The subset regression model that minimizes $MS_{\text{Res}}(p)$ will also maximize $R_{\text{Adj},p}^2$. To see this, note that

$$R_{\text{Adj},p}^2 = 1 - \frac{n-1}{n-p} (1 - R_p^2) = 1 - \frac{n-1}{n-p} \frac{SS_{\text{Res}}(p)}{SS_{\text{T}}} = 1 - \frac{MS_{\text{Res}}(p)}{SS_{\text{T}}/(n-1)}$$

Thus, the criteria minimum $MS_{\text{Res}}(p)$ and maximum adjusted R^2 are equivalent.

Mallows's C_p Statistic Mallows [1964, 1966, 1973, 1995] has proposed a criterion that is related to the mean square error of a fitted value, that is,

$$E[\hat{y}_i - E(y_i)]^2 = [E(y_i) - E(\hat{y}_i)]^2 + \text{Var}(\hat{y}_i) \quad (10.12)$$

Note that $E(y_i)$ is the expected response from the true regression equation and $E(\hat{y}_i)$ is the expected response from the p -term subset model. Thus, $E(y_i) - E(\hat{y}_i)$ is the bias at the i th data point. Consequently, the two terms on the right-hand side of Eq. (10.12) are the **squared bias** and **variance** components, respectively, of the mean square error. Let the total squared bias for a p -term equation be

$$SS_{\text{B}}(p) = \sum_{i=1}^n [E(y_i) - E(\hat{y}_i)]^2$$

and define the standardized total mean square error as

$$\begin{aligned}\Gamma_p &= \frac{1}{\sigma^2} \left\{ \sum_{i=1}^n [E(y_i) - E(\hat{y}_i)]^2 + \sum_{i=1}^n \text{Var}(\hat{y}_i) \right\} \\ &= \frac{SS_B(p)}{\sigma^2} + \frac{1}{\sigma^2} \sum_{i=1}^n \text{Var}(\hat{y}_i)\end{aligned}\quad (10.13)$$

It can be shown that

$$\sum_{i=1}^n \text{Var}(\hat{y}_i) = p\sigma^2$$

and that the expected value of the residual sum of squares from a p -term equation is

$$E[SS_{\text{Res}}(p)] = SS_B(p) + (n-p)\sigma^2$$

Substituting for $\sum_{i=1}^n \text{Var}(\hat{y}_i)$ and $SS_B(p)$ in Eq. (10.13) gives

$$\Gamma_p = \frac{1}{\sigma^2} \{ E[SS_{\text{Res}}(p)] - (n-p)\sigma^2 + p\sigma^2 \} = \frac{E[SS_{\text{Res}}(p)]}{\sigma^2} - n + 2p \quad (10.14)$$

Suppose that $\hat{\sigma}^2$ is a good estimate of σ^2 . Then replacing $E[SS_{\text{Res}}(p)]$ by the observed value $SS_{\text{Res}}(p)$ produces an estimate of Γ_p , say

$$C_p = \frac{SS_{\text{Res}}(p)}{\hat{\sigma}^2} - n + 2p \quad (10.15)$$

If the p -term model has negligible bias, then $SS_B(p) = 0$. Consequently, $E[SS_{\text{Res}}(p)] = (n-p)\sigma^2$, and

$$E[C_p | \text{Bias} = 0] = \frac{(n-p)\sigma^2}{\sigma^2} - n + 2p = p$$

When using the C_p criterion, it can be helpful to visualize the plot of C_p as a function of p for each regression equation, such as shown in Figure 10.3. Regression equations with little bias will have values of C_p that fall near the line $C_p = p$ (point *A* in Figure 10.3) while those equations with substantial bias will fall above this line (point *B* in Figure 10.3). Generally, **small values of C_p are desirable**. For example, although point *C* in Figure 10.3 is above the line $C_p = p$, it is below point *A* and thus represents a model with lower total error. It may be preferable to accept some bias in the equation to reduce the average error of prediction.

To calculate C_p , we need an unbiased estimate of σ^2 . Frequently we use the residual mean square for the full equation for this purpose. However, this forces $C_p = p = K + 1$ for the full equation. Using $MS_{\text{Res}}(K + 1)$ from the full model as an estimate of σ^2 assumes that the full model has negligible bias. If the full model has several regressors that do not contribute significantly to the model (zero regression coefficients), then $MS_{\text{Res}}(K + 1)$ will often overestimate σ^2 , and consequently

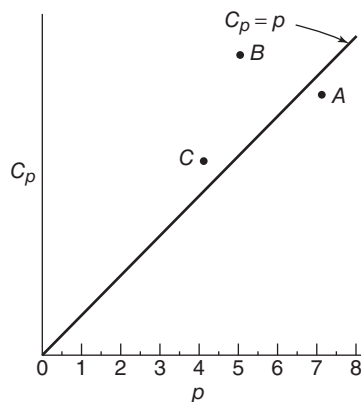

Figure 10.3 A C_p plot.

the values of C_p will be small. If the C_p statistic is to work properly, a good estimate of σ^2 must be used. As an alternative to $MS_{\text{Res}}(K+1)$, we could base our estimate of σ^2 on pairs of points that are “near neighbors” in x space, as illustrated in Section 4.5.2.

The Akaike Information Criterion and Bayesian Analogues (BICs) Akaike proposed an information criterion, AIC, based on maximizing the expected *entropy* of the model. Entropy is simply a measure of the expected information, in this case the Kullback-Leibler information measure. Essentially, the AIC is a penalized log-likelihood measure. Let L be the likelihood function for a specific model. The AIC is

$$\text{AIC} = -2\ln(L) + 2p,$$

where p is the number of parameters in the model. In the case of ordinary least squares regression,

$$\text{AIC} = n \ln \left(\frac{SS_{\text{Res}}}{n} \right) + 2p.$$

The key insight to the AIC is similar to R_{Adj}^2 and Mallows C_p . As we add regressors to the model, SS_{Res} cannot increase. The issue becomes whether the decrease in SS_{Res} justifies the inclusion of the extra terms.

There are several Bayesian extensions of the AIC. Schwartz (1978) and Sawa (1978) are two of the more popular ones. Both are called BIC for Bayesian information criterion. As a result, it is important to check the fine print on the statistical software that one uses! The Schwartz criterion (BIC_{Sch}) is

$$\text{BIC}_{\text{Sch}} = -2\ln(L) + p \ln(n).$$

This criterion places a greater penalty on adding regressors as the sample size increases. For ordinary least squares regression, this criterion is

$$\text{BIC}_{\text{Sch}} = n \ln \left(\frac{SS_{\text{Res}}}{n} \right) + p \ln(n).$$

R uses this criterion as its BIC. SAS uses the Sawa criterion, which involves a more complicated penalty term. This penalty term involves σ^2 and σ^4 , which SAS estimates by MS_{Res} from the full model.

The AIC and BIC criteria are gaining popularity. They are much more commonly used in the model selection procedures involving more complicated modeling situations than ordinary least squares, for example, the mixed model situation outlined in Section 5.6. These criteria are very commonly used with generalized linear models (Chapter 13).

Uses of Regression and Model Evaluation Criteria As we have seen, there are several criteria that can be used to evaluate subset regression models. The criterion that we use for model selection should certainly be related to the intended use of the model. There are several possible uses of regression, including (1) data description, (2) prediction and estimation, (3) parameter estimation, and (4) control.

If the objective is to obtain a good description of a given process or to model a complex system, a search for regression equations with small residual sums of squares is indicated. Since SS_{Res} is minimized by using all K candidate regressors, we usually prefer to eliminate some variables if only a small increase in SS_{Res} results. In general, we would like to describe the system with as few regressors as possible while simultaneously explaining the substantial portion of the variability in y .

Frequently, regression equations are used for prediction of future observations or estimation of the mean response. In general, we would like to select the regressors such that the mean square error of prediction is minimized. This usually implies that regressors with small effects should be deleted from the model. One could also use the PRESS statistic introduced in Chapter 4 to evaluate candidate equations produced by a subset generation procedure. Recall that for a p -term regression model

$$\text{PRESS}_p = \sum_{i=1}^n [y_i - \hat{y}_{(i)}]^2 = \sum_{i=1}^n \left(\frac{e_i}{1 - h_{ii}} \right)^2 \quad (10.16)$$

One then selects the subset regression model based on a small value of PRESS_p . While PRESS_p has intuitive appeal, particularly for the prediction problem, it is not a simple function of the residual sum of squares, and developing an algorithm for variable selection based on this criterion is not straightforward. This statistic is, however, potentially useful for discriminating between alternative models, as we will illustrate.

If we are interested in parameter estimation, then clearly we should consider both the bias that results from deleting variables and the variances of the estimated coefficients. When the regressors are highly multicollinear, the least-squares estimates of the individual regression coefficients may be extremely poor, as we saw in Chapter 9.

When a regression model is used for control, accurate estimates of the parameters are important. This implies that the standard errors of the regression coefficients should be small. Furthermore, since the adjustments made on the x 's to control y

will be proportional to the $\hat{\beta}$'s, the regression coefficients should closely represent the effects of the regressors. If the regressors are highly multicollinear, the $\hat{\beta}$'s may be very poor estimates of the effects of individual regressors.

10.2 COMPUTATIONAL TECHNIQUES FOR VARIABLE SELECTION

We have seen that it is desirable to consider regression models that employ a subset of the candidate regressor variables. To find the subset of variables to use in the final equation, it is natural to consider fitting models with various combinations of the candidate regressors. In this section we will discuss several computational techniques for generating subset regression models and illustrate criteria for evaluation of these models.

10.2.1 All Possible Regressions

This procedure requires that the analyst fit all the regression equations involving one candidate regressor, two candidate regressors, and so on. These equations are evaluated according to some suitable criterion and the “best” regression model selected. If we assume that the intercept term β_0 is included in all equations, then if there are K candidate regressors, there are 2^K total equations to be estimated and examined. For example, if $K = 4$, then there are $2^4 = 16$ possible equations, while if $K = 10$, there are $2^{10} = 1024$ possible regression equations. Clearly the number of equations to be examined increases rapidly as the number of candidate regressors increases. Prior to the development of efficient computer codes, generating all possible regressions was impractical for problems involving more than a few regressors. The availability of high-speed computers has motivated the development of several very efficient algorithms for all possible regressions. We illustrate Minitab and SAS in this chapter. The R function `leaps()` in the `leaps` directory performs an all possible regressions methodology.

Example 10.1 The Hald Cement Data

Hald [1952][†] presents data concerning the heat evolved in calories per gram of cement (y) as a function of the amount of each of four ingredients in the mix: tricalcium aluminate (x_1), tricalcium silicate (x_2), tetracalcium aluminato ferrite (x_3), and dicalcium silicate (x_4). The data are shown in Appendix Table B.21. These reflect quite serious problems with multicollinearity. The VIFs are:

x1: 38.496
 x2: 254.423
 x3: 46.868
 x4: 282.513

We will use these data to illustrate the all-possible-regressions approach to variable selection.

[†]These are “classical” data for illustrating the problems inherent in variable selection. For other analysis, see Daniel and Wood [1980], Draper and Smith [1998], and Seber [1977].

TABLE 10.1 Summary of All Possible Regressions for the Hald Cement Data

Number of Regressors in Model	p	Regressors in Model	$SS_{Res}(p)$	R_p^2	$R_{Adj,p}^2$	$MS_{Res}(p)$	C_p
None	1	None	2715.7635	0	0	226.3136	442.92
1	2	x_1	1265.6867	0.53395	0.49158	115.0624	202.55
1	2	x_2	906.3363	0.66627	0.63593	82.3942	142.49
1	2	x_3	1939.4005	0.28587	0.22095	176.3092	315.16
1	2	x_4	883.8669	0.67459	0.64495	80.3515	138.73
2	3	x_1x_2	57.9045	0.97868	0.97441	5.7904	2.68
2	3	x_1x_3	1227.0721	0.54817	0.45780	122.7073	198.10
2	3	x_1x_4	74.7621	0.97247	0.96697	7.4762	5.50
2	3	x_2x_3	415.4427	0.84703	0.81644	41.5443	62.44
2	3	x_2x_4	868.8801	0.68006	0.61607	86.8880	138.23
2	3	x_3x_4	175.7380	0.93529	0.92235	17.5738	22.37
3	4	$x_1x_2x_3$	48.1106	0.98228	0.97638	5.3456	3.04
3	4	$x_1x_2x_4$	47.9727	0.98234	0.97645	5.3303	3.02
3	4	$x_1x_3x_4$	50.8361	0.98128	0.97504	5.6485	3.50
3	4	$x_2x_3x_4$	73.8145	0.97282	0.96376	8.2017	7.34
4	5	$x_1x_2x_3x_4$	47.8636	0.98238	0.97356	5.9829	5.00

TABLE 10.2 Least-Squares Estimates for All Possible Regressions (Hald Cement Data)

Variables in Model	$\hat{\beta}_0$	$\hat{\beta}_1$	$\hat{\beta}_2$	$\hat{\beta}_3$	$\hat{\beta}_4$
x_1	81.479	1.869			
x_2	57.424		0.789		
x_3	110.203			-1.256	
x_4	117.568				-0.738
x_1x_2	52.577	1.468	0.662		
x_1x_3	72.349	2.312		0.494	
x_1x_4	103.097	1.440			-0.614
x_2x_3	72.075		0.731	-1.008	
x_2x_4	94.160		0.311		-0.457
x_3x_4	131.282			-1.200	-0.724
$x_1x_2x_3$	48.194	1.696	0.657	0.250	
$x_1x_2x_4$	71.648	1.452	0.416		-0.237
$x_2x_3x_4$	203.642		-0.923	-1.448	-1.557
$x_1x_3x_4$	111.684	1.052		-0.410	-0.643
$x_1x_2x_3x_4$	62.405	1.551	0.510	0.102	-0.144

Since there are $K = 4$ candidate regressors, there are $2^4 = 16$ possible regression equations if we always include the intercept β_0 . The results of fitting these 16 equations are displayed in Table 10.1. The R_p^2 , $R_{Adj,p}^2$, $MS_{Res}(p)$, and C_p statistics are also given in this table.

Table 10.2 displays the least-squares estimates of the regression coefficients. The partial nature of regression coefficients is readily apparent from examination of this

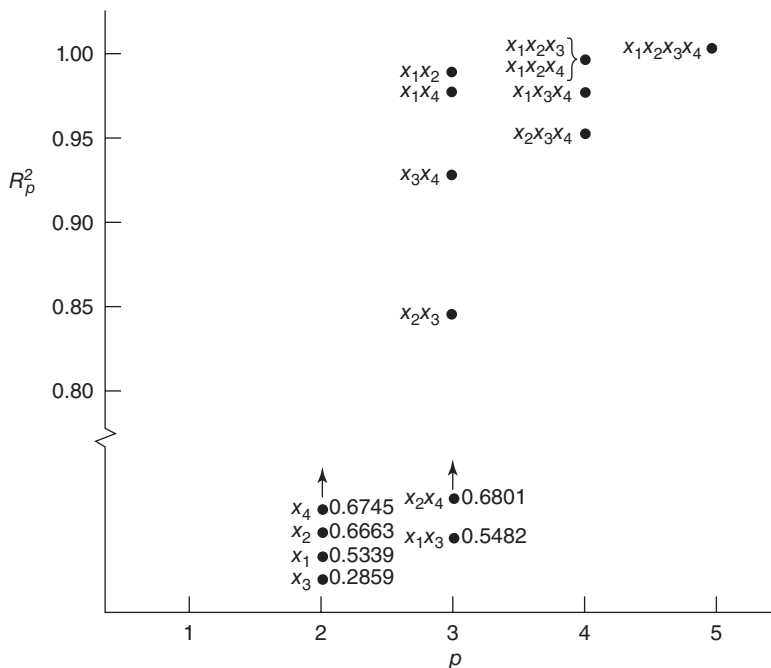

Figure 10.4 Plot of R_p^2 versus p , Example 10.1.

table. For example, consider x_2 . When the model contains only x_2 , the least-squares estimate of the x_2 effect is 0.789. If x_4 is added to the model, the x_2 effect is 0.311, a reduction of over 50%. Further addition of x_3 changes the x_2 effect to -0.923 . Clearly the least-squares estimate of an individual regression coefficient depends heavily on the **other** regressors in the model. The large changes in the regression coefficients observed in the Hald cement data are consistent with a serious problem with multicollinearity.

Consider evaluating the subset models by the R_p^2 criterion. A plot of R_p^2 versus p is shown in Figure 10.4. From examining this display it is clear that after two regressors are in the model, there is little to be gained in terms of R^2 by introducing additional variables. Both of the two-regressor models (x_1, x_2) and (x_1, x_4) have essentially the same R^2 values, and in terms of this criterion, it would make little difference which model is selected as the final regression equation. It may be preferable to use (x_1, x_4) because x_4 provides the best one-regressor model. From Eq. (10.9) we find that if we take $\alpha = 0.05$,

$$\begin{aligned}
 R_0^2 &= 1 - (1 - R_5^2) \left(1 + \frac{4F_{0.05,4,8}}{8} \right) \\
 &= 1 - 0.01762 \left[1 + \frac{4(3.84)}{8} \right] = 0.94855
 \end{aligned}$$

Therefore, any subset regression model for which $R_p^2 > R_0^2 = 0.94855$ is R^2 adequate (0.05); that is, its R^2 is not significantly different from R_{K+1}^2 . Clearly, several models

TABLE 10.3 Matrix of Simple Correlations for Hald's Data in Example 10.1

	x_1	x_2	x_3	x_4	y
x_1	1.0				
x_2	0.229	1.0			
x_3	-0.824	-0.139	1.0		
x_4	-0.245	-0.973	0.030	1.0	
y	0.731	0.816	-0.535	-0.821	1.0

in Table 10.1 satisfy this criterion, and so the choice of the final model is still not clear.

It is instructive to examine the pairwise correlations between x_i and x_j and between x_i and y . These simple correlations are shown in Table 10.3. Note that the pairs of regressors (x_1, x_3) and (x_2, x_4) are highly correlated, since

$$r_{13} = -0.824 \quad \text{and} \quad r_{24} = -0.973$$

Consequently, adding further regressors when x_1 and x_2 or when x_1 and x_4 are already in the model will be of little use since the information content in the excluded regressors is essentially present in the regressors that are in the model. This correlative structure is partially responsible for the large changes in the regression coefficients noted in Table 10.2.

A plot of $MS_{Res}(p)$ versus p is shown in Figure 10.5. The minimum residual mean square model is (x_1, x_2, x_4) , with $MS_{Res}(4) = 5.3303$. Note that, as expected, the model that minimizes $MS_{Res}(p)$ also maximizes the adjusted R^2 . However, two of the other three-regressor models $[(x_1, x_2, x_3)$ and $(x_1, x_3, x_4)]$ and the two-regressor models $[(x_1, x_2)$ and $(x_1, x_4)]$ have comparable values of the residual mean square. If either (x_1, x_2) or (x_1, x_4) is in the model, there is little reduction in residual mean square by adding further regressors. The subset model (x_1, x_2) may be more appropriate than (x_1, x_4) because it has a smaller value of the residual mean square.

A C_p plot is shown in Figure 10.6. To illustrate the calculations, suppose we take $\hat{\sigma} = 5.9829$ (MS_{Res} from the full model) and calculate C_3 for the model (x_1, x_4) . From Eq. (10.15) we find that

$$C_3 = \frac{SS_{Res}(3)}{\hat{\sigma}^2} - n + 2p = \frac{74.7621}{5.9829} - 13 + 2(3) = 5.50$$

From examination of this plot we find that there are four models that could be acceptable: (x_1, x_2) , (x_1, x_2, x_3) , (x_1, x_2, x_4) , and (x_1, x_3, x_4) . Without considering additional factors such as technical information about the regressors or the costs of data collection, it may be appropriate to choose the simplest model (x_1, x_2) as the final model because it has the smallest C_p .

This example has illustrated the computational procedure associated with model building with all possible regressions. Note that there is no clear-cut choice of the best regression equation. Very often we find that different criteria suggest different equations. For example, the minimum C_p equation is (x_1, x_2) and the minimum MS_{Res}

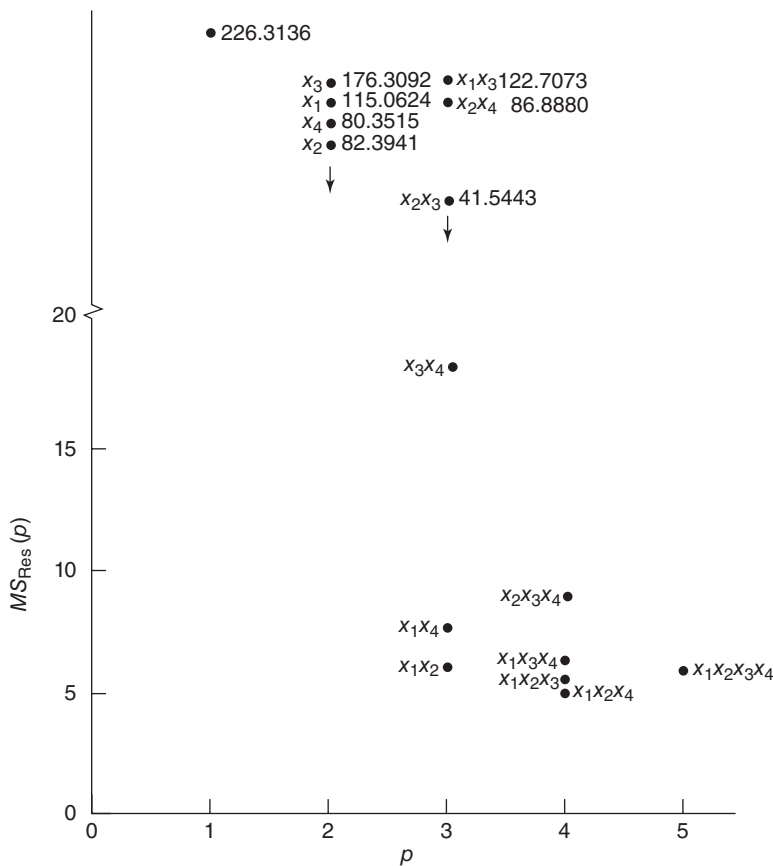

Figure 10.5 Plot of $MS_{Res}(p)$ versus p , Example 10.1.

equation is (x_1, x_2, x_4) . All “final” candidate models should be subjected to the usual tests for adequacy, including investigation of leverage points, influence, and multicollinearity. As an illustration, Table 10.4 examines the two models (x_1, x_2) and (x_1, x_2, x_4) with respect to PRESS and their variance inflation factors (VIFs). Both models have very similar values of PRESS (roughly twice the residual sum of squares for the minimum MS_{Res} equation), and the R^2 for prediction computed from PRESS is similar for both models. However, x_2 and x_4 are highly multicollinear, as evidenced by the larger variance inflation factors in (x_1, x_2, x_4) . Since both models have equivalent PRESS statistics, we would recommend the model with (x_1, x_2) based on the lack of multicollinearity in this model. ■

Efficient Generation of All Possible Regressions There are several algorithms potentially useful for generating all possible regressions. For example, see Furnival [1971], Furnival and Wilson [1974], Gartside [1965, 1971], Morgan and Tatar [1972], and Schatzoff, Tsao, and Fienberg [1968]. The basic idea underlying all these algorithms is to perform the calculations for the 2^K possible subset models in such a way that sequential subset models differ by only one variable. This allows very efficient

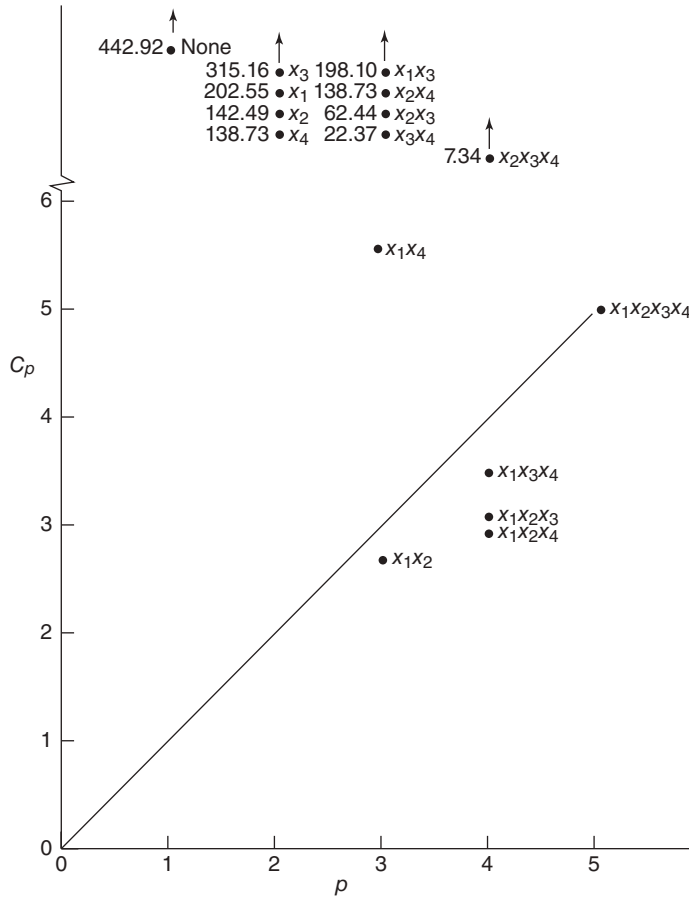

Figure 10.6 The C_p plot for Example 10.1.

numerical methods to be used in performing the calculations. These methods are usually based on either Gauss–Jordan reduction or the sweep operator (see Beaton [1964] or Seber [1977]). Some of these algorithms are available commercially. For example, the Furnival and Wilson [1974] algorithm is an option in the MINITAB and SAS computer programs.

A sample computer output for Minitab applied to the Hald cement data is shown in Figure 10.7. This program allows the user to select the best subset regression model of each size for $1 \leq p \leq K + 1$ and displays the C_p , R_p^2 , and $MS_{Res}(p)$ criteria. It also displays the values of the C_p , R_p^2 , $R_{Adj,p}^2$ and $S = \sqrt{MS_{Res}(p)}$ statistics for several (but not all) models for each value of p . The program has the capability of identifying the m best (for $m \leq 5$) subset regression models.

Current all-possible-regression procedures will very efficiently process up to about 30 candidate regressors with computing times that are comparable to the usual stepwise-type regression algorithms discussed in Section 10.2.2. Our experience indicates that problems with 30 or less candidate regressors can usually be solved relatively easily with an all-possible-regressions approach.

TABLE 10.4 Comparisons of Two Models for Hald's Cement Data

Observation <i>i</i>	$\hat{y} = 52.58 + 1.468x_1 + 0.662x_2^a$			$\hat{y} = 71.65 + 1.452x_1 + 0.416x_2 - 0.237x_4^b$		
	e_i	h_{ii}	$[e_i/(1 - h_{ii})]^2$	e_i	h_{ii}	$[e_i/(1 - h_{ii})]^2$
1	-1.5740	0.25119	4.4184	0.0617	0.52058	0.0166
2	-1.0491	0.26189	2.0202	1.4327	0.27670	3.9235
3	-1.5147	0.11890	2.9553	-1.8910	0.13315	4.7588
4	-1.6585	0.24225	4.7905	-1.8016	0.24431	5.6837
5	-1.3925	0.08362	2.3091	0.2562	0.35733	0.1589
6	4.0475	0.11512	20.9221	3.8982	0.11737	19.5061
7	-1.3031	0.36180	4.1627	-1.4287	0.36341	5.0369
8	-2.0754	0.24119	7.4806	-3.0919	0.34522	22.2977
9	1.8245	0.17195	4.9404	1.2818	0.20881	2.6247
10	1.3625	0.55002	9.1683	0.3539	0.65244	1.0368
11	3.2643	0.18402	16.0037	2.0977	0.32105	9.5458
12	0.8628	0.19666	1.1535	1.0556	0.20040	1.7428
13	-2.8934	0.21420	13.5579	-2.2247	0.25923	9.0194
		PRESS $x_1, x_2 = 93.8827$			PRESS $x_1, x_2, x_4 = 85.3516$	

^a $R^2_{\text{Prediction}} = 0.9654$, $VIF_1 = 1.05$, $VIF_2 = 1.06$.

^b $R^2_{\text{Prediction}} = 0.9684$, $VIF_1 = 1.07$, $VIF_2 = 18.78$, $VIF_4 = 18.94$.

Best Subsets Regression: y versus x1, x2, x3, x4

Response is y

Vars	R- Sq	R- Sq(adj)	C- p	S	X			
					1	2	3	4
1	67.5	64.5	138.7	8.9639				X
1	66.6	63.6	142.5	9.0771		X		
1	53.4	49.2	202.5	10.727	X			
1	28.6	22.1	315.2	13.278			X	
2	97.9	97.4	2.7	2.4063	X	X		
2	97.2	96.7	5.5	2.7343	X			X
2	93.5	92.2	22.4	4.1921			X	X
2	84.7	81.6	62.4	6.4455		X	X	
2	68.0	61.6	138.2	9.3214		X		X
3	98.2	97.6	3.0	2.3087	X	X		X
3	98.2	97.6	3.0	2.3121	X	X	X	
3	98.1	97.5	3.5	2.3766	X		X	X
3	97.3	96.4	7.3	2.8638		X	X	X
4	98.2	97.4	5.0	2.4460	X	X	X	X

Figure 10.7 Computer output (Minitab) for Furnival and Wilson all-possible-regression algorithm.

10.2.2 Stepwise Regression Methods

Because evaluating all possible regressions can be burdensome computationally, various methods have been developed for evaluating only a small number of subset regression models by either adding or deleting regressors one at a time. These

methods are generally referred to as **stepwise-type procedures**. They can be classified into three broad categories: (1) **forward selection**, (2) **backward elimination**, and (3) **stepwise regression**, which is a popular combination of procedures 1 and 2. We now briefly describe and illustrate these procedures.

Forward Selection This procedure begins with the assumption that there are **no regressors in the model** other than the intercept. An effort is made to find an optimal subset by inserting regressors into the model one at a time. The first regressor selected for entry into the equation is the one that has the **largest simple correlation** with the response variable y . Suppose that this regressor is x_1 . This is also the regressor that will produce the largest value of the F statistic for testing significance of regression. This regressor is entered if the F statistic exceeds a preselected F value, say F_{IN} (or F -to-enter). The second regressor chosen for entry is the one that now has the largest correlation with y after adjusting for the effect of the first regressor entered (x_1) on y . We refer to these correlations as **partial correlations**. They are the simple correlations between the residuals from the regression $\hat{y} = \hat{\beta}_0 + \hat{\beta}_1 x_1$ and the residuals from the regressions of the other candidate regressors on x_1 , say $\hat{x}_j = \hat{\alpha}_{0j} + \hat{\alpha}_{1j} x_1, j = 2, 3, \dots, K$.

Suppose that at step 2 the regressor with the highest partial correlation with y is x_2 . This implies that the largest partial F statistic is

$$F = \frac{SS_R(x_2|x_1)}{MS_{Res}(x_1, x_2)}$$

If this F value exceeds F_{IN} , then x_2 is added to the model. In general, at each step the regressor having the highest partial correlation with y (or equivalently the largest partial F statistic given the other regressors already in the model) is added to the model if its partial F statistic exceeds the preselected entry level F_{IN} . The procedure terminates either when the partial F statistic at a particular step does not exceed F_{IN} or when the last candidate regressor is added to the model.

Some computer packages report t statistics for entering or removing variables. This is a perfectly acceptable variation of the procedures we have described, because $t_{\alpha/2, v}^2 = F_{\alpha, 1, v}$.

We illustrate the stepwise procedure in Minitab. SAS and the R function `stepAIC()` in the `mass` directory also perform this procedure.

Example 10.2 Forward Selection—Hald Cement Data

We will apply the forward selection procedure to the Hald cement data given in Example 10.1. Figure 10.8 shows the results obtained when a particular computer program, the Minitab forward selection algorithm, was applied to these data. In this program the user specifies the cutoff value for entering variables by choosing a type I error rate α . Furthermore, Minitab uses the t statistics for decision making regarding variable selection, so the variable with the largest partial correlation with y is added to the model if $|t| > t_{\alpha/2}$. In this example we will use $\alpha = 0.25$, the default value in Minitab.

Stepwise Regression: y versus x1, x2, x3, x4

Forward selection. Alpha-to-enter: 0.25

Response is y on 4 predictors, with N=13

Step	1	2	3
Constant	117.57	103.10	71.65
x4	-0.738	-0.614	-0.237
T-Value	-4.77	-12.62	-1.37
P-Value	0.001	0.000	0.205
x1		1.44	1.45
T-value		10.40	12.41
P-Value		0.000	0.000
x2			0.42
T-Value			2.24
R-Value			0.052
S	8.96	2.73	2.31
R-Sq	67.45	97.25	98.23
R-Sq(adj)	64.50	96.70	97.64
Mallows C-p	138.7	5.5	3.0

Figure 10.8 Forward selection results from Minitab for the Hald cement data.

From Table 10.3, we see that the regressor most highly correlated with y is x_4 ($r_{4y} = -0.821$), and since the t statistic associated with the model using x_4 is $t = 4.77$ and $t_{0.25/2,11} = 1.21$, x_4 is added to the equation. At step 2 the regressor having the largest partial correlation with y (or the largest t statistic given that x_4 is in the model) is x_1 , and since the partial F statistic for this regressor is $t = 10.40$, which exceeds $t_{0.25/2,10} = 1.22$, x_1 is added to the model. In the third step, x_2 exhibits the highest partial correlation with y . The t statistic associated with this variable is 2.24, which is larger than $t_{0.25/2,9} = 1.23$, and so x_2 is added to the model. At this point the only remaining candidate regressor is x_3 , for which the t statistic does not exceed the cutoff value $t_{0.25/2,8} = 1.24$, so the forward selection procedure terminates with

$$\hat{y} = 71.6483 + 1.4519x_1 + 0.4161x_2 - 0.2365x_4$$

as the final model. ■

Backward Elimination Forward selection begins with **no regressors in the model** and attempts to insert variables until a suitable model is obtained. **Backward elimination** attempts to find a good model by working in the opposite direction. That is, we begin with a model that includes all K candidate regressors. Then the partial F statistic (or equivalently, a t statistic) is computed for each regressor as if it were the last variable to enter the model. The smallest of these partial F (or t) statistics

is compared with a preselected value, F_{OUT} (or t_{OUT}), for example, and if the smallest partial F (or t), value is less than F_{OUT} (or t_{OUT}), that regressor is removed from the model. Now a regression model with $K - 1$ regressors is fit, the partial F (or t) statistics for this new model calculated, and the procedure repeated. The backward elimination algorithm terminates when the smallest partial F (or t) value is not less than the preselected cutoff value F_{OUT} (or t_{OUT}).

Backward elimination is often a very good variable selection procedure. It is particularly favored by analysts who like to see the effect of including all the candidate regressors, just so that nothing “obvious” will be missed.

Example 10.3 Backward Elimination—Hald Cement Data

We will illustrate backward elimination using the Hald cement data from Example 10.1. Figure 10.9 presents the results of using the Minitab version of backward elimination on those data. In this run we have selected the cutoff value by using $\alpha = 0.10$, the default in Minitab. Minitab uses the t statistic for removing variables; thus, a regressor is dropped if the absolute value of its t statistic is less than $t_{OUT} = t_{0.1/2, n-p}$. Step 1 shows the results of fitting the full model. The smallest t value is 0.14, and it is associated with x_3 . Thus, since $t = 0.14 < t_{OUT} = t_{0.10/2, 8} = 1.86$, x_3 is removed from the model. At step 2 in Figure 10.9, we see the results of fitting the

```

Stepwise Regression: y versus x1, x2, x3, x4
Backward elimination. Alpha-to-Remove: 0.1
Response is y on 4 predictors, with N=13
Step           1           2           3
Constant      62.41      71.65      52.58

x1            1.55       1.45       1.47
T- Value      2.08       12.41      12.10
P- Value      0.071      0.000      0.000

x2            0.510      0.416      0.662
T- Value      0.70       2.24       14.44
P- Value      0.501      0.052      0.000

x3            0.10       0.14
T- Value      0.14
P- Value      0.896

x4           -0.14      -0.24
T- Value     -0.20      -1.37
P- Value      0.844      0.205

S             2.45       2.31       2.41
R- Sq        98.24      98.23      97.87
R- Sq(adj)   97.36      97.64      97.44
Mallows C-p   5.0        3.0        2.7
    
```

Figure 10.9 Backward selection results from Minitab for the Hald cement data.

three-variable model involving (x_1, x_2, x_4) . The smallest $t_{\text{statistic}}$ in this model, $t = -1.37$, is associated with x_4 . Since $|t| = 1.37 < t_{\text{OUT}} = t_{0.20/2,9} = 1.83$, x_4 is removed from the model. At step 3, we see the results of fitting the two-variable model involving (x_1, x_2) . The smallest t statistic in this model is 12.41, associated with x_1 , and since this exceeds $t_{\text{OUT}} = t_{0.10/2,10} = 1.81$, no further regressors can be removed from the model. Therefore, backward elimination terminates, yielding the final model

$$\hat{y} = 52.5773 + 1.4683x_1 + 0.6623x_2$$

Note that this is a different model from that found by forward selection. Furthermore, it is the model tentatively identified as best by the all-possible-regressions procedure. ■

Stepwise Regression The two procedures described above suggest a number of possible combinations. One of the most popular is the **stepwise regression algorithm** of Efron [1960]. Stepwise regression is a modification of forward selection in which at each step all regressors entered into the model previously are reassessed via their partial F (or t) statistics. A regressor added at an earlier step may now be redundant because of the relationships between it and regressors now in the equation. If the partial F (or t) statistic for a variable is less than F_{OUT} (or t_{OUT}), that variable is dropped from the model.

Stepwise regression requires two cutoff values, one for entering variables and one for removing them. Some analysts prefer to choose F_{IN} (or $t_{\text{IN}} = F_{\text{OUT}}$ (or t_{OUT}), although this is not necessary. Frequently we choose F_{IN} (or $t_{\text{IN}}) > F_{\text{OUT}}$ (or t_{OUT}), making it relatively more difficult to add a regressor than to delete one.

Example 10.4 Stepwise Regression—Hald Cement Data

Figure 10.10 presents the results of using the Minitab stepwise regression algorithm on the Hald cement data. We have specified the α level for either adding or removing a regressor as 0.15. At step 1, the procedure begins with no variables in the model and tries to add x_4 . Since the t statistic at this step exceeds $t_{\text{IN}} = t_{0.15/2,11} = 1.55$, x_4 is added to the model. At step 2, x_1 is added to the model. If the t statistic value for x_4 is less than $t_{\text{OUT}} = t_{0.15/2,10} = 1.56$, x_4 would be deleted. However, the t value for x_4 at step 2 is -12.62 , so x_4 is retained. In step 3, the stepwise regression algorithm adds x_2 to the model. Then the t statistics for x_1 and x_4 are compared to $t_{\text{OUT}} = t_{0.15/2,9} = 1.57$. Since for x_4 we find a t value of -1.37 , and since $|t| = 1.37$ is less than $t_{\text{OUT}} = 1.57$, x_4 is deleted. Step 4 shows the results of removing x_4 from the model. At this point the only remaining candidate regressor is x_3 , which cannot be added because its t value does not exceed t_{IN} . Therefore, stepwise regression terminates with the model

$$\hat{y} = 52.5773 + 1.4683x_1 + 0.6623x_2$$

This is the same equation identified by the all-possible-regressions and backward elimination procedures. ■

Stepwise Regression: y versus x1, x2, x3, x4
 Alpha-to-Enter: 0.15 Alpha-to-Remove: 0.15
 Response is y on 4 predictors, with N=13

Step	1	2	3	4
Constant	117.57	103.10	71.65	52.58
x4	-0.738	-0.614	-0.237	
T- Value	-4.77	-12.62	-1.37	
P- Value	0.001	0.000	0.205	
x1		1.44	1.45	1.47
T- Value		10.40	12.41	12.10
P- Value		0.000	0.000	0.000
x2			0.416	0.662
T- Value			2.24	14.44
P- Value			0.052	0.000
S	8.96	2.73	2.31	2.41
R- Sq	67.45	97.25	98.23	97.87
R- Sq (adj)	64.50	96.70	97.64	97.44
Mallows C- p	138.7	5.5	3.0	2.7

Figure 10.10 Stepwise selection results from Minitab for the Hald cement data.

General Comments on Stepwise-Type Procedures The stepwise regression algorithms described above have been criticized on various grounds, the most common being that none of the procedures generally guarantees that the best subset regression model of any size will be identified. Furthermore, since all the stepwise-type procedures terminate with one final equation, inexperienced analysts may conclude that they have found a model that is in some sense optimal. Part of the problem is that it is likely, not that there is one best subset model, but that there are several equally good ones.

The analyst should also keep in mind that the order in which the regressors enter or leave the model does not necessarily imply an order of importance to the regressors. It is not unusual to find that a regressor inserted into the model early in the procedure becomes negligible at a subsequent step. This is evident in the Hald cement data, for which forward selection chooses x_4 as the first regressor to enter. However, when x_2 is added at a subsequent step, x_4 is no longer required because of the high intercorrelation between x_2 and x_4 . This is in fact a **general** problem with the forward selection procedure. Once a regressor has been added, it cannot be removed at a later step.

Note that forward selection, backward elimination, and stepwise regression do not necessarily lead to the **same** choice of final model. The intercorrelation between the regressors affects the order of entry and removal. For example, using the Hald cement data, we found that the regressors selected by each procedure were as follows:

Forward selection	x_1	x_2	x_4
Backward elimination	x_1	x_2	
Stepwise regression	x_1	x_2	

Some users have recommended that all the procedures be applied in the hopes of either seeing some agreement or learning something about the structure of the data that might be overlooked by using only one selection procedure. Furthermore, there is not necessarily any agreement between any of the stepwise-type procedures and all possible regressions. However, Berk [1978] has noted that forward selection tends to agree with all possible regressions for small subset sizes but not for large ones, while backward elimination tends to agree with all possible regressions for large subset sizes but not for small ones.

For these reasons stepwise-type variable selection procedures should be used with caution. Our own preference is for the stepwise regression algorithm followed by backward elimination. The backward elimination algorithm is often less adversely affected by the correlative structure of the regressors than is forward selection (see Mantel [1970]).

Stopping Rules for Stepwise Procedures Choosing the cutoff values F_{IN} (or t_{IN}) and/or F_{OUT} (or t_{OUT}) in stepwise-type procedures can be thought of as specifying a stopping rule for these algorithms. Some computer programs allow the analyst to specify these numbers directly, while others require the choice of a type 1 error rate α to generate the cutoff values. However, because the partial F (or t) value examined at each stage is the maximum of several correlated partial F (or t) variables, thinking of α as a level of significance or type 1 error rate is misleading. Several authors (e.g., Draper, Guttman, and Kanemasa [1971] and Pope and Webster [1972]) have investigated this problem, and little progress has been made toward either finding conditions under which the “advertised” level of significance on the t or F statistic is meaningful or developing the exact distribution of the F (or t)-to-enter and F (or t)-to-remove statistics.

Some users prefer to choose relatively small values of F_{IN} and F_{OUT} (or the equivalent t statistics) so that several additional regressors that would ordinarily be rejected by more conservative F values may be investigated. In the extreme we may choose F_{IN} and F_{OUT} so that all regressors are entered by forward selection or removed by backward elimination revealing one subset model of each size for $p = 2, 3, \dots, K + 1$. These subset models may then be evaluated by criteria such as C_p or MS_{Res} to determine the final model. We do not recommend this extreme strategy because the analyst may think that the subsets so determined are in some sense optimal when it is likely that the best subset model was overlooked. A very popular procedure is to set $F_{IN} = F_{OUT} = 4$, as this corresponds roughly to the upper 5% point of the F distribution. Still another possibility is to make several runs using different values for the cutoffs and observe the effect of the choice of criteria on the subsets obtained.

There have been several studies directed toward providing practical guidelines in the choice of stopping rules. Bendel and Afifi [1974] recommend $\alpha = 0.25$ for forward selection. These are the defaults in Minitab. This would typically result in a numerical value of F_{IN} of between 1.3 and 2. Kennedy and Bancroft [1971] also suggest $\alpha = 0.25$ for forward selection and recommend $\alpha = 0.10$ for backward elimi-

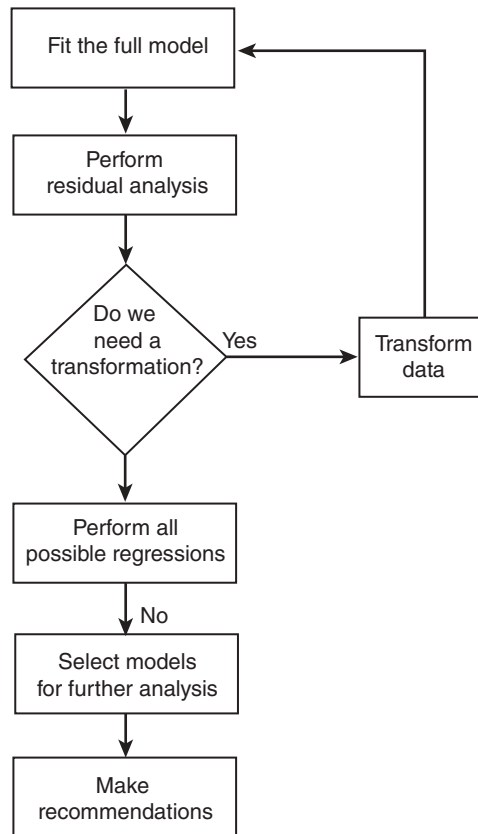

Figure 10.11 Flowchart of the model-building process.

nation. The choice of values for the cutoffs is largely a matter of the personal preference of the analyst, and considerable latitude is often taken in this area.

10.3 STRATEGY FOR VARIABLE SELECTION AND MODEL BUILDING

Figure 10.11 summarizes a basic approach for variable selection and model building. The basic steps are as follows:

1. Fit the largest model possible to the data.
2. Perform a thorough analysis of this model.
3. Determine if a transformation of the response or of some of the regressors is necessary.
4. Determine if all possible regressions are feasible.
 - If all possible regressions are feasible, perform all possible regressions using such criteria as Mallows's C_p , adjusted R^2 , and the PRESS statistic to rank the best subset models.

- If all possible regressions are not feasible, use stepwise selection techniques to generate the largest model such that all possible regressions are feasible. Perform all possible regressions as outlined above.
5. Compare and contrast the best models recommended by each criterion.
 6. Perform a thorough analysis of the “best” models (usually three to five models).
 7. Explore the need for further transformations.
 8. Discuss with the subject-matter experts the relative advantages and disadvantages of the final set of models.

By now, we believe that the reader has a good idea of how to perform a thorough analysis of the full model. The primary reason for analyzing the full model is to get some idea of the “big picture.” Important questions include the following:

- What regressors seem important?
- Are there possible outliers?
- Is there a need to transform the response?
- Do any of the regressors need transformations?

It is crucial for the analyst to recognize that there are two basic reasons why one may need a transformation of the response:

- The analyst is using the wrong “scale” for the purpose. A prime example of this situation is gas mileage data. Most people find it easier to interpret the response as “miles per gallon”; however, the data are actually measured as “gallons per mile.” For many engineering data, the proper scale involves a log transformation.
- There are significant outliers in the data, especially with regard to the fit by the full model. Outliers represent failures by the model to explain some of the responses. In some cases, the responses themselves are the problem, for example, when they are mismeasured at the time of data collection. In other cases, it is the model itself that creates the outlier. In these cases, dropping one of the unimportant regressors can actually clear up this problem.

We recommend the use of all possible regressions to identify subset models whenever it is feasible. With current computing power, all possible regressions is typically feasible for 20–30 candidate regressors, depending on the total size of the data set. It is important to keep in mind that all possible regressions suggests the best models purely in terms of whatever criteria the analyst chooses to use. Fortunately, there are several good criteria available, especially Mallows’s C_p , adjusted R^2 , and the PRESS statistic. In general, the PRESS statistic tends to recommend smaller models than Mallows’s C_p , which in turn tends to recommend smaller models than the adjusted R^2 . The analyst needs to reflect on the differences in the models in light of each criterion used. All possible regressions inherently leads to the recommendation of several candidate models, which better allows the subject-matter expert to bring his or her knowledge to bear on the problem. Unfortunately, not all statistical software packages support the all-possible-regressions approach.

The stepwise methods are fast, easy to implement, and readily available in many software packages. Unfortunately, these methods do not recommend subset models that are necessarily best with respect to any standard criterion. Furthermore, these methods, by their very nature, recommend a single, final equation that the unsophisticated user may incorrectly conclude is in some sense optimal.

We recommend a **two-stage strategy** when the number of candidate regressors is too large to employ the all-possible-regressions approach initially. The first stage uses stepwise methods to “screen” the candidate regressors, eliminating those that clearly have negligible effects. We then recommend using the all-possible-regressions approach to the reduced set of candidate regressors. The analyst should always use knowledge of the problem environment and common sense in evaluating candidate regressors. When confronted with a large list of candidate regressors, it is usually profitable to invest in some serious thinking before resorting to the computer. Often, we find that we can eliminate some regressors on the basis of logic or engineering sense.

A proper application of the all-possible-regressions approach should produce several (three to five) final candidate models. At this point, it is critical to perform thorough residual and other diagnostic analyses of each of these final models. In making the final evaluation of these models, we strongly suggest that the analyst ask the following questions:

1. Are the usual diagnostic checks for model adequacy satisfactory? For example, do the residual plots indicate unexplained structure or outliers or are there one or more high leverage points that may be controlling the fit? Do these plots suggest other possible transformation of the response or of some of the regressors?
2. Which equations appear most reasonable? Do the regressors in the best model make sense in light of the problem environment? Which models make the most sense from the subject-matter theory?
3. Which models are most usable for the intended purpose? For example, a model intended for prediction that contains a regressor that is unobservable at the time the prediction needs to be made is unusable. Another example is a model that includes a regressor whose cost of collecting is prohibitive.
4. Are the regression coefficients reasonable? In particular, are the signs and magnitudes of the coefficients realistic and the standard errors relatively small?
5. Is there still a problem with multicollinearity?

If these four questions are taken seriously and the answers strictly applied, in some (perhaps many) instances there will be no final satisfactory regression equation. For example, variable selection methods do not guarantee correcting all problems with multicollinearity and influence. Often, they do; however, there are situations where highly related regressors still make significant contributions to the model even though they are related. There are certain data points that always seem to be problematic.

The analyst needs to evaluate all the trade-offs in making recommendations about the final model. Clearly, judgment and experience in the model's intended operation environment must guide the analyst as he/she makes decisions about the final recommended model.

Finally, some models that fit the data upon which they were developed very well may not predict new observations well. We recommend that the analyst assess the **predictive ability** of models by observing their performance on new data not used to build the model. If new data are not readily available, then the analyst should set aside some of the originally collected data (if practical) for this purpose. We discuss these issues in more detail in Chapter 11.

10.4 CASE STUDY: GORMAN AND TOMAN ASPHALT DATA USING SAS

Gorman and Toman (1966) present data concerning the rut depth of 31 asphalt pavements prepared under different conditions specified by five regressors. A sixth regressor is used as an indicator variable to separate the data into two sets of runs. The variables are as follows: y is the rut depth per million wheel passes, x_1 is the viscosity of the asphalt, x_2 is the percentage of asphalt in the surface course, x_3 is the percentage of asphalt in the base course, x_4 is the run, x_5 is the percentage of fines in the surface course, and x_6 is the percentage of voids in the surface course. It was decided to use the log of the viscosity as the regressor, instead of the actual viscosity, based upon consultation with a civil engineer familiar with this material. Viscosity is an example of a measurement that is usually more nearly linear when expressed on a log scale.

The run regressor is actually an indicator variable. In regression model building, indicator variables can often present unique challenges. In many cases the relationships between the response and the other regressors change depending on the specific level of the indicator. Readers familiar with experimental design will recognize the concept of **interaction** between the indicator variable and at least some of the other regressors. This interaction complicates the model-building process, the interpretation of the model, and the prediction of new (future) observations. In some cases, the variance of the response is very different at the different levels of the indicator variable, which further complicates model building and prediction.

An example helps us to see the possible complications brought about by an indicator variable. Consider a multinational wine-making firm that makes Cabernet Sauvignon in Australia, California, and France. This company wishes to model the quality of the wine as measured by its professional tasting staff according to the standard 100-point scale. Clearly, local soil and microclimate as well as the processing variables impact the taste of the wine. Some potential regressors, such as the age of the oak barrels used to age the wine, may behave similarly from region to region. Other possible regressors, such as the yeast used in the fermentation process, may behave radically differently across the regions. Consequently, there may be considerable variability in the ratings for the wines made from the three regions, and it may be quite difficult to find a single regression model that describes wine quality incorporating the indicator variables to model the three regions. This model would

TABLE 10.5 Gorman and Toman Asphalt Data

Observation, i	y_i	x_{i1}	x_{i2}	x_{i3}	x_{i4}	x_{i5}	x_{i6}
1	6.75	2.80	4.68	4.87	0	8.4	4.916
2	13.00	1.40	5.19	4.50	0	6.5	4.563
3	14.75	1.40	4.82	4.73	0	7.9	5.321
4	12.60	3.30	4.85	4.76	0	8.3	4.865
5	8.25	1.70	4.86	4.95	0	8.4	3.776
6	10.67	2.90	5.16	4.45	0	7.4	4.397
7	7.28	3.70	4.82	5.05	0	6.8	4.867
8	12.67	1.70	4.86	4.70	0	8.6	4.828
9	12.58	0.92	4.78	4.84	0	6.7	4.865
10	20.60	0.68	5.16	4.76	0	7.7	4.034
11	3.58	6.00	4.57	4.82	0	7.4	5.450
12	7.00	4.30	4.61	4.65	0	6.7	4.853
13	26.20	0.60	5.07	5.10	0	7.5	4.257
14	11.67	1.80	4.66	5.09	0	8.2	5.144
15	7.67	6.00	5.42	4.41	0	5.8	3.718
16	12.25	4.40	5.01	4.74	0	7.1	4.715
17	0.76	88.00	4.97	4.66	1	6.5	4.625
18	1.35	62.00	4.01	4.72	1	8.0	4.977
19	1.44	50.00	4.96	4.90	1	6.8	4.322
20	1.60	58.00	5.20	4.70	1	8.2	5.087
21	1.10	90.00	4.80	4.60	1	6.6	5.971
22	0.85	66.00	4.98	4.69	1	6.4	4.647
23	1.20	140.00	5.35	4.76	1	7.3	5.115
24	0.56	240.00	5.04	4.80	1	7.8	5.939
25	0.72	420.00	4.80	4.80	1	7.4	5.916
26	0.47	500.00	4.83	4.60	1	6.7	5.471
27	0.33	180.00	4.66	4.72	1	7.2	4.602
28	0.26	270.00	4.67	4.50	1	6.3	5.043
29	0.76	170.00	4.72	4.70	1	6.8	5.075
30	0.80	98.00	5.00	5.07	1	7.2	4.334
31	2.00	35.00	4.70	4.80	1	7.7	5.705

also be of minimal value in predicting wine quality for a Cabernet Sauvignon produced from grapes grown in Oregon. In some cases, the best thing to do is to build separate models for each level of the indicator variable.

Table 10.5 gives the asphalt data. Table 10.6 gives the appropriate SAS code to perform the initial analysis of the data. Table 10.7 gives the resulting SAS output. Figures 10.12–10.19 give the residual plots from Minitab.

We note that the overall F test indicates that at least one regressor is important. The R^2 is 0.8060, which is good. The t tests on the individual coefficients indicate that only the log of the viscosity is important, which we will see later is misleading. The variance inflation factors indicate problems with log-visc and run. Figure 10.13 is the plot of the residuals versus the predicted values and indicates a major problem. This plot is consistent with the need for a log transformation of the response. We see a similar problem with Figure 10.14, which is the plot of the residuals versus the log of the viscosity. This plot is also interesting because it suggests that there may

TABLE 10.6 Initial SAS Code for Untransformed Response

```

data asphalt;
input rut_depth viscosity surface base run fines voids;
log_visc = log(viscosity);
cards;
  6.75      2.80    4.68    4.87    0    8.4    4.916
13.00      1.40    5.19    4.50    0    6.5    4.563
14.75      1.40    4.82    4.73    0    7.9    5.321
12.60      3.30    4.85    4.76    0    8.3    4.865
  8.25      1.70    4.86    4.95    0    8.4    3.776
10.67      2.90    5.16    4.45    0    7.4    4.397
  7.28      3.70    4.82    5.05    0    6.8    4.867
12.67      1.70    4.86    4.70    0    8.6    4.828
12.58      0.92    4.78    4.84    0    6.7    4.865
20.60      0.68    5.16    4.76    0    7.7    4.034
  3.58      6.00    4.57    4.82    0    7.4    5.450
  7.00      4.30    4.61    4.65    0    6.7    4.853
26.20      0.60    5.07    5.10    0    7.5    4.257
11.67      1.80    4.66    5.09    0    8.2    5.144
  7.67      6.00    5.42    4.41    0    5.8    3.718
12.25      4.40    5.01    4.74    0    7.1    4.715
  0.76     88.00    4.97    4.66    1    6.5    4.625
  1.35     62.00    4.01    4.72    1    8.0    4.977
  1.44     50.00    4.96    4.90    1    6.8    4.322
  1.60     58.00    5.20    4.70    1    8.2    5.087
  1.10     90.00    4.80    4.60    1    6.6    5.971
  0.85     66.00    4.98    4.69    1    6.4    4.647
  1.20    140.00    5.35    4.76    1    7.3    5.115
  0.56    240.00    5.04    4.80    1    7.8    5.939
  0.72    420.00    4.80    4.80    1    7.4    5.916
  0.47    500.00    4.83    4.60    1    6.7    5.471
  0.33    180.00    4.66    4.72    1    7.2    4.602
  0.26    270.00    4.67    4.50    1    6.3    5.043
  0.76    170.00    4.72    4.70    1    6.8    5.075
  0.80     98.00    5.00    5.07    1    7.2    4.334
  2.00     35.00    4.70    4.80    1    7.7    5.705
proc reg;
  model rut_depth = log_visc surface base run fines voids / vif;
  plot rstudent.*(predicted. log_visc surface base run fines voids);
  plot npp.*rstudent.;
run;

```

be two distinct models: one for the low viscosity and another for the high viscosity. This point is reemphasized in Figure 10.17, which is the residuals versus run plot. It looks like the first run (run 0) involved all the low-viscosity material while the second run (run 1) involved the high-viscosity material.

The plot of residuals versus run reveals a distinct difference in the variability between these two runs. We leave the exploration of this issue as an exercise. The residual plots also indicate one possible outlier.

TABLE 10.7 SAS Output for Initial Analysis of Asphalt Data

The REG Procedure

Model: MODEL1
Dependent Variable: rut_depth

Number of Observations Read	31
Number of Observations Used	31

Analysis of Variance

Source	DF	Sum of Squares	Mean Square	F Value	Pr > F
Model	6	1101.41861	183.56977	16.62	<.0001
Error	24	265.09983	11.04583		
Corrected Total	30	1366.51844			

Root MSE	3.32353	R-Square	0.8060
Dependent Mean	6.50710	Adj R-Sq	0.7575
Coeff Var	51.07541		

Parameter Estimates

Variable	DF	Parameter Estimate	Standard Error	t Value	Pr > t	Variance Inflation
Intercept	1	-14.95916	25.28809	-0.59	0.5597	0
log_visc	1	-3.15151	0.91945	-3.43	0.0022	10.86965
surface	1	3.97057	2.49665	1.59	0.1248	1.23253
base	1	1.26314	3.97029	0.32	0.7531	1.33308
run	1	1.96548	3.64720	0.54	0.5949	9.32334
fines	1	0.11644	1.01239	0.12	0.9094	1.47906
voids	1	0.58926	1.32439	0.44	0.6604	1.59128

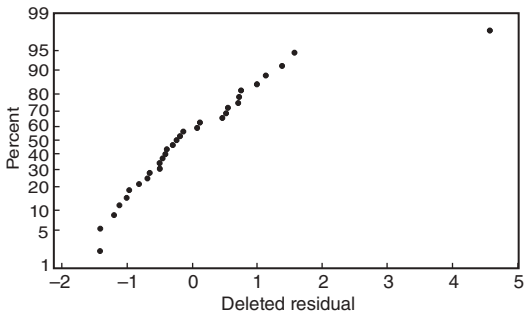

Figure 10.12 Normal probability plot of the residuals for the asphalt data.

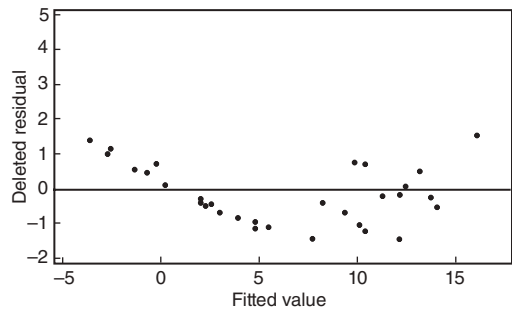

Figure 10.13 Residuals versus the fitted values for the asphalt data.

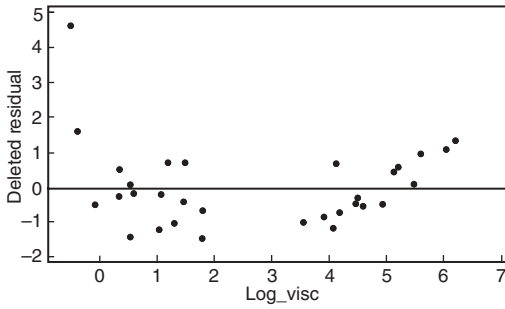

Figure 10.14 Residuals versus the log of the viscosity for the asphalt data.

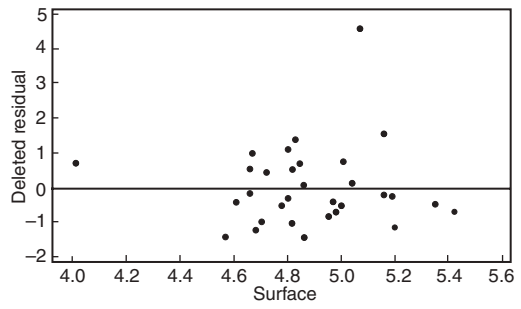

Figure 10.15 Residuals versus surface for the asphalt data.

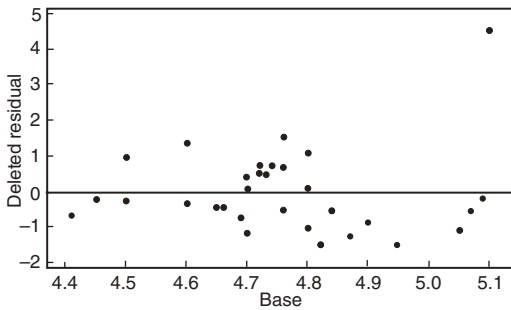

Figure 10.16 Residuals versus base for the asphalt data.

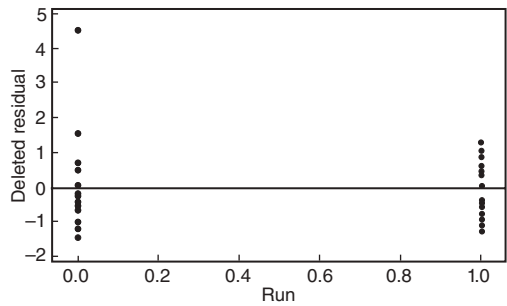

Figure 10.17 Residuals versus run for the asphalt data.

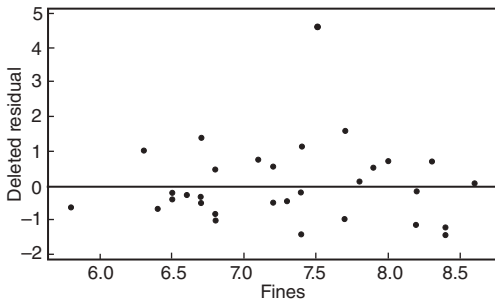

Figure 10.18 Residuals versus fines for the asphalt data.

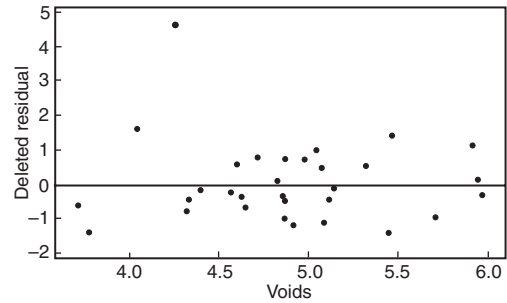

Figure 10.19 Residuals versus voids for the asphalt data.

TABLE 10.8 SAS Code for Analyzing Transformed Response Using Full Model

```

data asphalt;
input rut_depth viscosity surface base run fines voids;
log_rut = log(rut_depth);
log_visc = log(viscosity);
cards;
 6.75      2.80    4.68    4.87    0    8.4    4.916
13.00     1.40    5.19    4.50    0    6.5    4.563
14.75     1.40    4.82    4.73    0    7.9    5.321
12.60     3.30    4.85    4.76    0    8.3    4.865
 8.25     1.70    4.86    4.95    0    8.4    3.776
10.67     2.90    5.16    4.45    0    7.4    4.397
 7.28     3.70    4.82    5.05    0    6.8    4.867
12.67     1.70    4.86    4.70    0    8.6    4.828
12.58     0.92    4.78    4.84    0    6.7    4.865
20.60     0.68    5.16    4.76    0    7.7    4.034
 3.58     6.00    4.57    4.82    0    7.4    5.450
 7.00     4.30    4.61    4.65    0    6.7    4.853
26.20     0.60    5.07    5.10    0    7.5    4.257
11.67     1.80    4.66    5.09    0    8.2    5.144
 7.67     6.00    5.42    4.41    0    5.8    3.718
12.25     4.40    5.01    4.74    0    7.1    4.715
 0.76    88.00    4.97    4.66    1    6.5    4.625
 1.35    62.00    4.01    4.72    1    8.0    4.977
 1.44    50.00    4.96    4.90    1    6.8    4.322
 1.60    58.00    5.20    4.70    1    8.2    5.087
 1.10    90.00    4.80    4.60    1    6.6    5.971
 0.85    66.00    4.98    4.69    1    6.4    4.647
 1.20   140.00    5.35    4.76    1    7.3    5.115
 0.56   240.00    5.04    4.80    1    7.8    5.939
 0.72   420.00    4.80    4.80    1    7.4    5.916
 0.47   500.00    4.83    4.60    1    6.7    5.471
 0.33   180.00    4.66    4.72    1    7.2    4.602
 0.26   270.00    4.67    4.50    1    6.3    5.043
 0.76   170.00    4.72    4.70    1    6.8    5.075
 0.80    98.00    5.00    5.07    1    7.2    4.334
 2.00    35.00    4.70    4.80    1    7.7    5.705
proc reg;
  model log_rut = log_visc surface base run fines voids / vif;
  plot rstudent.*(predicted. log_visc surface base run fines
    voids);
  plot npp.*rstudent.;
run;

```

Table 10.8 gives the SAS code to generate the analysis on the log of the rut depth data. Table 10.9 gives the resulting SAS output.

Once again, the overall F test indicates that at least one regressor is important. The R^2 is very good. It is important to note that we cannot directly compare the R^2 from the untransformed response to the R^2 of the transformed response. However, the observed improvement in this case does support the use of the transformation. The t tests on the individual coefficients continue to suggest that the log of the

TABLE 10.9 SAS Output for Transformed Response and Full Model

The REG Procedure

Model: MODEL1
Dependent Variable: log_rut

Number of Observations Read	31
Number of Observations Used	31

Analysis of Variance

Source	DF	Sum of Squares	Mean Square	F Value	Pr > F
Model	6	56.34362	9.39060	98.47	<.0001
Error	24	2.28876	0.09537		
Corrected Total	30	58.63238			

Root MSE	0.30881	R-Square	0.9610
Dependent Mean	1.12251	Adj R-Sq	0.9512
Coeff Var	27.51101		

Parameter Estimates

Variable	DF	Parameter Estimate	Standard Error	t Value	Pr > t	Variance Inflation
Intercept	1	-1.23294	2.34970	-0.52	0.6046	10.86965
log_visc	1	-0.55769	0.8543	-6.53	<.0001	1.23253
surface	1	0.58358	0.23198	2.52	0.0190	1.33308
base	1	-0.10337	0.36891	-0.28	0.7817	9.32334
run	1	-0.34005	0.33889	-1.00	0.3257	1.47906
fines	1	0.09775	0.09407	1.04	0.3091	1.59128
voids	1	0.19885	0.12306	1.62	0.1192	

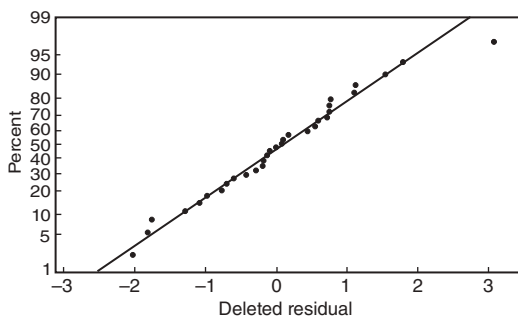

Figure 10.20 Normal probability plot of the residuals for the asphalt data after the log transformation.

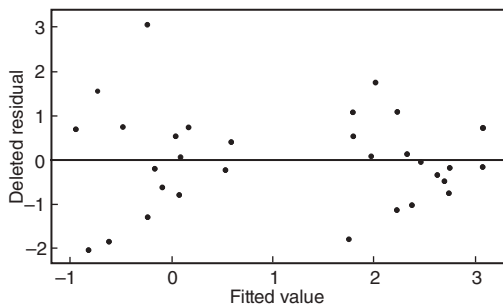

Figure 10.21 Residuals versus the fitted values for the asphalt data after the log transformation.

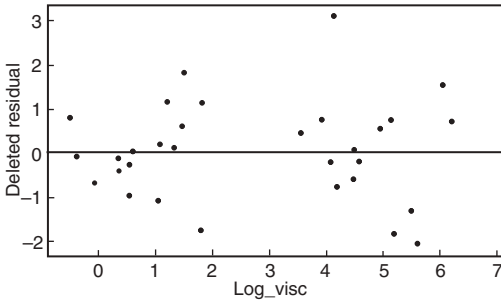

Figure 10.22 Residuals versus the log of the viscosity for the asphalt data after the log transformation.

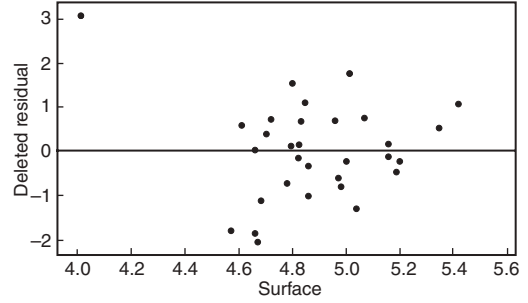

Figure 10.23 Residuals versus surface for the asphalt data after the log transformation.

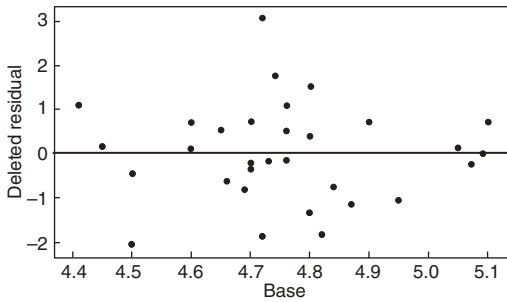

Figure 10.24 Residuals versus base for the asphalt data after the log transformation.

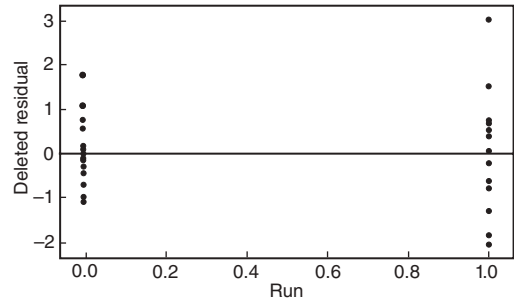

Figure 10.25 Residuals versus run for the asphalt data after the log transformation.

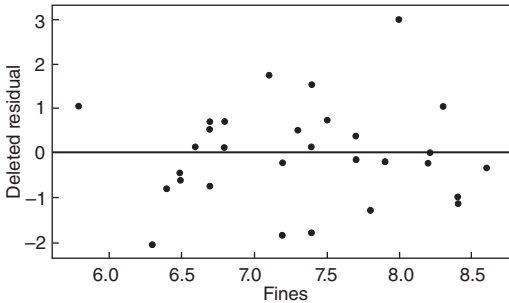

Figure 10.26 Residuals versus fines for the asphalt data after the log transformation.

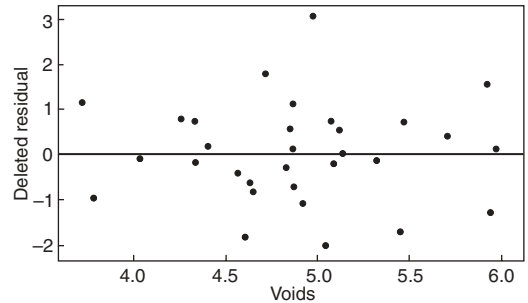

Figure 10.27 Residuals versus voids for the asphalt data after the log transformation.

viscosity is important. In addition, surface also looks important. The regressor voids appear marginal. There are no changes in the variance inflation factors because we only transformed the response, the variance inflation factors depend only on the relationships among the regressors.

Figures 10.20–10.27 give the residual plots. The plots of residual versus predicted value and residual versus individual regressor look much better, again supporting the value of the transformation. Interestingly, the normal probability plot of the

TABLE 10.10 SAS Code for All Possible Regressions of Asphalt Data

```

proc reg;

---

model log_rut = log_visc surface base
  run fines voids / selection= cp best = 10;
run;
proc reg;
model log_rut = log_visc surface base run
  fines voids / selection= adjrsq best = 10;
run;
proc reg;
model log_rut =log_visc surface base
  run fines voids / selection= forward;
run;
proc reg;
model log_rut = log_visc surface base
  run fines voids / selection= backward;
run;
proc reg;
model log_rut = log_visc surface base
  run fines voids / selection= stepwise;
run;

```

residuals actually looks a little worse. On the whole, we should feel comfortable using the log of the rut depth as the response. We shall restrict all further analysis to the transformed response.

Table 10.10 gives the SAS source code for the all-possible-regressions approach. Table 10.11 gives the annotated output.

Both the stepwise and backward selection techniques suggested the variables log of viscosity, surface, and voids. The forward selection techniques suggested the variables log of viscosity, surface, voids, run, and fines. Both of these models were in the top five models in terms of the C_p statistic.

We can obtain the PRESS statistic for a specific model by the following SAS model statement:

```
model log_rut=log_visc surface voids/p clm cli;
```

Table 10.12 summarizes the C_p , adjusted R^2 , and PRESS information for the best five models in terms of the C_p statistics. This table represents one of the very rare situations where a single model seems to dominate.

Table 10.13 gives the SAS code for analyzing the model that regresses log of rut depth against log of viscosity, surface, and voids. Table 10.14 gives the resulting SAS output. The overall F test is very strong. The R^2 is 0.9579, which is quite high. All three of the regressors are important. We see no problems with multicollinearity as evidenced by the variance inflation factors. The residual plots, which we do not show, all look good. Observation 18 has the largest hat diagonal, R -student, and $DFFITs$ value, which indicates that it is influential. The $DFBETAS$ suggest that this observation impacts the intercept and the surface regressor. On the whole, we should feel comfortable recommending this model.

TABLE 10.11 Annotated SAS Output for All Possible Regressions of Asphalt Data

The REG Procedure
 Model: MODEL1
 Dependent Variable: log_rut
 C(p) Selection Method

	Number of Observations Read	31	
	Number of Observations Used	31	

Number in Model	C(p)	R-Square	Variables in Model
3	2.9066	0.9579	log_visc surface voids
4	4.0849	0.9592	log_visc surface run voids
4	4.2564	0.9589	log_visc surface fines voids
4	4.8783	0.9579	log_visc surface base voids
5	5.0785	0.9608	log_visc surface run fines voids
2	5.2093	0.9509	log_visc surface
3	5.6161	0.9535	log_visc surface fines
4	5.7381	0.9565	log_visc surface run fines
3	5.8902	0.9530	log_visc surface run
5	6.0069	0.9593	log_visc surface base fines voids

The REG Procedure
 Model: MODEL1
 Dependent Variable: log_rut
 Adjusted R-Square Selection Method

	Number of Observations Read	31	
	Number of Observations Used	31	

Number in Model	Adjusted R-Square	R-Square	Variables in Model
3	0.9532	0.9579	log_visc surface voids
5	0.9530	0.9608	log_visc surface run fines voids
4	0.9529	0.9592	log_visc surface run voids
4	0.9526	0.9589	log_visc surface fines voids
4	0.9514	0.9579	log_visc surface base voids
6	0.9512	0.9610	log_visc surface base run fines voids
5	0.9512	0.9593	log_visc surface base fines voids
5	0.9510	0.9592	log_visc surface base run voids
4	0.9498	0.9565	log_visc surface run fines
3	0.9483	0.9535	log_visc surface fines

TABLE 10.12 Summary of the Best Models for Asphalt Data

Variables in Model							
log visc	surface	voids	run	finer	C_p	Adjusted R^2	PRESS
X	X	X			2.9	0.9532	3.75
X	X	X	X		4.1	0.9529	4.16
X	X	X		X	4.3	0.9526	3.91
X	X	X	X	X	4.9	0.9530	4.24
X	X				5.1	0.9474	3.66

TABLE 10.13 SAS Code for Recommended Model for Asphalt Data

```

data asphalt;
input rut_depth viscosity surface base run finer voids;
log_rut = log(rut_depth);
log_visc = log(viscosity);
cards;
 6.75    2.80    4.68    4.87    0    8.4    4.916
13.00    1.40    5.19    4.50    0    6.5    4.563
14.75    1.40    4.82    4.73    0    7.9    5.321
12.60    3.30    4.85    4.76    0    8.3    4.865
 8.25    1.70    4.86    4.95    0    8.4    3.776
10.67    2.90    5.16    4.45    0    7.4    4.397
 7.28    3.70    4.82    5.05    0    6.8    4.867
12.67    1.70    4.86    4.70    0    8.6    4.828
12.58    0.92    4.78    4.84    0    6.7    4.865
20.60    0.68    5.16    4.76    0    7.7    4.034
 3.58    6.00    4.57    4.82    0    7.4    5.450
 7.00    4.30    4.61    4.65    0    6.7    4.853
26.20    0.60    5.07    5.10    0    7.5    4.257
11.67    1.80    4.66    5.09    0    8.2    5.144
 7.67    6.00    5.42    4.41    0    5.8    3.718
12.25    4.40    5.01    4.74    0    7.1    4.715
 0.76   88.00    4.97    4.66    1    6.5    4.625
 1.35   62.00    4.01    4.72    1    8.0    4.977
 1.44   50.00    4.96    4.90    1    6.8    4.322
 1.60   58.00    5.20    4.70    1    8.2    5.087
 1.10   90.00    4.80    4.60    1    6.6    5.971
 0.85   66.00    4.98    4.69    1    6.4    4.647
 1.20  140.00    5.35    4.76    1    7.3    5.115
 0.56  240.00    5.04    4.80    1    7.8    5.939
 0.72  420.00    4.80    4.80    1    7.4    5.916
 0.47  500.00    4.83    4.60    1    6.7    5.471
 0.33  180.00    4.66    4.72    1    7.2    4.602
 0.26  270.00    4.67    4.50    1    6.3    5.043
 0.76  170.00    4.72    4.70    1    6.8    5.075
 0.80   98.00    5.00    5.07    1    7.2    4.334
 2.00   35.00    4.70    4.80    1    7.7    5.705
proc reg;
  model log_rut = log_visc surface voids/influence vif;
  plot rstudent.*(predicted. log_visc surface voids);
  plot npp.*rstudent.;
run;

```

TABLE 10.14 SAS Output for Analysis of Recommended Model

The REG Procedure											
Model: MODEL1											
Dependent Variable: log_rut											
Number of Observations Read 31											
Number of Observations Used 31											
Analysis of Variance											
Source	DF	Sum of Squares	Mean Square	F Value	Pr > F						
Model	3	56.16180	18.72060	204.59	<.0001						
Error	27	2.47059	0.09150								
Corrected Total	30	58.63238									
Root MSE	0.30250	R-Square	0.9579								
Dependent Mean	1.12251	Adj R-Sq	0.9532								
Coeff Var	26.94821										
Parameter Estimates											
Variable	DF	Parameter Estimate	Standard Error	t Value	Pr > t	Variance					
Intercept	1	-1.02079	1.36430	-0.75	0.4608	Inflation					
log_visc	1	-0.64649	0.02879	-22.46	<.0001	1.28617					
surface	1	0.55547	0.22044	2.52	0.0180	1.15993					
voids	1	0.24479	0.11560	2.12	0.0436	1.46344					
Dependent Variable: log_rut											
Output Statistics											
Obs	Residual	RStudent	Hat	Diag	Cov	Ratio	DFFITs	Intercept	DFBETAS		
1	-0.2070	-0.7058	0.0772	1.1681	-0.2041	log_visc	0.1167	surface	0.0960	voids	-0.0261
2	-0.1966	-0.6826	0.1114	1.2189	-0.2417	0.1182	0.1332	-0.1428	-0.0446		
3	-0.0503	-0.1764	0.1424	1.3495	-0.0719	0.0200	0.0574	-0.0056	-0.0489		

(Continued)

TABLE 10.14 (Continued)

4	0.4414	1.5366	0.0528	0.8671	0.3626	0.0080	-0.2230	-0.0230	0.0828
5	-0.1499	-0.5391	0.1778	1.3529	-0.2507	-0.1569	0.0084	0.0893	0.1975
6	0.1340	0.4559	0.0839	1.2297	0.1380	-0.0421	-0.0402	0.0710	-0.0196
7	-0.0170	-0.0567	0.0510	1.2248	-0.0131	-0.0016	0.0075	0.0021	-0.0024
8	0.0216	0.0729	0.0723	1.2526	0.0203	-0.0003	-0.0150	-0.0007	0.0053
9	-0.3471	-1.2241	0.1053	1.0388	-0.4199	-0.0402	0.3364	0.0760	-0.1167
10	-0.0570	-0.1993	0.1394	1.3431	-0.0802	0.0044	0.0341	-0.0232	0.0251
11	-0.4181	-1.5063	0.1185	0.9440	-0.4522	-0.0904	0.2813	0.2296	-0.2858
12	0.1610	0.5484	0.0827	1.2107	0.1646	0.1004	-0.0596	-0.1102	-0.0145
13	0.0980	0.3392	0.1177	1.2950	0.1239	-0.0066	-0.0744	0.0264	-0.0177
14	0.0101	0.0348	0.1125	1.3101	0.0124	0.0020	-0.0089	-0.0041	0.0051
15	0.2957	1.1257	0.2385	1.2625	0.6300	-0.1032	0.1201	0.3139	-0.3428
16	0.5471	1.9489	0.0496	0.7093	0.4453	-0.1210	-0.1883	0.1606	0.0472
17	-0.2519	-0.8659	0.0835	1.1325	-0.2614	-0.0360	-0.1884	-0.0208	0.1372
18	0.5433	2.6569	0.4405	0.7952	2.3574	2.1151	0.5423	-2.2282	-0.8813
19	0.1014	0.3489	0.1071	1.2783	0.1209	0.0421	0.0768	-0.0081	-0.0906
20	-0.0179	-0.0614	0.1100	1.3060	-0.0216	0.0157	-0.0051	-0.0166	-0.0066
21	-0.1027	-0.3638	0.1568	1.3515	-0.1569	0.0739	0.0072	-0.0317	-0.1260
22	-0.3369	-1.1632	0.0711	1.0220	-0.3218	-0.0272	-0.2132	-0.0420	0.1546
23	0.1740	0.6355	0.1992	1.3654	0.3169	-0.2377	0.1073	0.2581	0.0801
24	-0.2692	-1.0019	0.2108	1.2664	-0.5178	0.3663	-0.0799	-0.2768	-0.3662
25	0.4828	1.8173	0.1628	0.8610	0.8015	-0.2915	0.2740	0.1280	0.4568
26	0.2613	0.9190	0.1216	1.1651	0.3420	-0.0501	0.2267	0.0250	0.0588
27	-0.4457	-1.6629	0.1636	0.9281	-0.7354	-0.4870	-0.5330	0.3814	0.4930
28	-0.5355	-1.9830	0.1166	0.7494	-0.7204	-0.3287	-0.5361	0.3067	0.2484
29	0.2025	0.6930	0.0851	1.1814	0.2114	0.0768	0.1467	-0.0740	-0.0525
30	-0.0765	-0.2671	0.1348	1.3295	-0.1054	-0.0273	-0.0770	-0.0015	0.0746
31	0.005194	0.0178	0.1036	1.2973	0.0060	-0.0013	-0.0011	-0.0004	0.0044
			Sum of Residuals				0		
			Sum of Squared Residuals				2.47059		
			Predicted Residual SS (PRESS)				3.75152		

PROBLEMS

- 10.1** Consider the National Football League data in Table B.1.
- Use the forward selection algorithm to select a subset regression model.
 - Use the backward elimination algorithm to select a subset regression model.
 - Use stepwise regression to select a subset regression model.
 - Comment on the final model chosen by these three procedures.
- 10.2** Consider the National Football League data in Table B.1. Restricting your attention to regressors x_1 (rushing yards), x_2 (passing yards), x_4 (field goal percentage), x_7 (percent rushing), x_8 (opponents' rushing yards), and x_9 (opponents' passing yards), apply the all-possible-regressions procedure. Evaluate R_p^2 , C_p , and MS_{Res} for each model. Which subset of regressors do you recommend?
- 10.3** In stepwise regression, we specify that $F_{\text{IN}} \geq F_{\text{OUT}}$ (or $t_{\text{IN}} \geq t_{\text{OUT}}$). Justify this choice of cutoff values.
- 10.4** Consider the solar thermal energy test data in Table B.2.
- Use forward selection to specify a subset regression model.
 - Use backward elimination to specify a subset regression model.
 - Use stepwise regression to specify a subset regression model.
 - Apply all possible regressions to the data. Evaluate R_p^2 , C_p , and MS_{Res} for each model. Which subset model do you recommend?
 - Compare and contrast the models produced by the variable selection strategies in parts a–d.
- 10.5** Consider the gasoline mileage performance data in Table B.3.
- Use the all-possible-regressions approach to find an appropriate regression model.
 - Use stepwise regression to specify a subset regression model. Does this lead to the same model found in part a?
- 10.6** Consider the property valuation data found in Table B.4.
- Use the all-possible-regressions method to find the “best” set of regressors.
 - Use stepwise regression to select a subset regression model. Does this model agree with the one found in part a?
- 10.7** Use stepwise regression with $F_{\text{IN}} = F_{\text{OUT}} = 4.0$ to find the “best” set of regressor variables for the Belle Ayr liquefaction data in Table B.5. Repeat the analysis with $F_{\text{IN}} = F_{\text{OUT}} = 2.0$. Are there any substantial differences in the models obtained?
- 10.8** Use the all-possible-regressions method to select a subset regression model for the Belle Ayr liquefaction data in Table B.5. Evaluate the subset models using the C_p criterion. Justify your choice of final model using the standard checks for model adequacy.

- 10.9** Analyze the tube-flow reactor data in Table B.6 using all possible regressions. Evaluate the subset models using the R_p^2 , C_p , and MS_{Res} criteria. Justify your choice of final model using the standard checks for model adequacy.
- 10.10** Analyze the air pollution and mortality data in Table B.15 using all possible regressions. Evaluate the subset models using the R_p^2 , C_p , and MS_{Res} criteria. Justify your choice of the final model using the standard checks for model adequacy.
- Use the all-possible-regressions approach to find the best subset model for rut depth. Use C_p as the criterion.
 - Repeat part a using MS_{Res} as the criterion. Did you find the same model?
 - Use stepwise regression to find the best subset model. Did you find the same equation that you found in either part a or b above?
- 10.11** Consider the all-possible-regressions analysis of Hald's cement data in Example 10.1. If the objective is to develop a model to predict new observations, which equation would you recommend and why?
- 10.12** Consider the all-possible-regressions analysis of the National Football League data in Problem 10.2. Identify the subset regression models that are R^2 adequate (0.05).
- 10.13** Suppose that the full model is $y_i = \beta_0 + \beta_1 x_{i1} + \beta_2 x_{i2} + \varepsilon_i$, $i = 1, 2, \dots, n$, where x_{i1} and x_{i2} have been coded so that $S_{11} = S_{22} = 1$. We will also consider fitting a subset model, say $y_i = \beta_0 + \beta_1 x_{i1} + \varepsilon_i$.
- Let $\hat{\beta}_1^*$ be the least-squares estimate of β_1 from the full model. Show that $\text{Var}(\hat{\beta}_1^*) = \sigma^2 / (1 - r_{12}^2)$, where r_{12} is the correlation between x_1 and x_2 .
 - Let $\hat{\beta}_1$ be the least-squares estimate of β_1 from the subset model. Show that $\text{Var}(\hat{\beta}_1) = \sigma^2$. Is β_1 estimated more precisely from the subset model or from the full model?
 - Show that $E(\hat{\beta}_1) = \beta_1 + r_{12}\beta_2$. Under what circumstances is $\hat{\beta}_1$ an unbiased estimator of β_1 ?
 - Find the mean square error for the subset estimator $\hat{\beta}_1$. Compare $\text{MSE}(\hat{\beta}_1)$ with $\text{Var}(\hat{\beta}_1^*)$. Under what circumstances is $\hat{\beta}_1$ a preferable estimator, with respect to MSE?
- You may find it helpful to reread Section 10.1.2.
- 10.14** Table B.11 presents data on the quality of Pinot Noir wine.
- Build an appropriate regression model for quality y using the all-possible-regressions approach. Use C_p as the model selection criterion, and incorporate the region information by using indicator variables.
 - For the best two models in terms of C_p , investigate model adequacy by using residual plots. Is there any practical basis for selecting between these models?
 - Is there any difference between the two models in part b in terms of the PRESS statistic?

- 10.15** Use the wine quality data in Table B.11 to construct a regression model for quality using the stepwise regression approach. Compare this model to the one you found in Problem 10.4, part a.
- 10.16** Rework Problem 10.14, part a, but exclude the region information.
- Comment on the difference in the models you have found. Is there indication that the region information substantially improves the model?
 - Calculate confidence intervals as mean quality for all points in the data set using the models from part a of this problem and Problem 10.14, part a. Based on this analysis, which model would you prefer?
- 10.17** Table B.12 presents data on a heat treating process used to carburize gears. The thickness of the carburized layer is a critical factor in overall reliability of this component. The response variable $y = \text{PITCH}$ is the result of a carbon analysis on the gear pitch for a cross-sectioned part. Use all possible regressions and the C_p criterion to find an appropriate regression model for these data. Investigate model adequacy using residual plots.
- 10.18** Reconsider the heat treating data from Table B.12. Fit a model to the PITCH response using the variables

$$x_1 = \text{SOAKTIME} \times \text{SOAKPCT} \quad \text{and} \quad x_2 = \text{DIFFTIME} \times \text{DIFFPCT}$$

as regressors. How does this model compare to the one you found by the all-possible-regressions approach of Problem 10.17?

- 10.19** Repeat Problem 10.17 using the two cross-product variables defined in Problem 10.18 as additional candidate regressors. Comment on the model that you find.
- 10.20** Compare the models that you have found in Problems 10.17, 10.18, and 10.19 by calculating the confidence intervals on the mean of the response PITCH for all points in the original data set. Based on a comparison of these confidence intervals, which model would you prefer? Now calculate the PRESS statistic for these models. Which model would PRESS indicate is likely to be the best for predicting new observations on PITCH?
- 10.21** Table B.13 presents data on the thrust of a jet turbine engine and six candidate regressors. Use all possible regressions and the C_p criterion to find an appropriate regression model for these data. Investigate model adequacy using residual plots.
- 10.22** Reconsider the jet turbine engine thrust data in Table B.13. Use stepwise regression to find an appropriate regression model for these data. Investigate model adequacy using residual plots. Compare this model with the one found by the all-possible-regressions approach in Problem 10.21.
- 10.23** Compare the two best models that you have found in Problem 10.21 in terms of C_p by calculating the confidence intervals on the mean of the thrust response for all points in the original data set. Based on a comparison

of these confidence intervals, which model would you prefer? Now calculate the PRESS statistic for these models. Which model would PRESS indicate is likely to be the best for predicting new observations on thrust?

- 10.24** Table B.14 presents data on the transient points of an electronic inverter. Use all possible regressions and the C_p criterion to find an appropriate regression model for these data. Investigate model adequacy using residual plots.
- 10.25** Reconsider the electronic inverter data in Table B.14. Use stepwise regression to find an appropriate regression model for these data. Investigate model adequacy using residual plots. Compare this model with the one found by the all-possible-regressions approach in Problem 10.24.
- 10.26** Compare the two best models that you have found in Problem 10.24 in terms of C_p by calculating the confidence intervals on the mean of the response for all points in the original data set. Based on a comparison of these confidence intervals, which model would you prefer? Now calculate the PRESS statistic for these models. Which model would PRESS indicate is likely to be the best for predicting new response observations?
- 10.27** Reconsider the electronic inverter data in Table B.14. In Problems 10.24 and 10.25, you built regression models for the data using different variable selection algorithms. Suppose that you now learn that the second observation was incorrectly recorded and should be ignored.
- Fit a model to the modified data using all possible regressions, using C_p as the criterion. Compare this model to the model you found in Problem 10.24.
 - Use stepwise regression to find an appropriate model for the modified data. Compare this model to the one you found in Problem 10.25.
 - Calculate the confidence intervals as the mean response for all points in the modified data set. Compare these results with the confidence intervals from Problem 10.26. Discuss your findings.
- 10.28** Consider the electronic inverter data in Table B.14. Delete observation 2 from the original data. Electrical engineering theory suggests that we should define new variables as follows: $y^* = \ln y$, $x_1^* = 1/\sqrt{x_1}$, $x_2^* = \sqrt{x_2}$, $x_3^* = 1/\sqrt{x_3}$, and $x_4^* = \sqrt{x_4}$.
- Find an appropriate subset regression model for these data using all possible regressions and the C_p criterion.
 - Plot the residuals versus \hat{y}^* for this model. Comment on the plots.
 - Discuss how you could compare this model to the ones built using the original response and regressors in Problem 10.27.
- 10.29** Consider the Gorman and Toman asphalt data analyzed in Section 10.4. Recall that run is an indicator variable.
- Perform separate analyses of those data for run = 0 and run = 1.
 - Compare and contrast the results of the two analyses from part a.

- c. Compare and contrast the results of the two analyses from part a with the results of the analysis from Section 10.4.
- 10.30** Table B.15 presents data on air pollution and mortality. Use the all-possible-regressions selection on the air pollution data to find appropriate models for these data. Perform a thorough analysis of the best candidate models. Compare your results with stepwise regression. Thoroughly discuss your recommendations.
- 10.31** Use the all-possible-regressions selection on the patient satisfaction data in Table B.17. Perform a thorough analysis of the best candidate models. Compare your results with stepwise regression. Thoroughly discuss your recommendations.
- 10.32** Use the all-possible-regressions selection on the fuel consumption data in Table B.18. Perform a thorough analysis of the best candidate models. Compare your results with stepwise regression. Thoroughly discuss your recommendations.
- 10.33** Use the all-possible-regressions selection on the wine quality of young red wines data in Table B.19. Perform a thorough analysis of the best candidate models. Compare your results with stepwise regression. Thoroughly discuss your recommendations.
- 10.34** Use the all-possible-regressions selection on the methanol oxidation data in Table B.20. Perform a thorough analysis of the best candidate models. Compare your results with stepwise regression. Thoroughly discuss your recommendations.

CHAPTER 11

VALIDATION OF REGRESSION MODELS

11.1 INTRODUCTION

Regression models are used extensively for prediction or estimation, data description, parameter estimation, and control. Frequently the user of the regression model is a different individual from the model developer. Before the model is released to the user, some assessment of its **validity** should be made. We distinguish between **model adequacy checking** and **model validation**. Model adequacy checking includes residual analysis, testing for lack of fit, searching for high-leverage or overly influential observations, and other internal analyses that investigate the fit of the regression model to the available data. Model validation, however, is directed toward determining if the model will function successfully in its intended operating environment.

Since the fit of the model to the available data forms the basis for many of the techniques used in the model development process (such as variable selection), it is tempting to conclude that a model that fits the data well will also be successful in the final application. This is not necessarily so. For example, a model may have been developed primarily for predicting new observations. There is no assurance that the equation that provides the best fit to existing data will be a successful predictor. Influential factors that were unknown during the model-building stage may significantly affect the new observations, rendering the predictions almost useless. Furthermore, the correlative structure between the regressors may differ in the model-building and prediction data. This may result in poor predictive performance for the model. Proper validation of a model developed to predict new observations should involve testing the model in that environment before it is released to the user.

Introduction to Linear Regression Analysis, Fifth Edition. Douglas C. Montgomery, Elizabeth A. Peck, G. Geoffrey Vining.

© 2012 John Wiley & Sons, Inc. Published 2012 by John Wiley & Sons, Inc.

Another critical reason for validation is that the model developer often has little or no control over the model's final use. For example, a model may have been developed as an interpolation equation, but when the user discovers that it is successful in that respect, he or she will also extrapolate with it if the need arises, despite any warnings or cautions from the developer. Furthermore, if this extrapolation performs poorly, it is almost always the model **developer** and not the model **user** who is blamed for the failure. Regression model users will also frequently draw conclusions about the process being studied from the signs and magnitudes of the coefficients in their model, even though they have been cautioned about the hazards of interpreting partial regression coefficients. Model validation provides a measure of protection for both model developer and user.

Proper validation of a regression model should include a **study of the coefficients** to determine if their signs and magnitudes are reasonable. That is, can $\hat{\beta}_j$ be reasonably interpreted as an estimate of the effect of x_j ? We should also investigate the **stability** of the regression coefficients. That is, are the $\hat{\beta}_j$ obtained from a new sample likely to be similar to the current coefficients? Finally, validation requires that the model's **prediction performance** be investigated. Both interpolation and extrapolation modes should be considered.

This chapter will discuss and illustrate several techniques useful in validating regression models. Several references on the general subject of validation are Brown, Durbin, and Evans [1975], Geisser [1975], McCarthy [1976], Snee [1977], and Stone [1974]. Snee's paper is particularly recommended.

11.2 VALIDATION TECHNIQUES

Three types of procedures are useful for validating a regression model:

1. Analysis of the model coefficients and predicted values including comparisons with prior experience, physical theory, and other analytical models or simulation results
2. Collection of new (or fresh) data with which to investigate the model's predictive performance
3. Data splitting, that is, setting aside some of the original data and using these observations to investigate the model's predictive performance

The **final intended use** of the model often indicates the appropriate validation methodology. Thus, validation of a model intended for use as a predictive equation should concentrate on determining the model's prediction accuracy. However, because the developer often does not control the use of the model, we recommend that, whenever possible, all the validation techniques above be used. We will now discuss and illustrate these techniques. For some additional examples, see Snee [1977].

11.2.1 Analysis of Model Coefficients and Predicted Values

The coefficients in the final regression model should be studied to determine if they are **stable** and if their **signs and magnitudes** are reasonable. Previous experience, theoretical considerations, or an analytical model can often provide information

concerning the direction and relative size of the effects of the regressors. The coefficients in the estimated model should be compared with this information. Coefficients with unexpected signs or that are too large in absolute value often indicate either an inappropriate model (missing or misspecified regressors) or poor estimates of the effects of the individual regressors. The **variance inflation factors** and the other multicollinearity diagnostics in Chapter 19 also are an important guide to the validity of the model. If any VIF exceeds 5 or 10, that particular coefficient is poorly estimated or unstable because of near-linear dependences among the regressors. When the data are collected across time, we can examine the stability of the coefficients by fitting the model on shorter time spans. For example, if we had several years of monthly data, we could build a model for each year. Hopefully, the coefficients for each year would be similar.

The predicted response values \hat{y} can also provide a measure of model validity. Unrealistic predicted values such as negative predictions of a positive quantity or predictions that fall outside the anticipated range of the response, indicate poorly estimated coefficients or an incorrect model form. Predicted values inside and on the boundary of the regressor variable bull provide a measure of the model's **interpolation** performance. Predicted values outside this region are a measure of **extrapolation** performance.

Example 11.1 The Bald Cement Data

Consider the Hald cement data introduced in Example 10.1. We used all possible regressions to develop two possible models for these data, model 1,

$$\hat{y} = 52.58 + 1.468x_1 + 0.662x_2$$

and model 2,

$$\hat{y} = 71.65 + 1.452x_1 + 0.416x_2 - 0.237x_4$$

Note that the regression coefficient for x_1 is very similar in both models, although the intercepts are very different and the coefficients of x_2 are moderately different. In Table 10.5 we calculated the values of the PRESS statistic, $R_{\text{Prediction}}^2$, and the VIFs for both models. For model 1 both VIFs are very small, indicating no potential problems with multicollinearity. However, for model 2, the VIFs associated with x_2 and x_4 exceed 10, indicating that moderate problems with multicollinearity are present. Because multicollinearity often impacts the predictive performance of a regression model, a reasonable initial validation effort would be to examine the predicted values to see if anything unusual is apparent. Table 11.1 presents the predicted values corresponding to each individual observation for both models. The predicted values are virtually identical for both models, so there is little reason to believe that either model is inappropriate based on this test of prediction performance. However, this is only a relative simple test of model prediction performance, not a study of how either model would perform if moderate extrapolation were required. Based in this simple analysis of coefficients and predicted values, there is little reason to doubt the validity of either model, but as noted in Example 10.1, we would probably prefer model 1 because it has fewer parameters and smaller VIFs. ■

TABLE 11.1 Prediction Values for Two Models for Hald Cement Data

y	x_1	x_2	x_3	x_4	Model 1	Model 2
78.5	7	26	6	60	80.074	78.438
74.3	1	29	15	52	73.251	72.867
104.3	11	56	8	20	105.815	106.191
87.6	11	31	8	47	89.258	89.402
95.9	7	52	6	33	97.293	95.644
109.2	11	55	9	22	105.152	105.302
102.7	3	71	17	6	104.002	104.129
72.5	1	31	22	44	74.575	75.592
93.1	2	54	18	22	91.275	91.818
115.9	21	47	4	26	114.538	115.546
83.8	1	40	23	34	80.536	81.702
113.3	11	66	9	12	112.437	112.244
109.4	10	68	8	12	112.293	111.625

11.2.2 Collecting Fresh Data—Confirmation Runs

The most effective method of validating a regression model with respect to its prediction performance is to collect new data and directly compare the model predictions against them. If the model gives accurate predictions of new data, the user will have greater confidence in both the model and the model-building process. Sometimes these new observations are called **confirmation runs**. At least 15–20 new observations are desirable to give a reliable assessment of the model’s prediction performance. In situations where two or more alternative regression models have been developed from the data, comparing the prediction performance of these models on new data may provide a basis for final model selection.

Example 11.2 The Delivery Time Data

Consider the delivery time data introduced in Example 3.1. We have previously developed a least-squares fit for these data. The objective of fitting the regression model is to predict new observations. We will investigate the validity of the least-squares model by predicting the delivery time for fresh data.

Recall that the original 25 observations came from four cities: Austin, San Diego, Boston, and Minneapolis. Fifteen new observations from Austin, Boston, San Diego, and a fifth city, Louisville, are shown in Table 11.2, along with the corresponding predicted delivery times and prediction errors from the least-squares fit $\hat{y} = 2.3412 + 1.6159x_1 + 0.0144x_2$ (columns 5 and 6). Note that this prediction data set consists of 11 observations from cities used in the original data collection process and 4 observations from a new city. This mix of old and new cities may provide some information on how well the two models predict at sites where the original data were collected and at new sites.

Column 6 of Table 11.2 shows the prediction errors for the least-squares model. The average prediction error is 0.4060, which is nearly zero, so that model seems to produce approximately unbiased predictions. There is only one relatively large prediction error, associated with the last observation from Louisville. Checking the original data reveals that this observation is an extrapolation point. Furthermore,

TABLE 11.2 Prediction Data Set for the Delivery Time Example

	(1)	(2)	(3)	(4)	(5)	(6)
				Observed	Least-Squares Fit	
Observation	City	Cases, x_1	Distance, x_2	Time, y	\hat{y}	$y - \hat{y}$
26	San Diego	22	905	51.00	50.9230	0.0770
27	San Diego	7	520	16.80	21.1405	-4.3405
28	Boston	15	290	26.16	30.7557	-4.5957
29	Boston	5	500	19.90	17.6207	2.2793
30	Boston	6	1000	24.00	26.4366	-2.4366
31	Boston	6	225	18.55	15.2766	3.2734
32	Boston	10	775	31.93	29.6602	2.2698
33	Boston	4	212	16.95	11.8576	5.0924
34	Austin	1	144	7.00	6.0307	0.9693
35	Austin	3	126	14.00	9.0033	4.9967
36	Austin	12	655	37.03	31.1640	5.8660
37	Louisville	10	420	18.62	24.5482	-5.9282
38	Louisville	7	150	16.10	15.8125	0.2875
39	Louisville	8	360	24.38	20.4524	3.9276
40	Louisville	32	1530	64.75	76.0820	-11.3320

this point is quite similar to point 9, which we know to be influential. From an overall perspective, these prediction errors increase our confidence in the usefulness of the model. Note that the prediction errors are generally larger than the residuals from the least-squares fit. This is easily seen by comparing the residual mean square

$$MS_{\text{Res}} = 10.6239$$

from the fitted model and the average squared prediction error

$$\frac{\sum_{i=26}^{40} (y_i - \hat{y}_i)^2}{15} = \frac{332.2809}{15} = 22.1521$$

from the new prediction data. Since MS_{Res} (which may be thought of as the average variance of the residuals from the fit) is smaller than the average squared prediction error, the least-squares regression model does not predict new data as well as it fits the existing data. However, the degradation of performance is not severe, and so we conclude that the least-squares model is likely to be successful as a predictor. Note also that apart from the one extrapolation point the prediction errors from Louisville are not remarkably different from those experienced in the cities where the original data were collected. While the sample is small, this is an indication that the model may be portable. More extensive data collection at other sites would be helpful in verifying this conclusion.

It is also instructive to compare R^2 from the least-squares fit (0.9596) to the percentage of variability in the new data explained by the model, say

$$R_{\text{Prediction}}^2 = 1 - \frac{\sum_{i=26}^{40} (y_i - \hat{y}_i)^2}{\sum_{i=26}^{40} (y_i - \hat{y}_i)^2} = 1 - \frac{332.2809}{3206.2338} = 0.8964$$

Once again, we see that the least-squares model does not predict new observations as well as it fits the original data. However, the “loss” in R^2 for prediction is slight. ■

Collecting new data has indicated that the least-squares fit for the delivery time data results in a reasonably good prediction equation. The interpolation performance of the model is likely to be better than when the model is used for extrapolation.

11.2.3 Data Splitting

In many situations, collecting new data for validation purposes is not possible. The data collection budget may already have been spent, the plant may have been converted to the production of other products or other equipment and resources needed for data collection may be unavailable. When these situations occur, a reasonable procedure is to split the available data into two parts, which Snee [1977] calls the **estimation data** and the **prediction data**. The estimation data are used to build the regression model, and the prediction data are then used to study the predictive ability of the model. Sometimes data splitting is called **cross validation** (see Mosteller and Tukey [1968] and Stone [1974]).

Data splitting may be done in several ways. For example, the PRESS statistic

$$\text{PRESS} = \sum_{i=1}^n [y_i - \hat{y}_{(i)}]^2 = \sum_{i=1}^n \left(\frac{e_i}{1 - h_{ii}} \right)^2 \quad (11.1)$$

is a form of data splitting. Recall that PRESS can be used in computing the R^2 -like statistic

$$R_{\text{Prediction}}^2 = 1 - \frac{\text{PRESS}}{SS_T}$$

that measures in an approximate sense how much of the variability in new observations the model might be expected to explain. To illustrate, recall that in Chapter 4 (Example 4.6) we calculated PRESS for the model fit to the original 25 observations on delivery time and found that $\text{PRESS} = 457.4000$. Therefore,

$$R_{\text{Prediction}}^2 = 1 - \frac{\text{PRESS}}{SS_T} = 1 - \frac{457.4000}{5784.5426} = 0.9209$$

Now for the least-squares fit $R^2 = 0.9596$, so PRESS would indicate that the model is likely to be a very good predictor of new observations. Note that the R^2 for

prediction based on PRESS is very similar to the actual prediction performance observed for this model with new data in Example 11.2.

If the data are collected in a **time sequence**, then **time** may be used as the basis of data splitting. That is, a particular time period is identified, and all observations collected before this time period are used to form the estimation data set, while observations collected later than this time period form the prediction data set. Fitting the model to the estimation data and examining its prediction accuracy for the prediction data would be a reasonable validation procedure to determine how the model is likely to perform in the future. This type of validation procedure is relatively common practice in time series analysis for investigating the potential performance of a forecasting model (for some examples, see Montgomery, Johnson, and Gardiner [1990]). For examples involving regression models, see Cady and Allen [1972] and Draper and Smith [1998].

In addition to time, other characteristics of the data can often be used for data splitting. For example, consider the delivery time data from Example 3.1 and assume that we had the additional 15 observations in Table 11.2 also available. Since there are five cities represented in the sample, we could use the observations from San Diego, Boston, and Minneapolis (for example) as the estimation data and the observations from Austin and Louisville as the prediction data. This would give 29 observations for estimation and 11 observations for validation. In other problem situations, we may find that operators, batches of raw materials, units of test equipment, laboratories, and so forth, can be used to form the estimation and prediction data sets. In cases where no logical basis of data splitting exists, one could randomly assign observations to the estimation and prediction data sets. If random allocations are used, one could repeat the process several times so that different subsets of observations are used for model fitting.

A potential disadvantage to these somewhat **arbitrary** methods of data splitting is that there is often no assurance that the prediction data set “stresses” the model severely enough. For example, a **random division** of the data would not necessarily ensure that some of the points in the prediction data set are extrapolation points, and the validation effort would provide no information on how well the model is likely to extrapolate. Using several different randomly selected estimation—prediction data sets would help solve this potential problem. In the absence of an obvious basis for data splitting, in some situations it might be helpful to have a formal procedure for choosing the estimation and prediction data sets.

Snee [1977] describes the DUPLEX algorithm for data splitting. He credits the development of the procedure to R. W. Kennard and notes that it is similar to the CADEX algorithm that Kennard and Stone [1969] proposed for design construction. The procedure utilizes the distance between all pairs of observations in the data set. The algorithm begins with a list of the n observations where the k regressors are standardized to unit length, that is,

$$z_{ij} = \frac{x_{ij} - \bar{x}_j}{S_{jj}^{1/2}}, \quad i = 1, 2, \dots, n, \quad j = 1, 2, \dots, k$$

where $S_{jj} = \sum_{i=1}^n (x_{ij} - \bar{x}_j)^2$ is the corrected sum of squares of the j th regressor. The standardized regressors are then **orthonormalized**. This can be done by factoring the $\mathbf{Z}'\mathbf{Z}$ matrix as

$$\mathbf{Z}'\mathbf{Z} = \mathbf{T}'\mathbf{T} \tag{11.2}$$

where \mathbf{T} is a unique $k \times k$ upper triangular matrix. The elements of \mathbf{T} can be found using the square root or Cholesky method (see Graybill [1976, pp. 231–236]). Then make the transformation

$$\mathbf{W} = \mathbf{Z}\mathbf{T}^{-1} \tag{11.3}$$

resulting in a new set of variables (the w 's) that are orthogonal and have unit variance. This transformation makes the factor space more spherical.

Using the orthonormalized points, the Euclidean distance between all $\binom{n}{2}$ pairs of points is calculated. The pair of points that are the farthest apart is assigned to the estimation data set. This pair of points is removed from the list of points and the pair of remaining points that are the farthest apart is assigned to the prediction data set. Then this pair of points is removed from the list and the remaining point that is farthest from the pair of points in the estimation data set is included in the estimation data set. At the next step, the remaining unassigned point that is farthest from the two points in the prediction data set is added to the prediction data. The algorithm then continues to alternatively place the remaining points in either the estimation or prediction data sets until all n observations have been assigned.

Snee [1977] suggests measuring the statistical properties of the estimation and prediction data sets by comparing the p th root of the determinants of the $\mathbf{X}'\mathbf{X}$ matrices for these two data sets, where p is the number of parameters in the model. The determinant of $\mathbf{X}'\mathbf{X}$ is related to the volume of the region covered by the points. Thus, if \mathbf{X}_E and \mathbf{X}_P denote the \mathbf{X} matrices for points in the estimation and prediction data sets, respectively, then

$$\left(\frac{|\mathbf{X}'_E \mathbf{X}_E|}{|\mathbf{X}'_P \mathbf{X}_P|} \right)^{1/p}$$

is a measure of the relative volumes of the regions spanned by the two data sets. Ideally this ratio should be close to unity. It may also be useful to examine the variance inflation factors for the two data sets and the eigenvalue spectra of $\mathbf{X}'_E \mathbf{X}_E$ and $\mathbf{X}'_P \mathbf{X}_P$ to measure the relative correlation between the regressors.

In using any data-splitting procedure (including the DUPLEX algorithm), several points should be kept in mind:

1. Some data sets may be too small to effectively use data splitting. Snee [1977] suggests that at least $n \geq 2p + 25$ observations are required if the estimation and prediction data sets are of equal size, where p is the largest number of parameters likely to be required in the model. This sample size requirement ensures that there are a reasonable number of error degrees of freedom for the model.
2. Although the estimation and prediction data sets are often of equal size, one can split the data in any desired ratio. Typically the estimation data set would be larger than the prediction data set. Such splits are found by using the data-splitting procedure until the prediction data set contains the required number

of points and then placing the remaining unassigned points in the estimation data set. Remember that the prediction data set should contain at least 15 points in order to obtain a reasonable assessment of model performance.

3. Replicates or points that are near neighbors in x space should be eliminated before splitting the data. Unless these replicates are eliminated, the estimation and prediction data sets may be very similar, and this would not necessarily test the model severely enough. In an extreme case where every point is replicated twice, the DUPLEX algorithm would form the estimation data set with one replicate and the prediction data set with the other replicate. The near-neighbor algorithm described in Section 4.5.2 may also be helpful. Once a set of near neighbors is identified, the average of the x coordinates of these points should be used in the data-splitting procedure.
4. A potential **disadvantage** of data splitting is that it **reduces the precision** with which regression coefficients are estimated. That is, the standard errors of the regression coefficients obtained from the estimation data set will be larger than they would have been if all the data had been used to estimate the coefficients. In large data sets, the standard errors may be small enough that this loss in precision is unimportant. However, the percentage increase in the standard errors can be large. If the model developed from the estimation data set is a satisfactory predictor, one way to improve the precision of estimation is to reestimate the coefficients using the entire data set. The estimates of the coefficients in the two analyses should be very similar if the model is an adequate predictor of the prediction data set.
5. **Double-cross validation** may be useful in some problems. This is a procedure in which the data are first split into estimation and prediction data sets, a model developed from the estimation data, and its performance investigated using the prediction data. Then the roles of the two data sets are **reversed**; a model is developed using the **original prediction data**, and it is used to predict the **original estimation data**. The advantage of this procedure is that it provides two evaluations of model performance. The disadvantage is that there are now **three** models to choose from, the two developed via data splitting and the model fitted to all the data. If the model is a good predictor, it will make little difference which one is used, except that the standard errors of the coefficients in the model fitted to the total data set will be smaller. If there are major differences in predictive performance, coefficient estimates, or functional form for these models, then further analysis is necessary to discover the reasons for these differences.

Example 11.3 The Delivery Time Data

All 40 observations for the delivery time data in Examples 3.1 and 11.2 are shown in Table 11.3. We will assume that these 40 points were collected at one time and use the data set to illustrate data splitting with the DUPLEX algorithm. Since the model will have two regressors, an equal split of the data will give 17 error degrees of freedom for the estimation data. This is adequate, so DUPLEX can be used to generate the estimation and prediction data sets. An $x_1 - x_2$ plot is shown in Figure 11.1. Examination of the data reveals that there are two pairs of points that are near

TABLE 11.3 Delivery Time Data

Observation, <i>i</i>	Cases, x_1	Distance, x_2	Delivery Time, y	Estimation (<i>E</i>) or Prediction (<i>P</i>) Data Set
1	7	560	16.68	<i>P</i>
2	3	220	11.50	<i>P</i>
3	3	340	12.03	<i>P</i>
4	4	80	14.88	<i>E</i>
5	6	150	13.75	<i>E</i>
6	7	330	18.11	<i>E</i>
7	2	110	8.00	<i>E</i>
8	7	210	17.83	<i>E</i>
9	30	1460	79.24	<i>E</i>
10	5	605	21.50	<i>E</i>
11	16	688	40.33	<i>P</i>
12	10	215	21.00	<i>P</i>
13	4	255	13.50	<i>E</i>
14	6	462	19.75	<i>P</i>
15	9	448	24.00	<i>E</i>
16	10	776	29.00	<i>P</i>
17	6	200	15.35	<i>P</i>
18	7	132	19.00	<i>E</i>
19	3	36	9.50	<i>P</i>
20	17	770	35.10	<i>E</i>
21	10	140	17.90	<i>E</i>
22	26	810	52.32	<i>E</i>
23	9	450	18.75	<i>E</i>
24	8	635	19.83	<i>E</i>
25	4	150	10.75	<i>E</i>
26	22	905	51.00	<i>P</i>
27	7	520	16.80	<i>E</i>
28	15	290	26.16	<i>P</i>
29	5	500	19.90	<i>E</i>
30	6	1000	24.00	<i>E</i>
31	6	225	18.55	<i>E</i>
32	10	775	31.93	<i>P</i>
33	4	212	16.95	<i>P</i>
34	1	144	7.00	<i>P</i>
35	3	126	14.00	<i>P</i>
36	12	655	37.03	<i>P</i>
37	10	420	18.62	<i>P</i>
38	7	150	16.10	<i>P</i>
39	8	360	24.38	<i>P</i>
40	32	1530	64.75	<i>P</i>

neighbors in the x space, observations 15 and 23 and observations 16 and 32. These two clusters of points are circled in Figure 11.1. The $x_1 - x_2$ coordinates of these clusters of points are averaged and the list of points for use in the DUPLEX algorithm is shown in columns 1 and 2 of Table 11.4.

The standardized and orthonormalized data are shown in columns 3 and 4 of Table 11.4 and plotted in Figure 11.2. Notice that the region of coverage is more

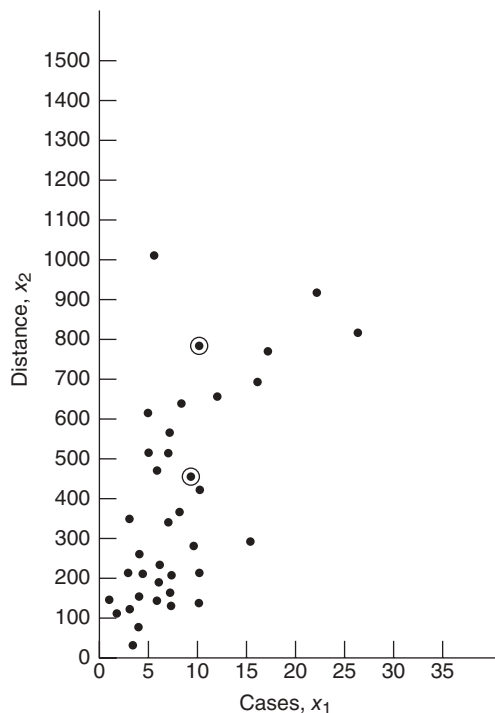

Figure 11.1 Scatterplot of delivery volume x_1 versus distance x_2 , Example 11.3.

spherical than in Figure 11.1. Figure 11.2 and Table 11.3 and 11.4 also show how DUPLEX splits the original points into estimation and prediction data. The convex hulls of the two data sets are shown in Figure 11.2. This indicates that the prediction data set contains both interpolation and extrapolation points. For these two data sets we find that $|\mathbf{X}'_E \mathbf{X}_E| = 0.44696$ and $|\mathbf{X}'_P \mathbf{X}_P| = 0.22441$. Thus,

$$\left(\frac{|\mathbf{X}'_E \mathbf{X}_E|}{|\mathbf{X}'_P \mathbf{X}_P|} \right)^{1/3} = \left(\frac{0.44696}{0.22441} \right)^{1/3} = 1.26$$

indicating that the volumes of the two regions are very similar. The VIFs for the estimation and prediction data are 2.22 and 4.43, respectively, so there is no strong evidence of multicollinearity and both data sets have similar correlative structure.

Panel A of Table 11.5 summarizes a least-squares fit to the estimation data. The parameter estimates in this model exhibit reasonable signs and magnitudes, and the VIFs are acceptably small. Analysis of the residuals (not shown) reveals no severe model inadequacies, except that the normal probability plot indicates that the error distribution has heavier tails than the normal. Checking Table 11.3, we see that point 9, which has previously been shown to be influential, is in the estimation data set. Apart from our concern about the normality assumption and the influence of point 9, we conclude that the least-squares fit to the estimation data is not unreasonable.

TABLE 11.4 Delivery Time Data with Near-Neighborhood Points Averaged

Observation, i	(1)		(2)		Estimation (E) or Prediction (P) Data Set
	Original Variables		Standardized Orthonormalized Data		
	Cases, x_1	Distance, x_2	w_1	w_2	
1	7	560	-.047671	.158431	P
2	3	220	-.136037	.013739	P
3	3	340	.136037	.108082	P
4	4	80	-.113945	-.126981	E
5	6	150	-.069762	-.133254	E
6	7	330	-.047671	-.022393	E
7	2	110	-.158128	-.042089	E
8	7	210	-.047671	-.116736	E
9	30	1460	.460432	.160977	E
10	5	605	-.091854	.255116	E
11	16	688	.151152	-.016816	P
12	10	215	.018603	-.204765	P
13	4	255	-.113945	.010603	E
14	6	462	-.069762	.112038	P
15, 23	9	449	-.003488	.009857	E
16, 32	10	775.5	.018603	.235895	P
17	6	200	-.069762	-.093945	P
18	7	132	-.047671	-.178059	E
19	3	36	-.136037	-.130920	P
20	17	770	.173243	.016998	E
21	10	140	.018603	-.263729	E
22	26	810	.372066	-.227434	E
24	8	635	-.025580	.186742	E
25	4	150	-.113945	-.071948	E
26	22	905	.283700	-.030133	P
27	7	520	-.047671	.126983	E
28	15	290	.129060	-.299067	P
29	5	500	-.091854	.172566	E
30	6	1000	-.069762	.535009	E
31	6	225	-.069762	-.074290	E
33	4	212	-.113945	-.023204	P
34	1	144	-.180219	.015295	P
35	3	126	-.136037	-.060163	P
36	12	655	.062786	.079853	P
37	10	420	.018603	-.043596	P
38	7	150	-.047671	-.163907	P
39	8	360	-.025580	-.029461	P
40	32	1530	.504614	.154704	P

Columns 2 and 3 of Table 11.6 show the results of predicting the observations in the prediction data set using the least-squares model developed from the estimation data. We see that the predicted values generally correspond closely to the observed values. The only unusually large prediction error is for point 40, which has the largest observed time in the prediction data. This point also has the largest values of x_1 (32

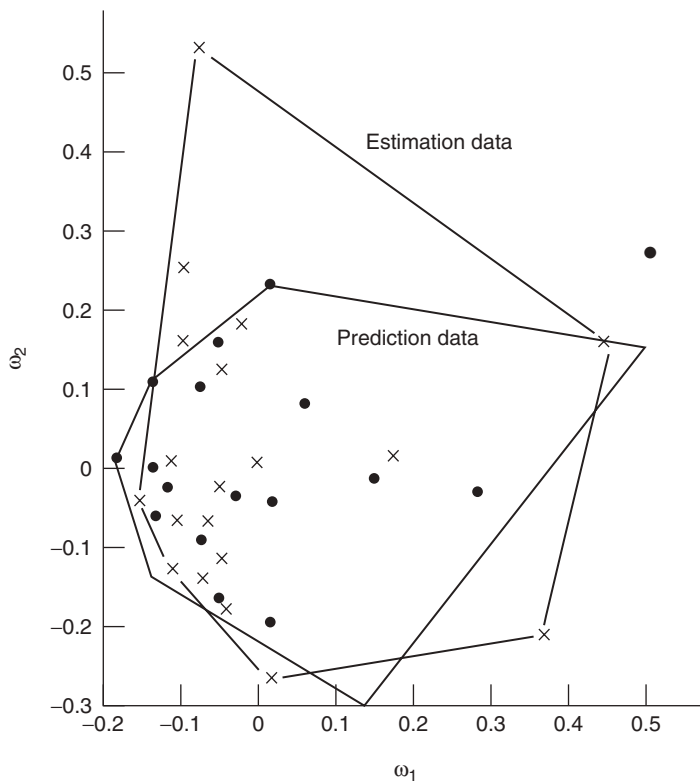

Figure 11.2 Estimation data (x) and prediction data (•) using orthonormalized regressors.

TABLE 11.5 Summary of Least-Squares Fit to the Delivery Time Data

A. Analysis Using Estimation Data				B. Analysis Using All Data			
Variable	Coefficient Estimate	Standard Error	t_0	Variable	Coefficient Estimate	Standard Error	t_0
Intercept	2.4123	1.4165	1.70	Intercept	3.9840	0.9861	4.04
x_1	1.6392	0.1769	9.27	x_1	1.4877	0.1376	10.81
x_2	0.0136	0.0036	3.78	x_2	0.0134	0.0028	4.72
$MS_{Res} = 13.9145, R^2 = 0.952$				$MS_{Res} = 13.6841, R^2 = 0.944$			

cases) and x_2 (1530 ft) in the entire data set. It is very similar to point 9 in the estimation data ($x_1 = 30, x_2 = 1460$) but represents an extrapolation for the model fit to the estimation data. The sum of squares of the prediction errors is $\sum e_i^2 = 322.4452$, and the approximate R^2 for prediction is

$$R^2_{\text{Prediction}} = 1 - \frac{\sum e_i^2}{SS_T} = 1 - \frac{322.4452}{4113.5442} = 0.922$$

TABLE 11.6 Prediction Performance for the Model Developed from the Estimation Data

	(1)	(2)	(3)
		Least-Squares Fit	
Observation, i	Observed, y_i	Predicted, \hat{y}_i	Prediction Error, $e_i = y_i - \hat{y}_i$
1	16.68	21.4976	-4.8176
2	11.50	10.3199	1.1801
3	12.03	11.9508	0.0792
11	40.33	37.9901	2.3399
12	21.00	21.7264	-0.7264
14	19.75	18.5265	1.2235
16	29.00	29.3509	-0.3509
17	15.35	14.9657	0.3843
19	9.50	7.8192	1.6808
26	51.00	50.7746	0.2254
28	26.16	30.9417	-4.7817
32	31.93	29.3373	2.5927
33	16.95	11.8504	5.0996
34	7.00	6.0086	0.9914
35	14.00	9.0424	4.9576
36	37.03	30.9848	6.0452
37	18.62	24.5125	-5.8925
38	16.10	15.9254	0.1746
39	24.38	20.4187	3.9613
40	64.75	75.6609	-10.9109

where $SS_T = 4113.5442$ is the corrected sum of squares of the responses in the prediction data set. Thus, we might expect this model to “explain” about 92.2% of the variability in new data, as compared to the 95.2% of the variability explained by the least-squares fit to the estimation data. This loss in R^2 is small, so there is reasonably strong evidence that the least-squares model will be a satisfactory predictor. ■

11.3 DATA FROM PLANNED EXPERIMENTS

Most of the validation techniques discussed in this chapter assume that the model has been developed from unplanned data. While the techniques could also be applied in situations where a designed experiment has been used to collect the data, usually validation of a model developed from such data is somewhat easier. Many experimental designs result in regression coefficients that are nearly uncorrelated, so multicollinearity is not usually a problem. An important aspect of experimental design is selection of the factors to be studied and identification of the ranges they are to be varied over. If done properly, this helps ensure that all the important regressors are included in the data and that an appropriate range of values has been obtained for each regressor. Furthermore, in designed experiments considerable

effort is usually devoted to the data collection process itself. This helps to minimize problems with “wild” or dubious observations and yields data with relatively small measurement errors.

When planned experiments are used to collect data, it is usually desirable to perform additional trials for use in testing the predictive performance of the model. In the experimental design literature, these extra trials are called **confirmation runs**. A widely used approach is to include the points that would allow fitting a model one degree higher than presently employed. Thus, if we are contemplating fitting a first-order model, the design should include enough points to fit at least some of the terms in a second-order model.

PROBLEMS

- 11.1** Consider the regression model developed for the National Football League data in Problem 3.1.
- Calculate the PRESS statistic for this model. What comments can you make about the likely predictive performance of this model?
 - Delete half the observations (chosen at random), and refit the regression model. Have the regression coefficients changed dramatically? How well does this model predict the number of games won for the deleted observations?
 - Delete the observation for Dallas, Los Angeles, Houston, San Francisco, Chicago, and Atlanta and refit the model. How well does this model predict the number of games won by these teams?
- 11.2** Split the National Football League data used in Problem 3.1 into estimation and prediction data sets. Evaluate the statistical properties of these two data sets. Develop a model from the estimation data and evaluate its performance on the prediction data. Discuss the predictive performance of this model.
- 11.3** Calculate the PRESS statistic for the model developed from the estimation data in Problem 11.2. How well is the model likely to predict? Compare this indication of predictive performance with the actual performance observed in Problem 11.2.
- 11.4** Consider the delivery time data discussed in Example 11.3. Find the PRESS statistic for the model developed from the estimation data. How well is the model likely to perform as a predictor? Compare this with the observed performance in prediction.
- 11.5** Consider the delivery time data discussed in Example 11.3.
- Develop a regression model using the prediction data set.
 - How do the estimates of the parameters in this model compare with those from the model developed from the estimation data? What does this imply about model validity?
 - Use the model developed in part a to predict the delivery times for the observations in the original estimation data. Are your results consistent with those obtained in Example 11.3?

- 11.6** In Problem 3.5 a regression model was developed for the gasoline mileage data using the regressor engine displacement x_1 and number of carburetor barrels x_6 . Calculate the PRESS statistic for this model. What conclusions can you draw about the model's likely predictive performance?
- 11.7** In Problem 3.6 a regression model was developed for the gasoline mileage data using the regressor vehicle length x_8 and vehicle weight x_{10} . Calculate the PRESS statistic for this model. What conclusions can you draw about the potential performance of this model as a predictor?
- 11.8** PRESS statistics for two different models for the gasoline mileage data were calculated in Problems 11.6 and 11.7. On the basis of the PRESS statistics, which model do you think is the best predictor?
- 11.9** Consider the gasoline mileage data in Table B.3. Delete eight observations (chosen at random) from the data and develop an appropriate regression model. Use this model to predict the eight withheld observations. What assessment would you make of this model's predictive performance?
- 11.10** Consider the gasoline mileage .data in Table B.3. Split the data into estimation and prediction sets.
- Evaluate the statistical properties of these data sets.
 - Fit a model involving x_1 and x_6 to the estimation data. Do the coefficients and fitted values from this model seem reasonable?
 - Use this model to predict the observations in the prediction data set. What is your evaluation of this model's predictive performance?
- 11.11** Refer to Problem 11.2. What are the standard errors of the regression coefficients for the model developed from the estimation data? How do they compare with the standard errors for the model in Problem 3.5 developed using all the data?
- 11.12** Refer to Problem 11.2. Develop a model for the National Football League data using the prediction data set.
- How do the coefficients and estimated values compare with those quantities for the models developed from the estimation data?
 - How well does this model predict the observations in the original estimation data set?
- 11.13** What difficulties do you think would be encountered in developing a computer program to implement the DUPLEX algorithm? For example, how efficient is the procedure likely to be for large sample sizes? What modifications in the procedure would you suggest to overcome those difficulties?
- 11.14** If \mathbf{Z} is the $n \times k$ matrix of standardized regressors and \mathbf{T} is the $k \times k$ upper triangular matrix in Eq. (11.3), show that the transformed regressors $\mathbf{W} = \mathbf{Z}\mathbf{T}^{-1}$ are orthogonal and have unit variance.
- 11.15** Show that the least-squares estimate of $\boldsymbol{\beta}$ (say $\hat{\boldsymbol{\beta}}_{(i)}$) with the i th observation deleted can be written in terms of the estimate based on all n points as

$$\hat{\boldsymbol{\beta}}_{(i)} = \hat{\boldsymbol{\beta}} - \frac{e_i}{1 - h_{ii}} (\mathbf{X}'\mathbf{X})^{-1} \mathbf{x}_i$$

- 11.16** Consider the heat treating data in Table B.12. Split the data into prediction and estimation data sets.
- Fit a model to the estimation data set using all possible regressions. Select the minimum C_p model.
 - Use the model in part a to predict the responses for each observation in the prediction data set. Calculate R^2 for prediction. Comment on model adequacy.
- 11.17** Consider the jet turbine engine thrust data in Table B.13. Split the data into prediction and estimation data sets.
- Fit a model to the estimation data using all possible regressions. Select the minimum C_p model.
 - Use the model in part a to predict each observation in the prediction data set. Calculate R^2 for prediction. Comment on model adequacy.
- 11.18** Consider the electronic inverter data in Table B.14. Delete the second observation in the data set. Split the remaining observations into prediction and estimation data sets.
- Find the minimum C_p equation for the estimation data set.
 - Use the model in part a to predict each observation in the prediction data set. Calculate R^2 for prediction and comment on model adequacy.
- 11.19** Table B.11 presents 38 observations on wine quality.
- Select four observations at random from this data set, then delete these observations and fit a model involving only the regressor flavor and the indicator variables for the region information to the remaining observations. Use this model to predict the deleted observations and calculate R^2 for prediction.
 - Repeat part a 100 times and compute the average R^2 for prediction for all 100 repetitions.
 - Fit the model to all 38 observations and calculate the R^2 for prediction based on PRESS.
 - Comment on all three approaches from parts a–c above as measures of model validity.
- 11.20** Consider all 40 observations on the delivery time data. Delete 10% (4) of the observations at random. Fit a model to the remaining 36 observations, predict the four deleted values, and calculate R^2 for prediction. Repeat these calculations 100 times. Calculate the average R^2 for prediction. What information does this convey about the predictive capability of the model? How does the average of the 100 R^2 for prediction values compare to R^2 for prediction based on PRESS for all 40 observations?

INTRODUCTION TO NONLINEAR REGRESSION

Linear regression models provide a rich and flexible framework that suits the needs of many analysts. However, linear regression models are not appropriate for all situations. There are many problems in engineering and the sciences where the response variable and the predictor variables are related through a known **nonlinear** function. This leads to a **nonlinear regression model**. When the method of least squares is applied to such models, the resulting normal equations are nonlinear and, in general, difficult to solve. The usual approach is to directly minimize the residual sum of squares by an iterative procedure. In this chapter we describe estimating the parameters in a nonlinear regression model and show how to make appropriate inferences on the model parameters. We also illustrate computer software for nonlinear regression.

12.1 LINEAR AND NONLINEAR REGRESSION MODELS

12.1.1 Linear Regression Models

In previous chapters we have concentrated on the **linear regression model**

$$y = \beta_0 + \beta_1 x_1 + \beta_2 x_2 + \cdots + \beta_k x_k + \varepsilon \quad (12.1)$$

These models include not only the first-order relationships, such as Eq. (12.1), but also polynomial models and other more complex relationships. In fact, we could write the linear regression model as

Introduction to Linear Regression Analysis, Fifth Edition. Douglas C. Montgomery, Elizabeth A. Peck, G. Geoffrey Vining.

© 2012 John Wiley & Sons, Inc. Published 2012 by John Wiley & Sons, Inc.

$$y = \beta_0 + \beta_1 z_1 + \beta_2 z_2 + \cdots + \beta_r z_r + \varepsilon \quad (12.2)$$

where z_i represents any **function** of the original regressors x_1, x_2, \dots, x_k , including transformations such as $\exp(x_i)$, $\sqrt{x_i}$, and $\sin(x_i)$. These models are called **linear regression models** because they are **linear in the unknown parameters**, the $\beta_j, j = 1, 2, \dots, k$.

We may write the linear regression model (12.1) in a general form as

$$\begin{aligned} y &= \mathbf{x}'\boldsymbol{\beta} + \varepsilon \\ &= f(\mathbf{x}, \boldsymbol{\beta}) + \varepsilon \end{aligned} \quad (12.3)$$

where $\mathbf{x}' = [1, x_1, x_2, \dots, x_k]$. Since the expected value of the model errors is zero, the expected value of the response variable is

$$\begin{aligned} E(y) &= E[f(\mathbf{x}, \boldsymbol{\beta}) + \varepsilon] \\ &= f(\mathbf{x}, \boldsymbol{\beta}) \end{aligned}$$

We usually refer to $f(\mathbf{x}, \boldsymbol{\beta})$ as the **expectation function** for the model. Obviously, the expectation function here is just a linear function of the unknown parameters.

12.1.2 Nonlinear Regression Models

There are many situations where a linear regression model may not be appropriate. For example, the engineer or scientist may have direct knowledge of the form of the relationship between the response variable and the regressors, perhaps from the theory underlying the phenomena. The true relationship between the response and the regressors may be a differential equation or the solution to a differential equation. Often, this will lead to a model of nonlinear form.

Any model that is not linear in the unknown parameters is a **nonlinear regression model**. For example, the model

$$y = \theta_1 e^{\theta_2 x} + \varepsilon \quad (12.4)$$

is not linear in the unknown parameters θ_1 and θ_2 . We will use the symbol θ to represent a parameter in a nonlinear model to emphasize the difference between the linear and the nonlinear case.

In general, we will write the nonlinear regression model as

$$y = f(\mathbf{x}, \boldsymbol{\theta}) + \varepsilon \quad (12.5)$$

where $\boldsymbol{\theta}$ is a $p \times 1$ vector of unknown parameters and ε is an uncorrelated random-error term with $E(\varepsilon) = 0$ and $\text{Var}(\varepsilon) = \sigma^2$. We also typically assume that the errors are normally distributed, as in linear regression. Since

$$\begin{aligned} E(y) &= E[f(\mathbf{x}, \boldsymbol{\theta}) + \varepsilon] \\ &= f(\mathbf{x}, \boldsymbol{\theta}) \end{aligned} \quad (12.6)$$

we call $f(\mathbf{x}, \boldsymbol{\theta})$ the **expectation function** for the nonlinear regression model. This is very similar to the linear regression case, except that now the expectation function is a **nonlinear** function of the parameters.

In a nonlinear regression model, at least one of the derivatives of the expectation function with respect to the parameters depends on at least one of the parameters. In linear regression, these derivatives are **not** functions of the unknown parameters. To illustrate these points, consider a linear regression model

$$y = \beta_0 + \beta_1 x_1 + \beta_2 x_2 + \cdots + \beta_k x_k + \varepsilon$$

with expectation function $f(\mathbf{x}, \boldsymbol{\beta}) = \beta_0 + \sum_{j=1}^k \beta_j x_j$. Now

$$\frac{\partial f(\mathbf{x}, \boldsymbol{\beta})}{\partial \beta_j} = x_j, \quad j = 0, 1, \dots, k$$

where $x_0 \equiv 1$. Notice that in the linear case the derivatives are **not** functions of the β s

Now consider the nonlinear model

$$\begin{aligned} y &= f(x, \boldsymbol{\theta}) + \varepsilon \\ &= \theta_1 e^{\theta_2 x} + \varepsilon \end{aligned}$$

The derivatives of the expectation function with respect to θ_1 and θ_2 are

$$\frac{\partial f(x, \boldsymbol{\theta})}{\partial \theta_1} = e^{\theta_2 x} \quad \text{and} \quad \frac{\partial f(x, \boldsymbol{\theta})}{\partial \theta_2} = \theta_1 x e^{\theta_2 x}$$

Since the derivatives are a function of the unknown parameters θ_1 and θ_2 , the model is nonlinear.

12.2 ORIGINS OF NONLINEAR MODELS

Nonlinear regression models often strike people as being very ad hoc because these models typically involve mathematical functions that are nonintuitive to people outside of the specific application area. Too often, people fail to appreciate the scientific theory underlying these nonlinear regression models. The scientific method uses mathematical models to describe physical phenomena. In many cases, the theory describing the physical relationships involves the solution of a set of differential equations, especially whenever rates of change are the basis for the mathematical model. This section outlines how the differential equations that form the heart of the theory describing physical behavior lead to nonlinear models. We discuss two examples. The first example deals with reaction rates and is more straightforward. The second example gives more details about the underlying theory to illustrate why nonlinear regression models have their specific forms. Our key point is that nonlinear regression models are almost always deeply rooted in the appropriate science.

Example 12.1

We first consider formally incorporating the effect of temperature into a second-order reaction kinetics model. For example, the hydrolysis of ethyl acetate is well modeled by a second-order kinetics model. Let A_t be the amount of ethyl acetate at time t . The second-order model is

$$\frac{dA_t}{dt} = -kA_t^2$$

where k is the rate constant. Rate constants depend on temperature, which we will incorporate into our model later. Let A_0 be the amount of ethyl acetate at time zero. The solution to the rate equation is

$$\frac{1}{A_t} = \frac{1}{A_0} + kt$$

With some algebra, we obtain

$$A_t = \frac{A_0}{1 + A_0tk}$$

We next consider the impact of temperature on the rate constant. The Arrhenius equation states

$$k = C_1 \exp\left(-\frac{E_a}{RT}\right)$$

where E_a is the activation energy and C_1 is a constant. Substituting the Arrhenius equation into the rate equation yields

$$A_t = \frac{A_0}{1 + A_0tC_1 \exp(-E_a/RT)}$$

Thus, an appropriate nonlinear regression model is

$$A_t = \frac{\theta_1}{1 + \theta_2 t \exp(-\theta_3/T)} + \varepsilon_t \quad (12.7)$$

where $\theta_1 = A_0$, $\theta_2 = C_1 A_0$, and $\theta_3 = E_a/R$. ■

Example 12.2

We next consider the Clausius–Clapeyron equation, which is an important result in physical chemistry and chemical engineering. This equation describes the relationship of vapor pressure and temperature.

Vapor pressure is the physical property which explains why puddles of water evaporate away. Stable liquids at a given temperature are those that have achieved an equilibrium with their vapor phase. The vapor pressure is the partial pressure of the vapor phase at this equilibrium. If the vapor pressure equals the ambient pressure, then the liquid boils. Puddles evaporate when the partial pressure of the water vapor in the ambient atmosphere is less than the vapor pressure of water at that temperature. The nonequilibrium condition presented by this difference between the actual partial pressure and the vapor pressure causes the puddle's water to evaporate over time.

The chemical theory that describes the behavior at the vapor–liquid interface notes that at equilibrium the Gibbs free energies of both the vapor and liquid phases must be equal. The Gibbs free energy G is given by

$$G = U + PV - TS = H - TS$$

where U is the “internal energy,” P is the pressure, V is the volume, T is the “absolute” temperature, S is the entropy, and $H = U + PV$ is the enthalpy. Typically, in thermodynamics, we are more interested in the change in Gibbs free energy than its absolute value. As a result, the actual value of U is often of limited interest. The derivation of the Clausius–Clapeyron equation also makes use of the ideal gas law,

$$PV = RT$$

where R is the ideal gas constant.

Consider the impact of a slight change in the temperature when holding the volume fixed. From the ideal gas law, we observe that an increase in the temperature necessitates an increase in the pressure. Let dG be the resulting differential in the Gibbs free energy. We note that

$$\begin{aligned} dG &= \left(\frac{\partial G}{\partial P} \right)_T dP + \left(\frac{\partial G}{\partial T} \right)_P dT \\ &= VdP - SdT \end{aligned}$$

Let the subscript 1 denote the liquid phase and the subscript v denote the vapor phase. Thus, G_1 and G_v are the Gibbs free energies of the liquid and vapor phases, respectively. If we maintain the vapor–liquid equilibrium as we change the temperature and pressure, then

$$\begin{aligned} dG_1 &= dG_v \\ V_1 dP - S_1 dT &= V_v dP - S_v dT \end{aligned}$$

Rearranging, we obtain

$$\frac{dP}{dT} = \frac{S_v - S_1}{V_v - V_1} \quad (12.8)$$

We observe that the volume occupied by the vapor is much larger than the volume occupied by the liquid. Effectively, the difference is so large that we can treat V_1 as zero. Next, we observe that entropy is defined by

$$dS = \frac{dQ}{T}$$

where Q is the heat exchanged reversibly between the system and its surroundings. For our vapor–liquid equilibrium situation, the net heat exchanged is H_{vap} , which is the heat of vaporization at temperature T . Thus,

$$S_v - S_l = \frac{H_{\text{vap}}}{T}$$

We then can rewrite (12.8) as

$$\frac{dP}{dT} = \frac{H_{\text{vap}}}{VT}$$

From the ideal gas law,

$$V = \frac{RT}{P}$$

We then may rewrite (12.8) as

$$\frac{dP}{dT} = \frac{PH_{\text{vap}}}{RT^2}$$

Rearranging, we obtain,

$$\frac{dP}{P} = \frac{H_{\text{vap}}dT}{RT^2}$$

Integrating, we obtain

$$\ln(P) = C - C_1 \frac{1}{T} \quad (12.9)$$

where C is an integration constant and

$$C_1 = \frac{H_{\text{vap}}}{R}$$

We can reexpress (12.9) as

$$P = C_0 + C \exp\left(-\frac{C_1}{T}\right) \quad (12.10)$$

where C_0 is another integration constant. Equation (12.9) suggests a simple linear regression model of the form

$$\ln(P)_i = \beta_0 + \beta_1 \frac{1}{T_i} + \varepsilon_i \tag{12.11}$$

Equation (12.10) on the other hand, suggests a nonlinear regression model of the form

$$P_i = \theta_1 \exp\left(\frac{\theta_2}{T_i}\right) + \varepsilon_i \tag{12.12}$$

It is important to note that there are subtle, yet profound differences between these two possible models. We discuss some of the possible differences between linear and nonlinear models in Section 12.4. ■

12.3 NONLINEAR LEAST SQUARES

Suppose that we have a sample of n observations on the response and the regressors, say $y_i, x_{i1}, x_{i2}, \dots, x_{ik}$, for $i = 1, 2, \dots, n$. We have observed previously that the method of least squares in linear regression involves minimizing the least-squares function

$$S(\boldsymbol{\beta}) = \sum_{i=1}^n \left[y_i - \left(\beta_0 + \sum_{j=1}^k \beta_j x_{ij} \right) \right]^2$$

Because this is a linear regression model, when we differentiate $S(\boldsymbol{\beta})$ with respect to the unknown parameters and equate the derivatives to zero, the resulting normal equations are **linear** equations, and consequently, they are easy to solve.

Now consider the nonlinear regression situation. The model is

$$y_i = f(\mathbf{x}_i, \boldsymbol{\theta}) + \varepsilon_i, \quad i = 1, 2, \dots, n$$

where now $\mathbf{x}'_i = [1, x_{i1}, x_{i2}, \dots, x_{ik}]$ for $i = 1, 2, \dots, n$. The least-squares function is

$$S(\boldsymbol{\theta}) = \sum_{i=1}^n [y_i - f(\mathbf{x}_i, \boldsymbol{\theta})]^2 \tag{12.13}$$

To find the least-squares estimates we must differentiate Eq. (12.13) with respect to each element of $\boldsymbol{\theta}$. This will provide a set of p normal equations for the nonlinear regression situation. The normal equations are

$$\sum_{i=1}^n [y_i - f(\mathbf{x}_i, \boldsymbol{\theta})] \left[\frac{\partial f(\mathbf{x}_i, \boldsymbol{\theta})}{\partial \theta_j} \right]_{\boldsymbol{\theta}=\hat{\boldsymbol{\theta}}} = 0 \quad \text{for } j = 1, 2, \dots, p \tag{12.14}$$

In a nonlinear regression model the derivatives in the large square brackets will be functions of the unknown parameters. Furthermore, the expectation function is also a nonlinear function, so the normal equations can be very difficult to solve.

Example 12.3 Normal Equations for a Nonlinear Model

Consider the nonlinear regression model in Eq. (12.4):

$$y = \theta_1 e^{\theta_2 x} + \varepsilon$$

The least-squares normal equations for this model are

$$\begin{aligned} \sum_{i=1}^n [y_i - \hat{\theta}_1 e^{\hat{\theta}_2 x_i}] e^{\hat{\theta}_2 x_i} &= 0 \\ \sum_{i=1}^n [y_i - \hat{\theta}_1 e^{\hat{\theta}_2 x_i}] \hat{\theta}_1 x_i e^{\hat{\theta}_2 x_i} &= 0 \end{aligned} \quad (12.15)$$

After simplification, the normal equations are

$$\begin{aligned} \sum_{i=1}^n y_i e^{\hat{\theta}_2 x_i} - \hat{\theta}_1 \sum_{i=1}^n e^{2\hat{\theta}_2 x_i} &= 0 \\ \sum_{i=1}^n y_i x_i e^{\hat{\theta}_2 x_i} - \hat{\theta}_1 \sum_{i=1}^n x_i e^{2\hat{\theta}_2 x_i} &= 0 \end{aligned} \quad (12.16)$$

These equations are not linear in $\hat{\theta}_1$ and $\hat{\theta}_2$, and no simple closed-form solution exists. In general, **iterative methods** must be used to find the values of $\hat{\theta}_1$ and $\hat{\theta}_2$. To further complicate the problem, sometimes there are multiple solutions to the normal equations. That is, there are multiple stationary values for the residual sum of squares function $S(\theta)$. ■

Geometry of Linear and Nonlinear Least Squares Examining the geometry of the least-squares problem is helpful in understanding the complexities introduced by a nonlinear model. For a given sample, the residual-sum-of-squares function $S(\theta)$ depends only on the model parameters θ . Thus, in the parameter space (the space defined by the $\theta_1, \theta_2, \dots, \theta_p$), we can represent the function $S(\theta)$ with a contour plot, where each contour on the surface is a line of constant residual sum of squares.

Suppose the regression model is linear; that is, the parameters are $\theta = \beta$, and the residual-sum-of-squares function is $S(\beta)$ Figure 12.1a shows the contour plot for this situation. If the model is linear in the unknown parameters, the contours are ellipsoidal and have a unique global minimum at the least-squares estimator $\hat{\beta}$.

When the model is nonlinear, the contours will often appear as in Figure 12.1b. Notice that these contours are not elliptical and are in fact quite elongated and irregular in shape. A “banana-shape” appearance is very typical. The specific shape and orientation of the residual sum of squares contours depend on the form of the nonlinear model and the sample of data that have been obtained. Often the surface will be very elongated near the optimum, so many solutions for θ will produce a residual sum of squares that is close to the global minimum. This results in a problem that is **ill-conditioned**, and in such problems it is often difficult to find the global minimum for θ . In some situations, the contours may be so irregular that there are several local minima and perhaps more than one global minimum. Figure 12.1c shows a situation where there is one local minimum and a global minimum.

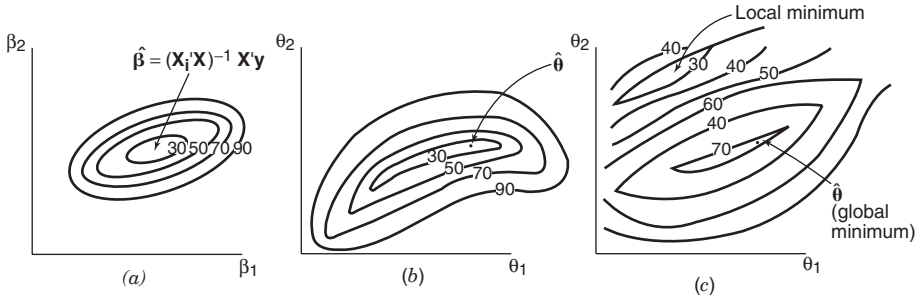

Figure 12.1 Contours of the residual-sum-of-squares function: (a) linear model; (b) nonlinear model; (c) nonlinear model with local and global minima.

Maximum-Likelihood Estimation We have concentrated on least squares in the nonlinear case. If the error terms in the model are normally and independently distributed with constant variance, application of the method of maximum likelihood to the estimation problem will lead to least squares. For example, consider the model in Eq. (12.4):

$$y_i = \theta_1 e^{\theta_2 x_i} + \varepsilon_i, \quad i = 1, 2, \dots, n \tag{12.17}$$

If the errors are normally and independently distributed with mean zero and variance σ^2 , then the likelihood function is

$$L(\theta, \sigma^2) = \frac{1}{(2\pi\sigma^2)^{n/2}} \exp\left[-\frac{1}{2\sigma^2} \sum_{i=1}^n [y_i - \theta_1 e^{\theta_2 x_i}]^2\right] \tag{12.18}$$

Clearly, maximizing this likelihood function is equivalent to minimizing the residual sum of squares. Therefore, in the normal-theory case, least-squares estimates are the same as maximum-likelihood estimates.

12.4 TRANSFORMATION TO A LINEAR MODEL

It is sometimes useful to consider a **transformation** that induces linearity in the model expectation function. For example, consider the model

$$\begin{aligned} y &= f(x, \boldsymbol{\theta}) + \varepsilon \\ &= \theta_1 e^{\theta_2 x} + \varepsilon \end{aligned} \tag{12.19}$$

The Clausius–Clapeyron equation (12.12) is an example of this model. Now since $E(y) = f(x, \boldsymbol{\theta}) = \theta_1 e^{\theta_2 x}$, we can linearize the expectation function by taking logarithms,

$$\ln E(y) = \ln \theta_1 + \theta_2 x$$

which we saw in Eq. (12.11) in our derivation of the Clausius–Clapeyron equation. Therefore, it is tempting to consider rewriting the model as

$$\begin{aligned}\ln y &= \ln \theta_1 + \theta_2 x + \varepsilon \\ &= \beta_0 + \beta_1 x + \varepsilon\end{aligned}\quad (12.20)$$

and using simple **linear** regression to estimate β_0 and β_1 . However, the linear least-squares estimates of the parameters in Eq. (12.20) will not in general be equivalent to the nonlinear parameter estimates in the original model (12.19). The reason is that in the **original nonlinear model** least squares implies minimization of the sum of squared residuals on y , whereas in the **transformed model** (12.20) we are minimizing the sum of squared residuals on $\ln y$.

Note that in Eq. (12.19) the error structure is **additive**, so taking logarithms **cannot** produce the model in Eq. (12.20). If the error structure is **multiplicative**, say

$$y = \theta_1 e^{\theta_2 x} \varepsilon \quad (12.21)$$

then taking logarithms will be appropriate, since

$$\begin{aligned}\ln y &= \ln \theta_1 + \theta_2 x + \ln \varepsilon \\ &= \beta_0 + \beta_1 x + \varepsilon^*\end{aligned}\quad (12.22)$$

and if ε^* follows a normal distribution, all the standard linear regression model properties and associated inference will apply.

A nonlinear model that can be transformed to an equivalent linear form is said to be **intrinsically linear**. However, the issue often revolves around the error structure, namely, do the standard assumptions on the errors apply to the original nonlinear model or to the linearized one? This is sometimes not an easy question to answer.

Example 12.4 The Puromycin Data

Bates and Watts [1988] use the **Michaelis–Menten** model for chemical kinetics to relate the initial velocity of an enzymatic reaction to the substrate concentration x . The model is

$$y = \frac{\theta_1 x}{x + \theta_2} + \varepsilon \quad (12.23)$$

The data for the initial rate of a reaction for an enzyme treated with puromycin are shown in Table 12.1 and plotted in Figure 12.2.

We note that the expectation function can be linearized easily, since

$$\begin{aligned}\frac{1}{f(x, \theta)} &= \frac{x + \theta_2}{\theta_1 x} = \frac{1}{\theta_1} + \frac{\theta_2}{\theta_1} \frac{1}{x} \\ &= \beta_0 + \beta_1 x\end{aligned}$$

so we are tempted to fit the **linear** model

$$y^* = \beta_0 + \beta_1 u + \varepsilon$$

TABLE 12.1 Reaction Velocity and Substrate Concentration for Puromycin Experiment

Substrate Concentration (ppm)	Velocity [(counts/min)/min]	
0.02	47	76
0.06	97	107
0.11	123	139
0.22	152	159
0.56	191	201
1.10	200	207

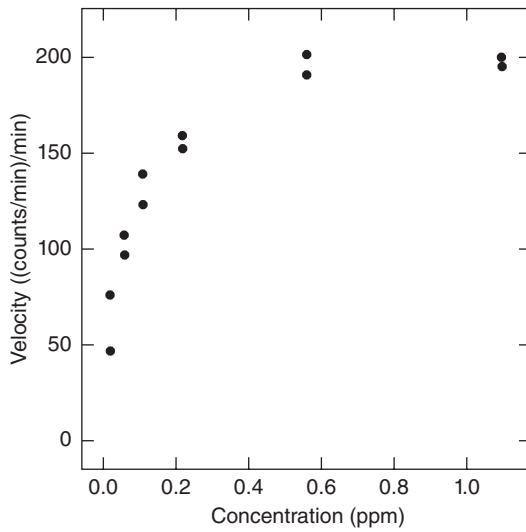

Figure 12.2 Plot of reaction velocity versus substrate concentration for the puromycin experiment. (Adapted from Bates and Watts [1988], with permission of the publisher.)

where $y^* = 1/y$ and $u = 1/x$. The resulting least-squares fit is

$$\hat{y}^* = 0.005107 + 0.0002472u$$

Figure 12.3a shows a scatterplot of the transformed data y^* and u with the straight-line fit superimposed. As there are replicates in the data, it is easy to see from Figure 12.2 that the variance of the original data is approximately constant, while Figure 12.3a indicates that in the transformed scale the constant-variance assumption is unreasonable.

Now since

$$\beta_0 = \frac{1}{\theta_1} \quad \text{and} \quad \beta_1 = \frac{\theta_2}{\theta_1}$$

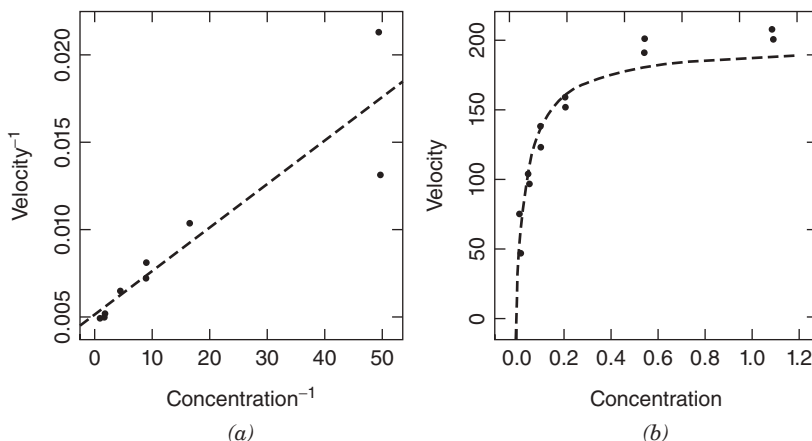

Figure 12.3 (a) Plot of inverse velocity versus inverse concentration for the puromycin data. (b) Fitted curve in the original scale. (Adapted from Bates and Watts [1988], with permission of the publisher.)

we have

$$0.005107 = \frac{1}{\hat{\theta}_1} \quad \text{and} \quad 0.0002472 = \frac{\hat{\theta}_2}{\hat{\theta}_1}$$

and so we can estimate θ_1 and θ_2 in the original model as

$$\hat{\theta}_1 = 195.81 \quad \text{and} \quad \hat{\theta}_2 = 0.04841$$

Figure 12.3b shows the fitted curve in the original scale along with the data. Observe from the figure that the fitted asymptote is too small. The variance at the replicated points has been distorted by the transformation, so runs with low concentration (high reciprocal concentration) dominate the least-squares fit, and as a result the model does not fit the data well at high concentrations. ■

12.5 PARAMETER ESTIMATION IN A NONLINEAR SYSTEM

12.5.1 Linearization

A method widely used in computer algorithms for nonlinear regression is **linearization** of the nonlinear function followed by the Gauss–Newton iteration method of parameter estimation. Linearization is accomplished by a **Taylor series expansion** of $f(\mathbf{x}_i, \boldsymbol{\theta})$ about the point $\boldsymbol{\theta}'_0 = [\theta_{10}, \theta_{20}, \dots, \theta_{p0}]$ with only the linear terms retained. This yields

$$f(\mathbf{x}_i, \boldsymbol{\theta}) = f(\mathbf{x}_i, \boldsymbol{\theta}_0) + \sum_{j=1}^p \left[\frac{\partial f(\mathbf{x}_i, \boldsymbol{\theta})}{\partial \theta_j} \right]_{\boldsymbol{\theta}=\boldsymbol{\theta}_0} (\theta_j - \theta_{j0}) \quad (12.24)$$

If we set

$$\begin{aligned} f_i^0 &= f(\mathbf{x}_i, \boldsymbol{\theta}_0) \\ \beta_j^0 &= \theta_j - \theta_{j0} \\ Z_{ij}^0 &= \left[\frac{\partial f(\mathbf{x}_i, \boldsymbol{\theta}_0)}{\partial \theta_j} \right]_{\boldsymbol{\theta}=\boldsymbol{\theta}_0} \end{aligned}$$

we note that the nonlinear regression model can be written as

$$y_i - f_i^0 = \sum_{j=1}^p \beta_j^0 Z_{ij}^0 + \varepsilon_i, \quad i = 1, 2, \dots, n \tag{12.25}$$

That is, we now have a linear regression model. We usually call $\boldsymbol{\theta}_0$ the starting values for the parameters.

We may write Eq. (12.25) as

$$\mathbf{y}_0 = \mathbf{Z}_0 \boldsymbol{\beta}_0 + \boldsymbol{\varepsilon} \tag{12.26}$$

so the estimate of $\boldsymbol{\beta}_0$ is

$$\hat{\boldsymbol{\beta}}_0 = (\mathbf{Z}'_0 \mathbf{Z}_0)^{-1} \mathbf{Z}'_0 \mathbf{y}_0 = (\mathbf{Z}'_0 \mathbf{Z}_0)^{-1} \mathbf{Z}'_0 (\mathbf{y} - \mathbf{f}_0) \tag{12.27}$$

Now since $\boldsymbol{\beta}_0 = \boldsymbol{\theta} - \boldsymbol{\theta}_0$, we could define

$$\hat{\boldsymbol{\theta}}_1 = \hat{\boldsymbol{\beta}}_0 + \boldsymbol{\theta}_0 \tag{12.28}$$

as revised estimates of $\boldsymbol{\theta}$. Sometimes $\hat{\boldsymbol{\beta}}_0$ is called the **vector of increments**. We may now place the revised estimates $\hat{\boldsymbol{\theta}}_1$ in Eq. (12.24) (in the same roles played by the initial estimates $\boldsymbol{\theta}_0$) and then produce another set of revised estimates, say $\hat{\boldsymbol{\theta}}_2$, and so forth.

In general, we have at the k th iteration

$$\hat{\boldsymbol{\theta}}_{k+1} = \hat{\boldsymbol{\theta}}_k + \hat{\boldsymbol{\beta}}_k = \hat{\boldsymbol{\theta}}_k + (\mathbf{Z}'_k \mathbf{Z}_k)^{-1} \mathbf{Z}'_k (\mathbf{y} - \mathbf{f}_k) \tag{12.29}$$

where

$$\begin{aligned} \mathbf{Z}_k &= [\mathbf{Z}_{ij}^k] \\ \mathbf{f}_k &= [f_1^k, f_2^k, \dots, f_n^k]' \\ \hat{\boldsymbol{\theta}}_k &= [\theta_{1k}, \theta_{2k}, \dots, \theta_{pk}]' \end{aligned}$$

This iterative process continues until convergence, that is, until

$$\left[(\hat{\theta}_{j,k+1} - \hat{\theta}_{jk}) / \hat{\theta}_{jk} \right] < \delta, \quad j = 1, 2, \dots, p$$

where δ is some small number, say 1.0×10^{-6} . At each iteration the residual sum of squares $S(\hat{\boldsymbol{\theta}}_k)$ should be evaluated to ensure that a reduction in its value has been obtained.

Example 12.5 The Puromycin Data

Bates and Watts [1988] use the Gauss–Newton method to fit the Michaelis–Menten model to the puromycin data in Table 12.1 using the starting values $\theta_{10} = 205$ and $\theta_{20} = 0.08$. Later we will discuss how these starting values were obtained. At this starting point, the residual sum of squares $S(\boldsymbol{\theta}_0) = 3155$. The data, fitted values, residuals, and derivatives evaluated at each observation are shown in Table 12.2. To illustrate how the required quantities are calculated, note that

$$\frac{\partial f(x, \theta_1, \theta_2)}{\partial \theta_1} = \frac{x}{\theta_2 + x} \quad \text{and} \quad \frac{\partial f(x, \theta_1, \theta_2)}{\partial \theta_2} = \frac{-\theta_1 x}{(\theta_2 + x)^2}$$

and since the first observation on x is $x_1 = 0.02$, we have

$$Z_{11}^0 = \left. \frac{x_1}{\theta_2 + x} \right|_{\theta_2=0.08} = \frac{0.02}{0.08 + 0.02} = 0.2000$$

$$Z_{12}^0 = \left. \frac{-\theta_1 x_1}{(\theta_2 + x)^2} \right|_{\theta_1=205, \theta_2=0.08} = \frac{(-205)(0.02)}{(0.08 + 0.02)^2} = -410.00$$

The derivatives Z_{ij}^0 are now collected into the matrix \mathbf{Z}_0 and the vector of increments calculated from Eq. (12.27) as

$$\hat{\boldsymbol{\beta}}_0 = \begin{bmatrix} 8.03 \\ -0.017 \end{bmatrix}$$

TABLE 12.2 Data, Fitted Values, Residuals, and Derivatives for the Puromycin Data at $\hat{\boldsymbol{\theta}}_0 = [205, 0.08]'$

i	x_i	y_i	f_i^0	$y_i - f_i^0$	Z_{i1}^0	Z_{i2}^0
1	0.02	76	41.00	35.00	0.2000	-410.00
2	0.02	47	41.00	6.00	0.2000	-410.00
3	0.06	97	87.86	9.14	0.4286	-627.55
4	0.06	107	87.86	19.14	0.4286	-627.55
5	0.11	123	118.68	4.32	0.5789	-624.65
6	0.11	139	118.68	20.32	0.5789	-624.65
7	0.22	159	150.33	8.67	0.7333	-501.11
8	0.22	152	150.33	1.67	0.7333	-501.11
9	0.56	191	179.38	11.62	0.8750	-280.27
10	0.56	201	179.38	21.62	0.8750	-280.27
11	1.10	207	191.10	15.90	0.9322	-161.95
12	1.10	200	191.10	8.90	0.9322	-161.95

The revised estimate $\hat{\theta}_1$ from Eq. (12.28) is

$$\begin{aligned} \hat{\theta}_1 &= \hat{\beta}_0 + \theta_0 \\ &= \begin{bmatrix} 8.03 \\ -0.017 \end{bmatrix} + \begin{bmatrix} 205.00 \\ 0.08 \end{bmatrix} = \begin{bmatrix} 213.03 \\ 0.063 \end{bmatrix} \end{aligned}$$

The residual sum of squares at this point is $S(\hat{\theta}_1) = 1206$, which is considerably smaller than $S(\theta_0)$. Therefore, $\hat{\theta}_1$ is adopted as the revised estimate of θ , and another iteration would be performed.

The Gauss–Newton algorithm converged at $\hat{\theta}' = [212.7, 0.0641]'$ with $S(\hat{\theta}) = 1195$. Therefore, the fitted model obtained by linearization is

$$\hat{y} = \frac{\hat{\theta}_1 x}{x + \hat{\theta}_2} = \frac{212.7x}{x + 0.0641}$$

Figure 12.4 shows the fitted model. Notice that the nonlinear model provides a much better fit to the data than did the transformation followed by linear regression in Example 12.4 (compare Figures 12.4 and 12.3*b*).

Residuals can be obtained from a fitted nonlinear regression model in the usual way, that is,

$$e_i = y_i - \hat{y}_i, \quad i = 1, 2, \dots, n$$

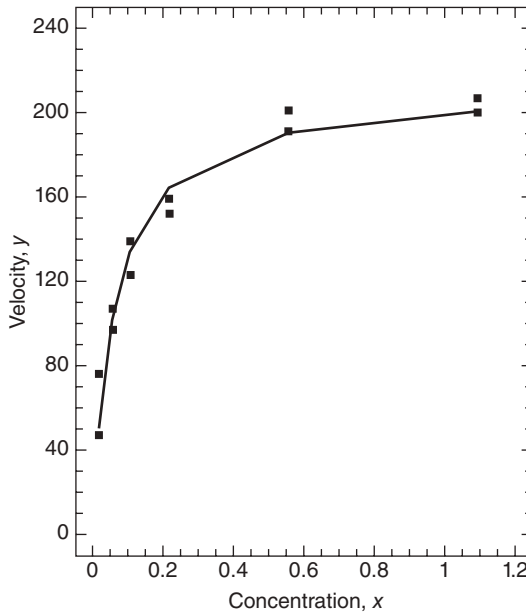

Figure 12.4 Plot of fitted nonlinear regression model, Example 12.5.

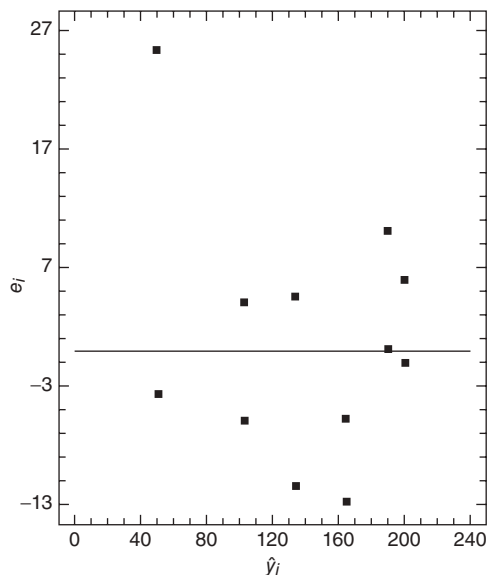

Figure 12.5 Plot of residuals versus predicted values, Example 12.5.

In this example the residuals are computed from

$$e_i = y_i - \frac{\hat{\theta}_1 x_i}{x_i + \hat{\theta}_2} = y_i - \frac{212.7x}{x_i + 0.0641}, \quad i = 1, 2, \dots, 10$$

The residuals are plotted versus the predicted values in Figure 12.5. A normal probability plot of the residuals is shown in Figure 12.6. There is one moderately large residual; however, the overall fit is satisfactory, and the model seems to be a substantial improvement over that obtained by the transformation approach in Example 12.4. ■

Computer Programs Several PC statistics packages have the capability to fit nonlinear regression models. Both JMP and Minitab (version 16 and higher) have this capability. Table 12.3 is the output from JMP that results from fitting the Michaelis–Menten model to the puromycin data in Table 12.1. JMP required 13 iterations to converge to the final parameter estimates. The output provides the estimates of the model parameters, approximate standard errors of the parameter estimates, the error or residual sum of squares, and the correlation matrix of the parameter estimates. We make use of some of these quantities in later sections.

Estimation of σ^2 When the estimation procedure converges to a final vector of parameter estimates $\hat{\theta}$, we can obtain an estimate of the error variance σ^2 from the residual mean square

$$\hat{\sigma}^2 = MS_{\text{Res}} = \frac{\sum_{i=1}^n (y_i - \hat{y}_i)^2}{n-p} = \frac{\sum_{i=1}^n [y_i - f(\mathbf{x}_i, \hat{\theta})]^2}{n-p} = \frac{S(\hat{\theta})}{n-p} \quad (12..30)$$

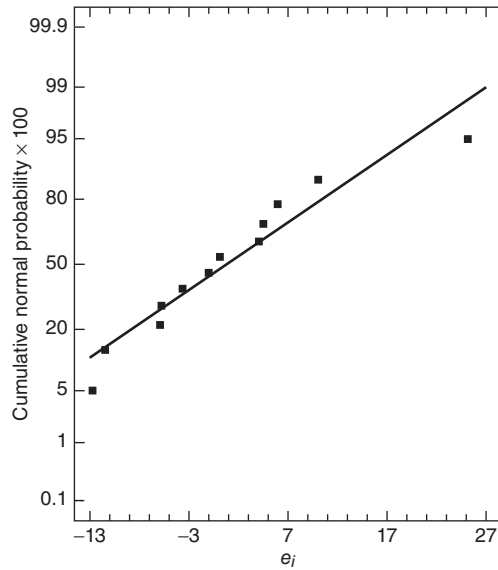

Figure 12.6 Normal probability plot of residuals, Example 12.5.

TABLE 12.3 JMP Output for Fitting the Michaelis–Menten Model to the Puromycin Data

Nonlinear Fit
 Response: Velocity, Predictor: Michaelis Menten Model (2P)

Criterion	Current	Stop Limit
Iteration	13	60
Obj Change	2.001932e-12	1e-15
Relative Gradient	3.5267226e-7	0.000001
Gradient	0.0001344207	0.000001

Parameter	Current Value
theta1	212.68374295
theta2	0.0641212814
SSE	1195.4488144
N	12

Solution

	SSE	DFE	MSE	RMSE
	1195.4488144	10	119.54488	10.933658

Parameter	Estimate	ApproxStdErr
theta1	212.68374295	6.94715515
theta2	0.0641212814	0.00828095

Solved By: Analytic NR

Correlation of Estimates

	theta1	theta2
theta1	1.0000	0.7651
theta2	0.7651	1.0000

where p is the number of parameters in the nonlinear regression model. For the puromycin data in Example 12.5, we found that the residual sum of squares at the final iteration was $S(\hat{\boldsymbol{\theta}}) = 1195$ (also see the JMP output in Table 12.3), so the estimate of σ^2 is

$$\hat{\sigma}^2 = \frac{S(\hat{\boldsymbol{\theta}})}{n-p} = \frac{1195}{12-2} = 119.5$$

We may also estimate the **asymptotic (large-sample) covariance matrix** of the parameter vector $\boldsymbol{\theta}$ by

$$\text{Var}(\hat{\boldsymbol{\theta}}) = \sigma^2 (\mathbf{Z}'\mathbf{Z})^{-1} \quad (12.31)$$

where \mathbf{Z} is the matrix of partial derivatives defined previously, evaluated at the final-iteration least-squares estimate $\hat{\boldsymbol{\theta}}$.

The covariance matrix of the $\hat{\boldsymbol{\theta}}$ vector for the Michaelis–Menten model in Example 12.5 is

$$\text{Var}(\hat{\boldsymbol{\theta}}) = \hat{\sigma}^2 (\mathbf{Z}'\mathbf{Z})^{-1} = 119.5 \begin{bmatrix} 0.4037 & 36.82 \times 10^{-5} \\ 36.82 \times 10^{-5} & 57.36 \times 10^{-8} \end{bmatrix}$$

The main diagonal elements of this matrix are approximate variances of the estimates of the regression coefficients. Therefore, approximate **standard errors** on the coefficients are

$$\text{se}(\hat{\theta}_1) = \sqrt{\text{Var}(\hat{\theta}_1)} = \sqrt{119.5(0.4037)} = 6.95$$

and

$$\text{se}(\hat{\theta}_2) = \sqrt{\text{Var}(\hat{\theta}_2)} = \sqrt{119.5(57.36 \times 10^{-8})} = 8.28 \times 10^{-3}$$

and the correlation between $\hat{\theta}_1$ and $\hat{\theta}_2$ is about

$$\frac{36.82 \times 10^{-5}}{\sqrt{0.4037(57.36 \times 10^{-8})}} = 0.77$$

These values agree closely with those reported in the JMP output, Table 12.3.

Graphical Perspective on Linearization We have observed that the residual-sum-of-squares function $S(\boldsymbol{\theta})$ for a nonlinear regression model is usually an irregular “banana-shaped” function, as shown in panels *b* and *c* of Figure 12.1. On the other hand, the residual-sum-of-squares function for linear least squares is very well behaved; in fact, it is elliptical and has the global minimum at the bottom of the “bowl.” Refer to Figure 12.1*a*. The linearization technique converts the nonlinear regression problem into a sequence of linear ones, starting at the point $\boldsymbol{\theta}_0$.

The first iteration of linearization replaces the irregular contours with a set of elliptical contours. The irregular contours of $S(\boldsymbol{\theta})$ pass exactly through the starting

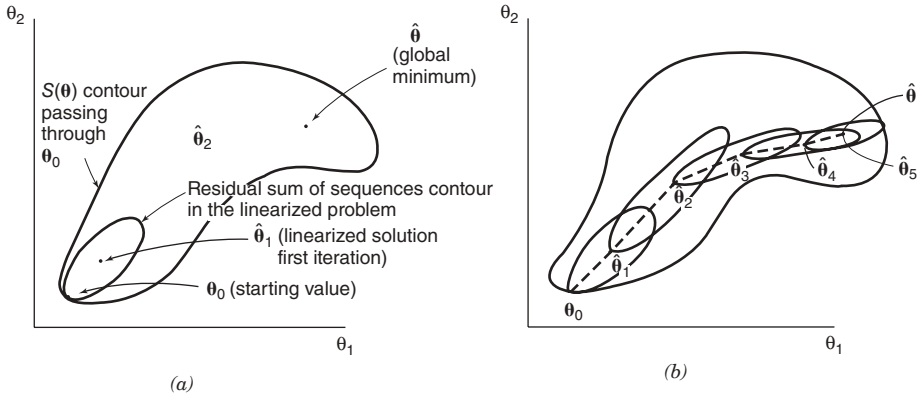

Figure 12.7 A geometric view of linearization: (a) the first iteration; (b) evolution of successive linearization iterations.

point θ_0 , as shown in Figure 12.7a. When we solve the linearized problem, we are moving to the global minimum on the set of elliptical contours. This is done by ordinary linear least squares. Then the next iteration just repeats the process, starting at the new solution $\hat{\theta}_1$. The eventual evolution of linearization is a sequence of linear problems for which the solutions “close in” on the global minimum of the nonlinear function. This is illustrated in Figure 12.7b. Provided that the nonlinear problem is not too ill-conditioned, either because of a poorly specified model or inadequate data, the linearization procedure should converge to a good estimate of the global minimum in a few iterations.

Linearization is facilitated by a good starting value θ_0 , that is, one that is reasonably close to the global minimum. When θ_0 is close to $\hat{\theta}$, the actual residual-sum-of-squares contours of the nonlinear problem are usually well-approximated by the contours of the linearized problem. We will discuss obtaining starting values in Section 12.5.3.

12.5.2 Other Parameter Estimation Methods

The basic linearization method described in Section 12.5.1 may converge very slowly in some problems. In other problems, it may generate a move in the wrong direction, with the residual-sum-of-squares function $S(\hat{\theta}_k)$ actually **increasing** at the k th iteration. In extreme cases, it may fail to converge at all. Consequently, several other techniques for solving the nonlinear regression problem have been developed. Some of them are modifications and refinements of the linearization scheme. In this section we give a brief description of some of these procedures.

Method of Steepest Descent The method of steepest descent attempts to find the global minimum on the residual-sum-of-squares function by direct minimization. The objective is to move from an initial starting point θ_0 in a vector direction with components given by the derivatives of the residual-sum-of-squares function with respect to the elements of θ . Usually these derivatives are estimated by fitting a first-order or planar approximation around the point θ_0 . The regression coefficients in the first-order model are taken as approximations to the first derivatives.

The method of steepest descent is widely used in response surface methodology to move from an initial estimate of the optimum conditions for a process to a region more likely to contain the optimum. The major disadvantage of this method in solving the nonlinear regression problem is that it may converge very slowly. Steepest descent usually works best when the starting point is a long way from the optimum. However, as the current solution gets closer to the optimum, the procedure will produce shorter and shorter moves and a “zig-zag” behavior. This is the convergence problem mentioned previously.

Fractional Increments A standard modification to the linearization technique is the use of **fractional increments**. To describe this method, let $\hat{\beta}_k$ be the standard increment vector in Eq. (12.29) at the k th iteration, but continue to the next iteration only if $S(\hat{\theta}_{k+1}) < S(\hat{\theta}_k)$. If $S(\hat{\theta}_{k+1}) > S(\hat{\theta}_k)$, use $\hat{\beta}_k/2$ as the vector of increments. This halving could be used several times during an iteration, if necessary. If after a specified number of trials a reduction in $S(\hat{\theta}_{k+1})$ is not obtained, the procedure is terminated. The general idea behind this method is to keep the linearization procedure from making a step at any iteration that is too big. The fractional increments technique is helpful when convergence problems are encountered in the basic linearization procedure.

Marquardt’s Compromise Another popular modification to the basic linearization algorithm was developed by Marquardt [1963]. He proposed computing the vector of increments at the k th iteration from

$$(\mathbf{Z}'_k \mathbf{Z}_k + \lambda \mathbf{I}_p) \hat{\beta}_k = \mathbf{Z}'_k (\mathbf{y} - \mathbf{f}_k) \quad (12.32)$$

where $\lambda > 0$. Note the similarity to the ridge regression estimator in Chapter 11. Since the regressor variables are derivatives of the same function, the linearized function invites multicollinearity. Thus, the ridgelike procedure in Eq. (12.32) is intuitively reasonable. Marquardt [1963] used a search procedure to find a value of λ that would reduce the residual sum of squares at each stage.

Different computer programs select λ in different ways. For example, PROC NLIN in SAS begins with $\lambda = 10^{-8}$. A series of trial-and-error computations are done at each iteration with λ repeatedly multiplied by 10 until

$$S(\hat{\theta}_{k+1}) < S(\hat{\theta}_k) \quad (12.33)$$

The procedure also involves reducing λ by a factor of 10 at each iteration as long as Eq. (12.33) is satisfied. The strategy is to keep λ as small as possible while ensuring that the residual sum of squares is reduced at each iteration. This general procedure is often called Marquardt’s compromise, because the resulting vector of increments produced by his method usually lies between the Gauss–Newton vector in the linearization vector and the direction of steepest descent.

12.5.3 Starting Values

Fitting a nonlinear regression model requires starting values θ_0 of the model parameters. Good starting values, that is, values of θ_0 that are close to the true parameter

values, will minimize convergence difficulties. Modifications to the linearization procedure such as Marquardt's compromise have made the procedure less sensitive to the choice of starting values, but it is always a good idea to select θ_0 carefully. A poor choice could cause convergence to a local minimum on the function, and we might be completely unaware that a suboptimal solution has been obtained.

In nonlinear regression models the parameters often have some physical meaning, and this can be very helpful in obtaining starting values. It may also be helpful to plot the expectation function for several values of the parameters to become familiar with the behavior of the model and how changes in the parameter values affect this behavior.

For example, in the Michaelis–Menten function used for the puromycin data, the parameter θ_1 is the asymptotic velocity of the reaction, that is, the maximum value of f as $x \rightarrow \infty$. Similarly, θ_2 represents the half concentration, or the value of x such that when the concentration reaches that value, the velocity is one-half the maximum value. Examining the scatter diagram in Figure 12.2 would suggest that $\theta_1 = 205$ and $\theta_2 = 0.08$ would be reasonable starting values. These values were used in Example 12.5.

In some cases we may transform the expectation function to obtain starting values. For example, the Michaelis–Menten model can be “linearized” by taking the reciprocal of the expectation function. Linear least squares can be used on the reciprocal data, as we did in Example 12.4, resulting in estimates of the linear parameters. These estimates can then be used to obtain the necessary starting values θ_0 . Graphical transformation can also be very effective. A nice example of this is given in Bates and Watts [1988, p. 47].

12.6 STATISTICAL INFERENCE IN NONLINEAR REGRESSION

In a **linear regression model** when the errors are normally and independently distributed, exact statistical tests and confidence intervals based on the t and F distributions are available, and the parameter estimates have useful and attractive statistical properties. However, this is not the case in nonlinear regression, even when the errors are normally and independently distributed. That is, in nonlinear regression the least-squares (or maximum-likelihood) estimates of the model parameters do not enjoy any of the attractive properties that their counterparts do in linear regression, such as unbiasedness, minimum variance, or normal sampling distributions. Statistical inference in nonlinear regression depends on **large-sample** or **asymptotic** results. The large-sample theory generally applies for both normally and nonnormally distributed errors.

The key asymptotic results may be briefly summarized as follows. In general, when the sample size n is large, the expected value of $\hat{\theta}$ is approximately equal to θ , the true vector of parameter estimates, and the covariance matrix of $\hat{\theta}$ is approximately $\sigma^2(\mathbf{Z}'\mathbf{Z})^{-1}$, where \mathbf{Z} is the matrix of partial derivatives evaluated at the final-iteration least-squares estimate $\hat{\theta}$. Furthermore, the sampling distribution of $\hat{\theta}$ is approximately normal. Consequently, statistical inference for nonlinear regression when the sample size is large is carried out exactly as it is for linear regression. The statistical tests and confidence intervals are only approximate procedures.

Example 12.6 The Puromycin Data

Reconsider the Michaelis–Menten model for the puromycin data from Example 12.5. The JMP output for the model is shown in Table 12.3. To test for significance of regression (that is, $H_0: \theta_1 = \theta_2 = 0$) we could use an ANOVA-like procedure. We can compute the total sum of squares of the y 's as $SS_T = 271,909.0$. So the model or regression sum of squares is:

$$\begin{aligned} SS_{\text{model}} &= SS_T - SS_{\text{Res}} \\ &= 271,410 - 1195.4 \\ &= 270,214.6 \end{aligned}$$

Therefore, the test for significance of regression is

$$F_0 = \frac{SS_{\text{model}}/2}{MS_{\text{Error}}} = \frac{270,214.6/2}{119.5} = 1130.61$$

and compute an approximate P value from the $F_{2,10}$ distribution. This P value is considerably less than 0.0001, so we are safe in rejecting the null hypothesis and concluding that at least one of the model parameters is nonzero. To test hypotheses on the individual model parameters, $H_0: \theta_1 = 0$ and $H_0: \theta_2 = 0$, we could compute approximate t statistics as

$$t_0 = \frac{\hat{\theta}_1}{\text{se}(\hat{\theta}_1)} = \frac{212.7}{6.9471} = 30.62$$

and

$$t_0 = \frac{\hat{\theta}_2}{\text{se}(\hat{\theta}_2)} = \frac{0.0641}{0.00828} = 7.74$$

The approximate P values for these two test statistics are both less than 0.01. Therefore, we would conclude that both parameters are nonzero.

Approximate 95% confidence intervals on θ_1 and θ_2 are found as follows:

$$\begin{aligned} \hat{\theta}_1 - t_{0.025,10}\text{se}(\hat{\theta}_1) &\leq \theta_1 \leq \hat{\theta}_1 + t_{0.025,10}\text{se}(\hat{\theta}_1) \\ 212.7 - 2.228(6.9471) &\leq \theta_1 \leq 212.7 + 2.228(6.9471) \\ 197.2 &\leq \theta_1 \leq 228.2 \end{aligned}$$

and

$$\begin{aligned} \hat{\theta}_2 - t_{0.025,10}\text{se}(\hat{\theta}_2) &\leq \theta_2 \leq \hat{\theta}_2 + t_{0.025,10}\text{se}(\hat{\theta}_2) \\ 0.0641 - 2.228(0.00828) &\leq \theta_2 \leq 0.0641 + 2.228(0.00828) \\ 0.0457 &\leq \theta_2 \leq 0.0825 \end{aligned}$$

respectively. In constructing these intervals, we have used the results from the computer output in Table 12.3. Other approximate confidence intervals and prediction intervals would be constructed by inserting the appropriate nonlinear regression quantities into the corresponding equations from linear regression. ■

Validity of Approximate Inference Since the tests, procedures, and confidence intervals in nonlinear regression are based on large-sample theory and typically the sample size in a nonlinear regression problem may not be all that large, it is logical to inquire about the validity of the procedures. It would be desirable to have a guideline or “rule of thumb” that would tell us when the sample size is large enough so that the asymptotic results are valid. Unfortunately, no such general guideline is available. However, there are some **indicators** that the results may be valid in a particular application.

1. If the nonlinear regression estimation algorithm converges in only a few iterations, then this indicates that the linear approximation used in solving the problem was very satisfactory, and it is likely that the asymptotic results will apply nicely. Convergence requiring many iterations is a symptom that the asymptotic results may not apply, and other adequacy checks should be considered.
2. Several measures of model curvature and nonlinearity have been developed. This is discussed by Bates and Watts [1988]. These measures describe quantitatively the adequacy of the linear approximation. Once again, an inadequate linear approximation would indicate that the asymptotic inference results are questionable.
3. In Chapter 15 will illustrate a resampling technique called the **bootstrap** that can be used to study the sampling distribution of estimators, to compute approximate standard errors, and to find approximate confidence intervals. We could compute bootstrap estimates of these quantities and compare them to the approximate standard errors and confidence intervals produced by the asymptotic results. Good agreement with the bootstrap estimates is an indication that the large-sample inference results are valid.

When there is some indication that the asymptotic inference results are not valid, the model-builder has few choices. One possibility is to consider an alternate form of the model, if one exists, or perhaps a different nonlinear regression model. Sometimes, graphs of the data and graphs of different nonlinear model expectation functions may be helpful in this regard. Alternatively, one may use the inference results from resampling or the bootstrap. However, if the model is wrong or poorly specified, there is little reason to believe that resampling results will be any more valid than the results from large-sample inference.

12.7 EXAMPLES OF NONLINEAR REGRESSION MODELS

Ideally a nonlinear regression model is chosen based on **theoretical considerations** from the subject-matter field. That is, specific chemical, physical, or biological knowledge leads to a **mechanistic model** for the expectation function rather than an

empirical one. Many nonlinear regression models fall into categories designed for specific situations or environments. In this section we discuss a few of these models.

Perhaps the best known category of nonlinear models are **growth models**. These models are used to describe how something grows with changes in a regressor variable. Often the regressor variable is time. Typical applications are in biology, where plants and organisms grow with time, but there are also many applications in economics and engineering. For example, the reliability growth in a complex system over time may often be described with a nonlinear regression model.

The **logistic** growth model is

$$y = \frac{\theta_1}{1 + \theta_2 \exp(-\theta_3 x)} + \varepsilon \quad (12.34)$$

The parameters in this model have a simple physical interpretation. For $x = 0$, $y = \theta_1 / (1 + \theta_2)$ is the level of y at time (or level) zero. The parameter θ_1 is the limit to growth as $x \rightarrow \infty$. The values of θ_2 and θ_3 must be positive. Also, the term $-\theta_3 x$ in the denominator exponent of Eq. (12.34) could be replaced by a more general structure in several regressors. The logistic growth model is essentially the model given by Eq. (12.7) derived in Example (12.1).

The **Gompertz** model given by

$$y = \theta_1 \exp(-\theta_2 e^{-\theta_3 x}) + \varepsilon \quad (12.35)$$

is another widely used growth model. At $x = 0$ we have $y = \theta_1 e^{-\theta_2}$ and θ_1 is the limit to growth as $x \rightarrow \infty$.

The **Weibull** growth model is

$$y = \theta_1 - \theta_2 \exp(-\theta_3 x^{\theta_4}) + \varepsilon \quad (12.36)$$

When $x = 0$, we have $y = \theta_1 - \theta_2$, while the limiting growth is θ_1 as $x \rightarrow \infty$.

In some applications the expected response is given by the solution to a set of linear differential equations. These models are often called **compartment models**, and since chemical reactions can frequently be described by linear systems of first-order differential equations, they have frequent application in chemistry, chemical engineering, and pharmacokinetics. Other situations specify the expectation function as the solution to a nonlinear differential equation or an integral equation that has no analytic solution. There are special techniques for the modeling and solution of these problems. The interested reader is referred to Bates and Watts [1988].

12.8 USING SAS AND R

SAS developed PROC NLIN to perform nonlinear regression analysis. Table 12.4 gives the source code to analyze the puromycin data introduced in Example 12.4. The statement PROC NLIN tells the software that we wish to perform a nonlinear regression analysis. By default, SAS uses the Gauss–Newton method to find the parameter estimates. If the Gauss–Newton method has problems converging to final estimates, we suggest using Marquardt’s compromise. The appropriate SAS command to request the Marquardt compromise is

TABLE 12.4 SAS Code for Puromycin Data Set

```

data puromycin;
input x y;
cards;
0.02 76
0.02 47
0.06 97
0.06 107
0.11 123
0.11 139
0.22 159
0.22 152
0.56 191
0.56 201
1.10 207
1.10 200
proc nlin;
  parms t1 = 195.81
        t2 = 0.04841;
  model y = t1*x/ (t2 + x);
  der.t1 = x/ (t2 + x);
  der.t2 = -t1*x/ ((t2 + x) * (t2 + x));
  output out = puro2 student = rs p = yp;
run;
goptions device = win hsize = 6 vsize = 6;
  symbol value = star;
proc gplot data = puro2;
  plot rs*yp rs*x;
  plot y*x= " * " yp*x= " + " /overlay;
run;
proc capability data = puro2;
  var rs;
  qqplot rs;
run;

```

```
proc nlin method = marquardt;
```

The parms statement specifies the names for the unknown parameters and gives the starting values for the parameter estimates. We highly recommend the use of specific starting values for the estimation procedure, especially if we can linearize the expectation function. In this particular example, we have used the solutions for the estimated parameters found in Example 12.2 when we linearized the model. SAS allows a grid search as an alternative. Please see the SAS help menu for more details. The following statement illustrates how to initiate a grid search in SAS for the puromycin data:

```
parms t1 = 190 to 200 by 1
      t2 = 0.04 to 0.05 by .01;
```

The model statement gives the specific model. Often, our nonlinear models are sufficiently complicated that it is useful to define new variables to simplify the model expression. The Michaelis–Menten model is simple enough that we do not require new variables. However, the following statements illustrate how we could define these variables. *These statements must come between the parms and model statements.*

```
denom = X + t2;
model y = t1*x/denom;
```

The two statements that begin with `der.` are the derivatives of the expectation function with regard to the unknown parameters. `der.t1` is the derivative with respect to θ_1 , and `der.t2` is the derivative with respect to θ_2 . We can specify these derivatives using any variables that we had defined in order to simplify the expression of the model. We highly recommend specifying these derivatives because the efficiency of the estimation algorithm often depends heavily upon this information. SAS does not require the derivative information; however, we strongly recommend it.

The output statement tells SAS what information we wish to add to the original puromycin data set. In this example, we add residual information so that we can create “nice” residual plots. The portion `out = puro2` names the resulting data set `puro2`. The portion `student = rs` tells SAS to add the studentized residuals to `puro2` and call them `rs`. Similarly, the portion `p = yp` tells SAS to add the predicted values and call them `yp`. See both Appendix D.4 and the SAS help menu for more background on the output statement.

The remainder of the code is very similar to the code used to generate nice residual plots for linear regression that we illustrated in Section 4.2.3. This section of code produces the residual-versus-predicted-value plot, the residual-versus-regressor plot, an overlay of the original data and the predicted values, and a normal probability plot of the residuals. These plots are not shown. An annotated version of the resulting SAS output file is given in Table 12.5. We only want the normal probability plot of the residuals from the PROC CAPABILITY analysis.

We now outline the appropriate R code to analyze the puromycin data. This analysis assumes that the data are in a file named “puromycin.txt.” The R code to read the data into the package is:

```
puro <- read.table("puromycin.txt",header=TRUE, sep=" ")
```

The object `puro` is the R data set. The commands

```
puro.model<-nls(y~t1*x/(t2+x),start=list(t1=205,t2=.08),data
=puro)
summary(puro.model)
```

tell R to estimate the model and to print the estimated coefficients and their tests. The commands

```
yhat <- fitted(puro.model)
e <- residuals(trans.model)
```

TABLE 12.5 SAS Output for Purtomycin Data

The NLIN Procedure
 Dependent Variable y
 Method: Gauss-Newton

Iterative Phase

Iter	t1	t2	Sum of Squares
0	195.8	0.0484	1920.0
1	210.9	0.0614	1207.0
2	212.5	0.0638	1195.6
3	212.7	0.0641	1195.5
4	212.7	0.0641	1195.4
5	212.7	0.0641	1195.4

NOTE: Convergence criterion met.
 Estimation Summary

Method	Gauss-Newton
Iterations	5
R	9.867E-6
PPC(t2)	4.03E-6
RPC(t2)	0.000042
Object	1.149E-8
Objective	1195.449
Observations Read	12
Observations Used	12
Observations Missing	0

NOTE: An intercept was not specified for this model.

Source	DF	Sum of Squares	Mean Square	F Value	Approx Pr > F
Model	2	270214	135107	1130.18	<.0001
Error	10	1195.4	119.5		
Uncorrected Total	12	271409			

Parameter	Estimate	Approx Std Error	Approximate 95% Confidence Limits
t1	212.7	6.9471	197.2 228.2
t2	0.0641	0.00828	0.0457 0.0826

The SAS System 2
 The NLIN Procedure
 Approximate Correlation Matrix

	t1	t2
t1	1.0000000	0.7650834
t2	0.7650834	1.0000000

```
qqnorm(e)
plot(yhat, e)
plot(puro$x, t)
```

set up and then create the appropriate residual plots. The commands

```
puro2 <- cbind(puro, yhat, e)
write.table(puro2, "puromycin_output.txt")
```

create a file “puromycin_output.txt” which the user than can import into his/her favorite package for doing graphics.

PROBLEMS

- 12.1** Consider the Michaelis–Menten model introduced in Eq. (12.23). Graph the expectation function for this model for $\theta_1 = 200$ and $\theta_2 = 0.04, 0.06, 0.08, 0.10$. Overlay these curves on the same set of x – y axes. What effect does the parameter θ_2 have on the behavior of the expectation function?
- 12.2** Consider the Michaelis–Menten model introduced in Eq. (12.23). Graph the expectation function for $\theta_1 = 100, 150, 200, 250$ for $\theta_2 = 0.06$. Overlay these curves on the same set of x – y axes. What effect does the parameter θ_1 have on the behavior of the expectation function?
- 12.3** Graph the expectation function for the logistic growth model (12.34) for $\theta_1 = 10$, $\theta_2 = 2$, and values of $\theta_3 = 0.25, 1, 2, 3$, respectively. Overlay these plots on the same set of x – y axes. What effect does the parameter θ_3 have on the expectation function?
- 12.4** Sketch the expectation function for the logistic growth model (12.34) for $\theta_1 = 1$, $\theta_3 = 1$, and values of $\theta_2 = 1, 4, 8$, respectively. Overlay these plots on the same x – y axes. Discuss the effect of θ_2 on the shape of the function.
- 12.5** Consider the Gompertz model in Eq. (12.35). Graph the expectation function for $\theta_1 = 1$, $\theta_3 = 1$, and $\theta_2 = \frac{1}{8}, 1, 8, 64$ over the range $0 \leq x \leq 10$.
- Discuss the behavior of the model as a function of θ_2 .
 - Discuss the behavior of the model as $x \rightarrow \infty$.
 - What is $E(y)$ when $x = 0$?
- 12.6** For the models shown below, determine whether it is a linear model, an intrinsically linear model, or a nonlinear model. If the model is intrinsically linear, show how it can be linearized by a suitable transformation.
- $y = \theta_1 e^{\theta_2 + \theta_3 x} + \varepsilon$
 - $y = \theta_1 + \theta_2 x_1 + \theta_2 x_2^{\theta_3} + \varepsilon$
 - $y = \theta_1 + \theta_2 / \theta_1 x + \varepsilon$
 - $\theta_1 (x_1)^{\theta_2} (x_2)^{\theta_3} + \varepsilon$
 - $\theta_1 + \theta_2 e^{\theta_3 x} + \varepsilon$

12.7 Reconsider the regression models in Problem 12.6, parts a–e. Suppose the error terms in these models were multiplicative, not additive. Rework the problem under this new assumption regarding the error structure.

12.8 Consider the following observations:

x	y	
0.5	0.68	1.58
1	0.45	2.66
2	2.50	2.04
4	6.19	7.85
8	56.1	54.2
9	89.8	90.2
10	147.7	146.3

a. Fit the nonlinear regression model

$$y = \theta_1 e^{\theta_2 x} + \varepsilon$$

to these data. Discuss how you obtained the starting values.

b. Test for significance of regression.

c. Estimate the error variance σ^2 .

d. Test the hypotheses $H_0: \theta_1 = 0$ and $H_0: \theta_2 = 0$. Are both model parameters different from zero? If not, refit an appropriate model.

e. Analyze the residuals from this model. Discuss model adequacy.

12.9 Reconsider the data in the previous problem. The response measurements in the two columns were collected on two different days. Fit a new model

$$y = \theta_3 x_2 + \theta_1 e^{\theta_2 x_1} + \varepsilon$$

to these data, where x_1 is the original regressor from Problem 12.8 and x_2 is an indicator variable with $x_2 = 0$ if the observation was made on day 1 and $x_2 = 1$ if the observation was made on day 2. Is there any indication that there is a difference between the two days (use $\theta_3 = 0$ as the starting value).

12.10 Consider the model

$$y = \theta_1 - \theta_2 e^{-\theta_3 x} + \varepsilon$$

This is called the Mitcherlich equation, and it is often used in chemical engineering. For example, y may be yield and x may be reaction time.

a. Is this a nonlinear regression model?

b. Discuss how you would obtain reasonable starting values of the parameters θ_1 , θ_2 , and θ_3 .

c. Graph the expectation function for the parameter values $\theta_1 = 0.5$, $\theta_2 = -0.10$, and $\theta_3 = 0.10$. Discuss the shape of the function.

d. Graph the expectation function for the parameter values $\theta_1 = 0.5$, $\theta_2 = 0.10$, and $\theta_3 = 0.10$. Compare the shape with the one obtained in part c.

- 12.11** The data below represent the fraction of active chlorine in a chemical product as a function of time after manufacturing.

Available Chlorine, y_i	Time, x_i
0.49, 0.49	8
0.48, 0.47, 0.48, 0.47	10
0.46, 0.46, 0.45, 0.43	12
0.45, 0.43, 0.43	14
0.44, 0.43, 0.43	16
0.46, 0.45	18
0.42, 0.42, 0.43	20
0.41, 0.41, 0.40	22
0.42, 0.40, 0.40	24
0.41, 0.40, 0.41	26
0.41, 0.40	28
0.40, 0.40, 0.38	30
0.41, 0.40	32
0.40	34
0.41, 0.38	36
0.40, 0.40	38
0.39	40
0.39	42

- Construct a scatterplot of the data.
 - Fit the Mitcherlich law (see Problem 12.10) to these data. Discuss how you obtained the starting values.
 - Test for significance of regression.
 - Find approximate 95% confidence intervals on the parameters θ_1 , θ_2 , and θ_3 . Is there evidence to support the claim that all three parameters are different from zero?
 - Analyze the residuals and comment on model adequacy.
- 12.12** Consider the data below.

		x_2		
		50	75	100
2	x_1	4.70	5.52	3.98
		2.68	3.75	4.22
4	x_1	6.35	5.88	6.28
		6.10	7.69	7.12
6	x_1	7.85	9.00	11.43
		9.25	9.78	9.62

These data were collected in an experiment where x_1 = reaction time in minutes and x_2 = temperature in degrees Celsius. The response variable y is concentration (grams per liter). The engineer is considering the model

$$y = \theta_1 (x_1)^{\theta_2} (x_2)^{\theta_3} + \varepsilon$$

- a. Note that we can linearize the expectation function by taking logarithms. Fit the resulting linear regression model to the data.
- b. Test for significance of regression. Does it appear that both variables x_1 and x_2 have important effects?
- c. Analyze the residuals and comment on model adequacy.

12.13 Continuation of Problem 12.12

- a. Fit the nonlinear model given in Problem 12.12 using the solution you obtained by linearizing the expectation function as the starting values.
- b. Test for significance of regression. Does it appear that both variables x_1 and x_2 have important effects?
- c. Analyze the residuals and comment on model adequacy.
- d. Which model do you prefer, the nonlinear model or the linear model from Problem 12.12?

12.14 Continuation of Problem 12.12. The two observations in each cell of the data table in Problem 12.12 are two replicates of the experiment. Each replicate was run from a unique batch of raw material. Fit the model

$$y = \theta_4 x_3 + \theta_1 (x_1)^{\theta_2} (x_2)^{\theta_3} + \varepsilon$$

where $x_3 = 0$ if the observation comes from replicate 1 and $x_3 = 1$ if the observation comes from replicate 2. Is there an indication of a difference between the two batches of raw material?

12.15 The following table gives the vapor pressure of water for various temperatures, previously reported in Exercise 5.2.

Temperature ($^{\circ}$ K)	Vapor Pressure (mm Hg)
273	4.6
283	9.2
293	17.5
303	31.8
313	55.3
323	92.5
333	149.4
343	233.7
353	355.1
363	525.8
373	760.0

- a. Plot a scatter diagram. Does it seem likely that a straight-line model will be adequate?
- b. Fit the straight-line model. Compute the summary statistics and the residual plots. What are your conclusions regarding model adequacy?
- c. From physical chemistry the Clausius–Clapeyron equation states that

$$\ln(p_v) \propto -\frac{1}{T}$$

Repeat part b using the appropriate transformation based on this information.

- d. Fit the appropriate non-linear model.
- e. Discuss the differences in these models. Discuss which model you prefer.

12.16 The following data were collected on specific gravity and spectrophotometer analysis for 26 mixtures of NG (nitroglycerine), TA (triacetin), and 2 NDPA (2-nitrodiphenylamine).

Mixture	x_1 (% NG)	x_2 (% TA)	x_3 (% 2 NDPA)	y (Specific Gravity)
1	79.98	19.85	0	1.4774
2	80.06	18.91	1.00	1.4807
3	80.10	16.87	3.00	1.4829
4	77.61	22.36	0	1.4664
5	77.60	21.38	1.00	1.4677
6	77.63	20.35	2.00	1.4686
7	77.34	19.65	2.99	1.4684
8	75.02	24.96	0	1.4524
9	75.03	23.95	1.00	1.4537
10	74.99	22.99	2.00	1.4549
11	74.98	22.00	3.00	1.4565
12	72.50	27.47	0	1.4410
13	72.50	26.48	1.00	1.4414
14	72.50	25.48	2.00	1.4426
15	72.49	24.49	3.00	1.4438
16	69.98	29.99	0	1.4279
17	69.98	29.00	1.00	1.4287
18	69.99	27.99	2.00	1.4291
19	69.99	26.99	3.00	1.4301
20	67.51	32.47	0	1.4157
21	67.50	31.47	1.00	1.4172
22	67.48	30.50	2.00	1.4183
23	67.49	29.49	3.00	1.4188
24	64.98	34.00	1.00	1.4042
25	64.98	33.00	2.00	1.4060
26	64.99	31.99	3.00	1.4068

Source: Raymond H. Myers, *Technometrics*, vol. 6, no. 4 (November 1964): 343–356.

There is a need to estimate activity coefficients from the model

$$y = \frac{1}{\beta_1 x_1 + \beta_2 x_2 + \beta_3 x_3} = \varepsilon$$

The quantity parameters β_1 , β_2 , and β_3 are ratios of activity coefficients to the individual specific gravity of the NG, TA, and 2 NDPA, respectively.

- a. Determine starting values for the model parameters.
- b. Use nonlinear regression to fit the model.
- c. Investigate the adequacy of the nonlinear model.

CHAPTER 13

GENERALIZED LINEAR MODELS

13.1 INTRODUCTION

In Chapter 5, we developed and illustrated data transformation as an approach to fitting regression models when the assumptions of a normally distributed response variable with constant variance are not appropriate. Transformation of the response variable is often a very effective way to deal with both response nonnormality and inequality of variance. Weighted least squares is also a potentially useful way to handle the non-constant variance problem. In this chapter, we present an alternative approach to data transformation when the “usual” assumptions of normality and constant variance are not satisfied. This approach is based on the **generalized linear model (GLM)**.

The GLM is a unification of both linear and nonlinear regression models that also allows the incorporation of nonnormal response distributions. In a GLM, the response variable distribution must only be a member of the **exponential family**, which includes the normal, Poisson, binomial, exponential, and gamma distributions as members. Furthermore, the normal-error linear model is just a special case of the GLM, so in many ways, the GLM can be thought of as a unifying approach to many aspects of empirical modeling and data analysis.

We begin our presentation of these models by considering the case of **logistic regression**. This is a situation where the response variable has only two possible outcomes, generically called success and failure and denoted by 0 and 1. Notice that the response is essentially qualitative, since the designation success or failure is entirely arbitrary. Then we consider the situation where the response variable is a count, such as the number of defects in a unit of product or the number of relatively

rare events such as the number of Atlantic hurricanes that make landfall on the United States in a year. Finally, we discuss how all these situations are unified by the GLM. For more details of the GLM, refer to Myers, Montgomery, Vining, and Robinson [2010].

13.2 LOGISTIC REGRESSION MODELS

13.2.1 Models with a Binary Response Variable

Consider the situation where the response variable in a regression problem takes on only two possible values, 0 and 1. These could be arbitrary assignments resulting from observing a qualitative response. For example, the response could be the outcome of a functional electrical test on a semiconductor device for which the results are either a success, which means the device works properly, or a failure, which could be due to a short, an open, or some other functional problem.

Suppose that the model has the form

$$y_i = \mathbf{x}'_i \boldsymbol{\beta} + \varepsilon_i \quad (13.1)$$

where $\mathbf{x}'_i = [1, x_{i1}, x_{i2}, \dots, x_{ik}]$, $\boldsymbol{\beta} = [\beta_0, \beta_1, \beta_2, \dots, \beta_k]$, and the response variable y_i takes on the value either 0 or 1. We will assume that the response variable y_i is a **Bernoulli random variable** with probability distribution as follows:

y_i	Probability
1	$P(y_i = 1) = \pi_i$
0	$P(y_i = 0) = 1 - \pi_i$

Now since $E(\varepsilon_i) = 0$, the expected value of the response variable is

$$E(y_i) = 1(\pi_i) + 0(1 - \pi_i) = \pi_i$$

This implies that

$$E(y_i) = \mathbf{x}'_i \boldsymbol{\beta} = \pi_i$$

This means that the expected response given by the response function $E(y_i) = \mathbf{x}'_i \boldsymbol{\beta}$ is just the probability that the response variable takes on the value 1.

There are some very basic problems with the regression model in Eq. (13.1). First, note that if the response is binary, then the error terms ε_i can only take on two values, namely,

$$\varepsilon_i = 1 - \mathbf{x}'_i \boldsymbol{\beta} \quad \text{when } y_i = 1$$

$$\varepsilon_i = -\mathbf{x}'_i \boldsymbol{\beta} \quad \text{when } y_i = 0$$

Consequently, the errors in this model cannot possibly be normal. Second, the error variance is not constant, since

$$\sigma_{y_i}^2 = E\{y_i - E(y_i)\}^2 = (1 - \pi_i)^2 \pi_i + (0 - \pi_i)^2 (1 - \pi_i) = \pi_i (1 - \pi_i)$$

Notice that this last expression is just

$$\sigma_{y_i}^2 = E(y_i)[1 - E(y_i)]$$

since $E(y_i) = \mathbf{x}'_i \boldsymbol{\beta} = \pi_i$. This indicates that the variance of the observations (which is the same as the variance of the errors because $\varepsilon_i = y_i - \pi_i$, and π_i is a constant) is a function of the mean. Finally, there is a constraint on the response function, because

$$0 \leq E(y_i) = \pi_i \leq 1$$

This restriction can cause serious problems with the choice of a **linear response function**, as we have initially assumed in Eq. (13.1). It would be possible to fit a model to the data for which the predicted values of the response lie outside the 0, 1 interval.

Generally, when the response variable is binary, there is considerable empirical evidence indicating that the shape of the response function should be nonlinear. A monotonically increasing (or decreasing) S-shaped (or reverse S-shaped) function, such as shown in Figure 13.1, is usually employed. This function is called the **logistic response function** and has the form

$$E(y) = \frac{\exp(\mathbf{x}'\boldsymbol{\beta})}{1 + \exp(\mathbf{x}'\boldsymbol{\beta})} = \frac{1}{1 + \exp(-\mathbf{x}'\boldsymbol{\beta})} \quad (13.2)$$

The logistic response function can be easily linearized. One approach defines the structural portion of the model in terms of a function of the response function mean. Let

$$\eta = \mathbf{x}'\boldsymbol{\beta} \quad (13.3)$$

be the **linear predictor** where η is defined by the transformation

$$\eta = \ln \frac{\pi}{1 - \pi} \quad (13.4)$$

This transformation is often called the **logit transformation** of the probability π , and the ratio $\pi/(1 - \pi)$ in the transformation is called the **odds**. Sometimes the logit transformation is called the log-odds.

13.2.2 Estimating the Parameters in a Logistic Regression Model

The general form of the logistic regression model is

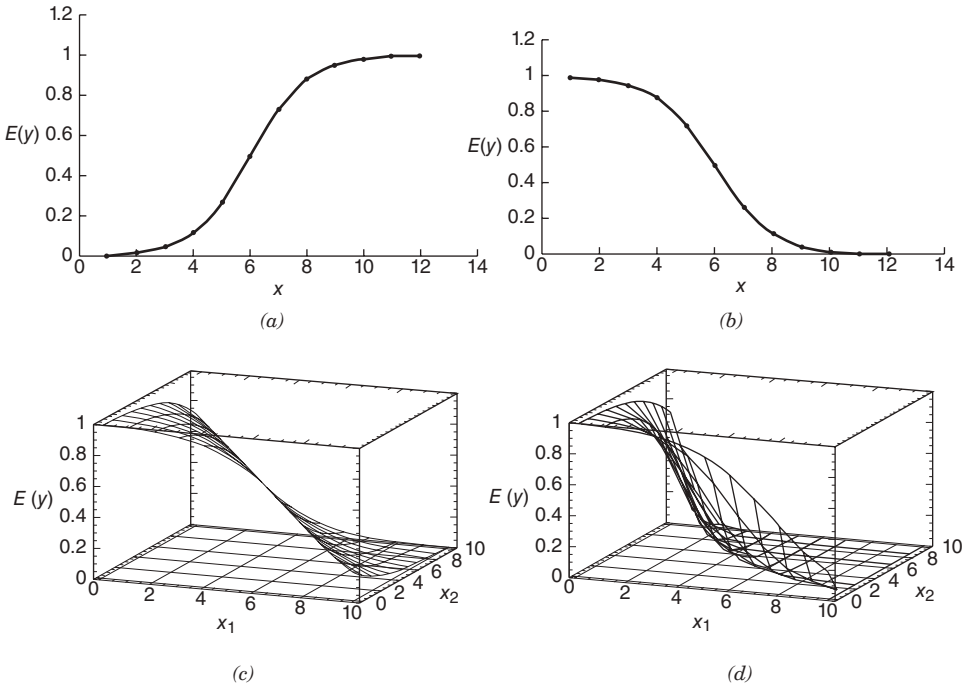

Figure 13.1 Examples of the logistic response function: (a) $E(y) = 1/(1 + e^{-6.0 + 1.0x})$; (b) $E(y) = 1/(1 + e^{-6.0 + 1.0x})$; (c) $E(y) = 1/(1 + e^{-5.0 + 0.65x_1 + 0.4x_2})$; (d) $E(y) = 1/(1 + e^{-5.0 + 0.65x_1 + 0.4x_2 + 0.15x_1x_2})$.

$$y_i = E(y_i) + \varepsilon_i \tag{13.5}$$

where the observations y_i are independent Bernoulli random variables with expected values

$$E(y_i) = \pi_i = \frac{\exp(\mathbf{x}'_i\boldsymbol{\beta})}{1 + \exp(\mathbf{x}'_i\boldsymbol{\beta})} \tag{13.6}$$

We use the method of **maximum likelihood** to estimate the parameters in the linear predictor $\mathbf{x}'_i\boldsymbol{\beta}$.

Each sample observation follows the Bernoulli distribution, so the probability distribution of each sample observation is

$$f_i(y_i) = \pi_i^{y_i} (1 - \pi_i)^{1 - y_i}, \quad i = 1, 2, \dots, n$$

and of course each observation y_i takes on the value 0 or 1. Since the observations are independent, the likelihood function is just

$$L(y_1, y_2, \dots, y_n, \boldsymbol{\beta}) = \prod_{i=1}^n f_i(y_i) = \prod_{i=1}^n \pi_i^{y_i} (1 - \pi_i)^{1 - y_i} \tag{13.7}$$

It is more convenient to work with the log-likelihood

$$\begin{aligned} \ln L(y_1, y_2, \dots, y_n, \boldsymbol{\beta}) &= \ln \prod_{i=1}^n f_i(y_i) \\ &= \sum_{i=1}^n \left[y_i \ln \left(\frac{\pi_i}{1-\pi_i} \right) \right] + \sum_{i=1}^n \ln(1-\pi_i) \end{aligned}$$

Now since $1-\pi_i = [1 + \exp(\mathbf{x}'_i\boldsymbol{\beta})]^{-1}$ and $\eta_i = \ln[\pi_i / (1-\pi_i)] = \mathbf{x}'_i\boldsymbol{\beta}$, the log-likelihood can be written as

$$\ln L(\mathbf{y}, \boldsymbol{\beta}) = \sum_{i=1}^n y_i \mathbf{x}'_i \boldsymbol{\beta} - \sum_{i=1}^n \ln[1 + \exp(\mathbf{x}'_i \boldsymbol{\beta})] \tag{13.8}$$

Often in logistic regression models we have repeated observations or trials at each level of the x variables. This happens frequently in designed experiments. Let y_i represent the number of 1's observed for the i th observation and n_i be the number of trials at each observation. Then the log-likelihood becomes

$$\begin{aligned} \ln L(\mathbf{y}, \boldsymbol{\beta}) &= \sum_{i=1}^n y_i \ln(\pi_i) + \sum_{i=1}^n n_i \ln(1-\pi_i) - \sum_{i=1}^n y_i \ln(1-\pi_i) \\ &= \sum_{i=1}^n y_i \ln(\pi_i) + \sum_{i=1}^n (n_i - y_i) \ln(1-\pi_i) \end{aligned} \tag{13.9}$$

Numerical search methods could be used to compute the maximum-likelihood estimates (or MLEs) $\hat{\boldsymbol{\beta}}$. However, it turns out that we can use iteratively reweighted least squares (IRLS) to actually find the MLEs. For details of this procedure, refer to Appendix C.14. There are several excellent computer programs that implement maximum-likelihood estimation for the logistic regression model, such as SAS PROC GENMOD, JMP and Minitab.

Let $\hat{\boldsymbol{\beta}}$ be the final estimate of the model parameters that the above algorithm produces. If the model assumptions are correct, then we can show that asymptotically

$$E(\hat{\boldsymbol{\beta}}) = \boldsymbol{\beta} \quad \text{and} \quad \text{Var}(\hat{\boldsymbol{\beta}}) = (\mathbf{X}'\mathbf{V}\mathbf{X})^{-1} \tag{13.10}$$

where the matrix \mathbf{V} is an $n \times n$ diagonal matrix containing the estimated variance of each observation on the main diagonal; that is, the i th diagonal element of \mathbf{V} is

$$V_{ii} = n_i \hat{\pi}_i (1 - \hat{\pi}_i)$$

The estimated value of the linear predictor is $\hat{\eta}_i = \mathbf{x}'_i \hat{\boldsymbol{\beta}}$, and the fitted value of the logistic regression model is written as

$$\hat{y}_i = \hat{\pi}_i = \frac{\exp(\hat{\eta}_i)}{1 + \exp(\hat{\eta}_i)} = \frac{\exp(\mathbf{x}'_i \hat{\boldsymbol{\beta}})}{1 + \exp(\mathbf{x}'_i \hat{\boldsymbol{\beta}})} = \frac{1}{1 + \exp(-\mathbf{x}'_i \hat{\boldsymbol{\beta}})} \tag{13.11}$$

Example 13.1 The Pneumoconiosis Data

A 1959 article in the journal *Biometrics* presents data concerning the proportion of coal miners who exhibit symptoms of severe pneumoconiosis and the number of years of exposure. The data are shown in Table 13.1. The response variable of interest, y , is the proportion of miners who have severe symptoms. A graph of the response variable versus the number of years of exposure is shown in Figure 13.2. A reasonable probability model for the number of severe cases is the binomial, so we will fit a logistic regression model to the data.

Table 13.2 contains some of the output from Minitab. In subsequent sections, we will discuss in more detail the information contained in this output. The section of the output entitled Logistic Regression Table presents the estimates of the regression coefficients in the linear predictor.

The fitted logistic regression model is

$$\hat{y} = \hat{\pi} = \frac{1}{1 + e^{+4.7965 - 0.0935x}}$$

where x is the number of years of exposure. Figure 13.3 presents a plot of the fitted values from this model superimposed on the scatter diagram of the sample data. The logistic regression model seems to provide a reasonable fit to the sample data. If we let CASES be the number of severe cases and MINERS be the number of miners the appropriate SAS code to analyze these data is

```
proc genmod;
model CASES = MINERS / dist = binomial type1 type3;
```

Minitab will also calculate and display the covariance matrix of the model parameters. For the model of the pneumoconiosis data, the covariance matrix is

$$\text{Var}(\hat{\beta}) = \begin{bmatrix} 0.323283 & -0.0083480 \\ -0.0083480 & 0.0002380 \end{bmatrix}$$

The standard errors of the model parameter estimates reported in Table 13.2 are the square roots of the main diagonal elements of this matrix. ■

TABLE 13.1 The Pneumoconiosis Data

Number of Years of Exposure	Number of Severe Cases	Total Number of Miners	Proportion of Severe Cases, y
5.8	0	98	0
15.0	1	54	0.0185
21.5	3	43	0.0698
27.5	8	48	0.1667
33.5	9	51	0.1765
39.5	8	38	0.2105
46.0	10	28	0.3571
51.5	5	11	0.4545

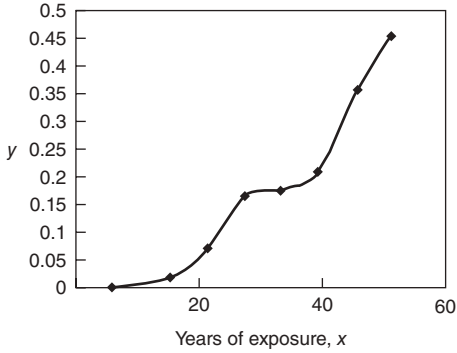

Figure 13.2 A scatter diagram of the pneumoconiosis data from Table 13.1.

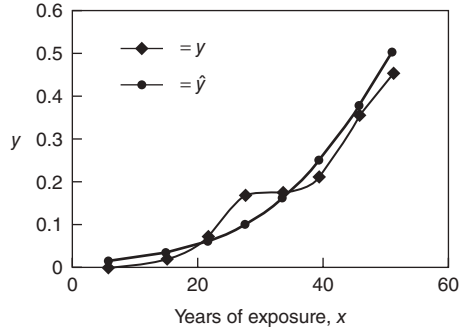

Figure 13.3 The fitted logistic regression model for pneumoconiosis data from Table 13.1.

TABLE 13.2 Binary Logistic Regression: Severe Cases, Number of Miners versus Years

Link Function Logit

Response Information

Variable	Value	Count
Severe cases	Success	44
	Failure	327
Number of miners	Total	371

Logistic Regression Table

Predictor	Coef	SE Coef	Z	P	Odds Ratio	95% Lower	95% Upper	CI
Constant	-4.79648	0.568580	-8.44					
Years	0.0934629	0.0154258	6.06	0.000	1.10	1.07	1.13	

Log- Likelihood = -109.664

Test that all slopes are zero: G = 50.852, DF = 1, P-Value = 0.000

Goodness-of-Fit Tests

Method	Chi-Square	DF	P
Pearson	5.02854	6	0.540
Deviance	6.05077	6	0.418
Hosmer-Lemeshow	5.00360	5	0.415

Table of Observed and Expected Frequencies:

(See Hosmer-Lemeshow Test for the Pearson Chi-Square Statistic)

Value	Group							Total
	1	2	3	4	5	6	7	
Success								
Obs	0	1	3	8	9	8	15	44
Exp	1.4	1.8	2.5	4.7	8.1	9.5	16.1	
Failure								
Obs	98	53	40	40	42	30	24	327
Exp	96.6	52.2	40.5	43.3	42.9	28.5	22.9	
Total	98	54	43	48	51	38	39	371

13.2.3 Interpretation of the Parameters in a Logistic Regression Model

It is relatively easy to interpret the parameters in a logistic regression model. Consider first the case where the linear predictor has only a single regressor, so that the fitted value of the linear predictor at a particular value of x , say x_i , is

$$\hat{\eta}(x_i) = \hat{\beta}_0 + \hat{\beta}_1 x_i$$

The fitted value at $x_i + 1$ is

$$\hat{\eta}(x_i + 1) = \hat{\beta}_0 + \hat{\beta}_1 (x_i + 1)$$

and the difference in the two predicted values is

$$\hat{\eta}(x_i + 1) - \hat{\eta}(x_i) = \hat{\beta}_1$$

Now $\hat{\eta}(x_i)$ is just the log-odds when the regressor variable is equal to x_i , and $\hat{\eta}(x_i + 1)$ is just the log-odds when the regressor is equal to $x_i + 1$. Therefore, the difference in the two fitted values is

$$\begin{aligned} \hat{\eta}(x_i + 1) - \hat{\eta}(x_i) &= \ln(\text{odds}_{x_i+1}) - \ln(\text{odds}_{x_i}) \\ &= \ln\left(\frac{\text{odds}_{x_i+1}}{\text{odds}_{x_i}}\right) = \hat{\beta}_1 \end{aligned}$$

If we take antilogs, we obtain the **odds ratio**

$$\hat{O}_R = \frac{\text{odds}_{x_i+1}}{\text{odds}_{x_i}} = e^{\hat{\beta}_1} \quad (13.12)$$

The odds ratio can be interpreted as the estimated increase in the probability of success associated with a one-unit change in the value of the predictor variable. In general, the estimated increase in the odds ratio associated with a change of d units in the predictor variable is $\exp(d\hat{\beta}_1)$.

Example 13.2 The Pneumoconiosis Data

In Example 13.1 we fit the logistic regression model

$$\hat{y} = \frac{1}{1 + e^{+4.7965 - 0.0935x}}$$

to the pneumoconiosis data of Table 13.1. Since the linear predictor contains only one regressor variable and $\hat{\beta}_1 = 0.0935$, we can compute the odds ratio from Eq. (13.12) as

$$\hat{O}_R = e^{\hat{\beta}_1} = e^{0.0935} = 1.10$$

This implies that every additional year of exposure increases the odds of contracting a severe case of pneumoconiosis by 10%. If the exposure time increases by 10 years, then the odds ratio becomes $\exp(d\hat{\beta}_1) = \exp[10(0.0935)] = 2.55$. This indicates that the odds more than double with a 10-year exposure. ■

There is a close connection between the odds ratio in logistic regression and the 2×2 contingency table that is widely used in the analysis of categorical data. Consider Table 13.3 which presents a 2×2 contingency table where the categorical response variable represents the outcome (infected, not infected) for a group of patients treated with either an active drug or a placebo. The n_{ij} are the numbers of patients in each cell. The odds ratio in the 2×2 contingency table is defined as

$$\frac{\text{Proportion infected | active drug}}{\text{Proportional infected | placebo}} = \frac{n_{11}/n_{01}}{n_{10}/n_{00}} = \frac{n_{11} \cdot n_{00}}{n_{10} \cdot n_{01}}$$

Consider a logistic regression model for these data. The linear predictor is

$$\ln\left(\frac{\pi}{1-\pi}\right) = \beta_0 + \beta_1 x_1$$

When $x_1 = 0$, we have

$$\beta_0 = \ln \frac{P(y = 1 | x_1 = 0)}{P(y = 0 | x_1 = 0)}$$

Now let $x_1 = 1$:

$$\begin{aligned} \ln\left(\frac{\pi}{1-\pi}\right) &= \beta_0 + \beta_1 x_1 \\ \ln \frac{P(y = 1 | x_1 = 1)}{P(y = 0 | x_1 = 1)} &= \ln \frac{P(y = 1 | x_1 = 0)}{P(y = 0 | x_1 = 0)} + \beta_1 \end{aligned}$$

Solving for β_1 yields

$$\beta_1 = \ln \frac{P(y = 1 | x_1 = 1) \cdot P(y = 0 | x_1 = 0)}{P(y = 0 | x_1 = 1) \cdot P(y = 1 | x_1 = 0)} = \ln \frac{n_{11} \cdot n_{00}}{n_{01} \cdot n_{10}}$$

TABLE 13.3 A 2×2 Contingency Table

Response	$x_1 = 0$, Active Drug	$x_1 = 1$, Placebo
$y = 0$, not infected	n_{00}	n_{01}
$y = 1$, infected	n_{10}	n_{11}

so $\exp(\beta_1)$ is equivalent to the odds ratio in the 2×2 contingency table. However, the odds ratio from logistic regression is much more general than the traditional 2×2 contingency table odds ratio. Logistic regression can incorporate other predictor variables, and the presence of these variables can impact the odds ratio. For example, suppose that another variable, $x_2 = \text{age}$, is available for each patient in the drug study depicted in Table 13.3. Now the linear predictor for the logistic regression model for the data would be

$$\ln\left(\frac{\pi}{1-\pi}\right) = \beta_0 + \beta_1 x_1 + \beta_2 x_2$$

This model allows the predictor variable age to impact the estimate of the odds ratio for the drug variable. The drug odds ratio is still $\exp(\beta_1)$, but the estimate of β_1 is potentially affected by the inclusion of $x_2 = \text{age}$ in the model. It would also be possible to include an interaction term between drug and age in the model, say

$$\ln\left(\frac{\pi}{1-\pi}\right) = \beta_0 + \beta_1 x_1 + \beta_2 x_2 + \beta_{12} x_1 x_2$$

In this model the odds ratio for drug depends on the level of age and would be computed as $\exp(\beta_1 + \beta_{12} x_2)$.

The interpretation of the regression coefficients in the multiple logistic regression model is similar to that for the case where the linear predictor contains only one regressor. That is, the quantity $\exp(\hat{\beta})$ is the odds ratio for regressor x_j , assuming that all other predictor variables are constant.

13.2.4 Statistical Inference on Model Parameters

Statistical inference in logistic regression is based on certain properties of maximum-likelihood estimators and on likelihood ratio tests. These are large-sample or **asymptotic** results. This section discusses and illustrates these procedures using the logistic regression model fit to the pneumoconiosis data from Example 13.1.

Likelihood Ratio Tests A likelihood ratio test can be used to compare a “full” model with a “reduced” model that is of interest. This is analogous to the “extra-sum-of-squares” technique that we have used previously to compare full and reduced models. The likelihood ratio test procedure compares twice the logarithm of the value of the likelihood function for the full model (FM) to twice the logarithm of the value of the likelihood function of the reduced model (RM) to obtain a test statistic, say

$$LR = 2 \ln \frac{L(FM)}{L(RM)} = 2[\ln L(FM) - \ln L(RM)] \quad (13.13)$$

For large samples, when the reduced model is correct, the test statistic LR follows a chi-square distribution with degrees of freedom equal to the difference in the

number of parameters between the full and reduced models. Therefore, if the test statistic LR exceeds the upper α percentage point of this chi-square distribution, we would reject the claim that the reduced model is appropriate.

The likelihood ratio approach can be used to provide a test for significance of regression in logistic regression. This test uses the current model that had been fit to the data as the full model and compares it to a reduced model that has constant probability of success. This constant-probability-of-success model is

$$E(y) = \pi = \frac{e^{\beta_0}}{1 + e^{\beta_0}}$$

that is, a logistic regression model with no regressor variables. The maximum-likelihood estimate of the constant probability of success is just y/n , where y is the total number of successes that have been observed and n is the number of observations. Substituting this into the log-likelihood function in Equation (13.9) gives the maximum value of the log-likelihood function for the reduced model as

$$\ln L(RM) = y \ln(y) + (n - y) \ln(n - y) - n \ln(n)$$

Therefore the likelihood ratio test statistic for testing significance of regression is

$$LR = 2 \left\{ \sum_{i=1}^n y_i \ln \hat{\pi}_i + \sum_{i=1}^n (n_i - y_i) \ln(1 - \hat{\pi}_i) - [y \ln(y) + (n - y) \ln(n - y) - n \ln(n)] \right\} \quad (13.14)$$

A large value of this test statistic would indicate that at least one of the regressor variables in the logistic regression model is important because it has a nonzero regression coefficient.

Minitab computes the likelihood ratio test for significance of regression in logistic regression. In the Minitab output in Table 13.2 the test statistic in Eq. (13.14) is reported as $G = 50.852$ with one degree of freedom (because the full model has only one predictor). The reported P value is 0.000 (the default reported by Minitab when the calculated P value is less than 0.001).

Testing Goodness of Fit The goodness of fit of the logistic regression model can also be assessed using a likelihood ratio test procedure. This test compares the current model to a **saturated model**, where each observation (or group of observations when $n_i > 1$) is allowed to have its own parameter (that is, a success probability). These parameters or success probabilities are y_i/n_i , where y_i is the number of successes and n_i is the number of observations. The **deviance** is defined as twice the difference in log-likelihoods between this saturated model and the full model (which is the current model) that has been fit to the data with estimated success probability $\hat{\pi}_i = \exp(\mathbf{x}'_i \hat{\boldsymbol{\beta}}) / [1 + \exp(\mathbf{x}'_i \hat{\boldsymbol{\beta}})]$. The deviance is defined as

$$D = 2 \ln \frac{L(\text{saturated model})}{L(FM)} = 2 \sum_{i=1}^n \left[y_i \ln \left(\frac{y_i}{n_i \hat{\pi}_i} \right) + (n_i - y_i) \ln \left(\frac{n_i - y_i}{n_i (1 - \hat{\pi}_i)} \right) \right] \quad (13.15)$$

In calculating the deviance, note that $y \ln(y/n\hat{\pi}) = 0$ if $y = 0$, and if $y = n$ we have $(n - y) \ln[(n - y)/n(1 - \hat{\pi})] = 0$. When the logistic regression model is an adequate fit to the data and the sample size is large, the deviance has a chi-square distribution with $n - p$ degrees of freedom, where p is the number of parameters in the model. Small values of the deviance (or a large P value) imply that the model provides a satisfactory fit to the data, while large values of the deviance imply that the current model is not adequate. A good rule of thumb is to divide the deviance by its number of degrees of freedom. If the ratio $D/(n - p)$ is much greater than unity, the current model is not an adequate fit to the data.

Minitab calculates the deviance goodness-of-fit statistic. In the Minitab output in Table 13.2, the deviance is reported under Goodness-of-Fit Tests. The value reported is $D = 6.05077$ with $n - p = 8 - 2 = 6$ degrees of freedom. The P value is 0.418 and the ratio $D/(n - p)$ is approximately unity, so there is no apparent reason to doubt the adequacy of the fit.

The deviance has an analog in ordinary normal-theory linear regression. In the linear regression model $D = SS_{\text{Res}}/\sigma^2$. This quantity has a chi-square distribution with $n - p$ degrees of freedom if the observations are normally and independently distributed. However, the deviance in normal-theory linear regression contains the unknown nuisance parameter σ^2 , so we cannot compute it directly. However, despite this small difference, the deviance and the residual sum of squares are essentially equivalent.

Goodness of fit can also be assessed with a **Pearson chi-square** statistic that compares the observed and expected probabilities of success and failure at each group of observations. The expected number of successes is $n_i \hat{\pi}_i$ and the expected number of failures is $n_i (1 - \hat{\pi}_i)$, $i = 1, 2, \dots, n$. The Pearson chi-square statistic is

$$\chi^2 = \sum_{i=1}^n \left\{ \frac{(y_i - n_i \hat{\pi}_i)^2}{n_i \hat{\pi}_i} + \frac{[(n_i - y_i) - n_i (1 - \hat{\pi}_i)]^2}{n_i (1 - \hat{\pi}_i)} \right\} = \sum_{i=1}^n \frac{(y_i - n_i \hat{\pi}_i)^2}{n_i \hat{\pi}_i (1 - \hat{\pi}_i)} \quad (13.16)$$

The Pearson chi-square goodness-of-fit statistic can be compared to a chi-square distribution with $n - p$ degrees of freedom. Small values of the statistic (or a large P value) imply that the model provides a satisfactory fit to the data. The Pearson chi-square statistic can also be divided by the number of degrees of freedom $n - p$ and the ratio compared to unity. If the ratio greatly exceeds unity, the goodness of fit of the model is questionable.

The Minitab output in Table 13.2 reports the Pearson chi-square statistic under Goodness-of-Fit Tests. The value reported is $\chi^2 = 6.02854$ with $n - p = 8 - 2 = 6$ degrees of freedom. The P value is 0.540 and the ratio $D/(n - p)$ does not exceed unity, so there is no apparent reason to doubt the adequacy of the fit.

When there are no replicates on the regressor variables, the observations can be grouped to perform a goodness-of-fit test called the Hosmer-Lemeshow test. In this procedure the observations are classified into g groups based on the estimated prob-

abilities of success. Generally, about 10 groups are used (when $g = 10$ the groups are called the deciles of risk) and the observed number of successes O_j and failures $N_j - O_j$ are compared with the expected frequencies in each group, $N_j\bar{\pi}_j$ and $N_j(1 - \bar{\pi}_j)$, where N_j is the number of observations in the j th group and the average estimated success probability in the j th group is $\bar{\pi}_j = \sum_{i \in \text{group } j} \hat{\pi}_i / N_j$. The Hosmer–Lemeshow statistic is really just a Pearson chi-square goodness-of-fit statistic comparing observed and expected frequencies:

$$HL = \sum_{j=1}^n \frac{(O_j - N_j\bar{\pi}_j)^2}{N_j\bar{\pi}_j(1 - \bar{\pi}_j)} \quad (13.17)$$

If the fitted logistic regression model is correct, the HL statistic follows a chi-square distribution with $g - 2$ degrees of freedom when the sample size is large. Large values of the HL statistic imply that the model is not an adequate fit to the data. It is also useful to compute the ratio of the Hosmer–Lemeshow statistic to the number of degrees of freedom $g - p$ with values close to unity implying an adequate fit.

MINITAB computes the Hosmer–Lemeshow statistic. For the pneumoconiosis data the HL statistic is reported in Table 13.2 under Goodness-of-Fit Tests. This computer package has combined the data into $g = 7$ groups. The grouping and calculation of observed and expected frequencies for success and failure are reported at the bottom of the MINITAB output. The value of the test statistic is $HL = 5.00360$ with $g - p = 7 - 2 = 5$ degrees of freedom. The P value is 0.415 and the ratio HL/df is very close to unity, so there is no apparent reason to doubt the adequacy of the fit.

Testing Hypotheses on Subsets of Parameters Using Deviance We can also use the deviance to test hypotheses on subsets of the model parameters, just as we used the difference in regression (or error) sums of squares to test similar hypotheses in the normal-error linear regression model case. Recall that the model can be written as

$$\eta = \mathbf{X}\boldsymbol{\beta} = \mathbf{X}_1\boldsymbol{\beta}_1 + \mathbf{X}_2\boldsymbol{\beta}_2 \quad (13.18)$$

where the **full model** has p parameters, $\boldsymbol{\beta}_1$ contains $p - r$ of these parameters, $\boldsymbol{\beta}_2$ contains r of these parameters, and the columns of the matrices \mathbf{X}_1 and \mathbf{X}_2 contain the variables associated with these parameters.

The deviance of the full model will be denoted by $D(\boldsymbol{\beta})$. Suppose that we wish to test the hypotheses

$$H_0 : \boldsymbol{\beta}_2 = \mathbf{0}, \quad H_1 : \boldsymbol{\beta}_2 \neq \mathbf{0} \quad (13.19)$$

Therefore, the **reduced model** is

$$\eta = \mathbf{X}_1\boldsymbol{\beta}_1 \quad (13.20)$$

Now fit the reduced model, and let $D(\beta_1)$ be the deviance for the reduced model. The deviance for the reduced model will always be larger than the deviance for the full model, because the reduced model contains fewer parameters. However, if the deviance for the reduced model is not much larger than the deviance for the full model, it indicates that the reduced model is about as good a fit as the full model, so it is likely that the parameters in β_2 are equal to zero. That is, we cannot reject the null hypothesis above. However, if the difference in deviance is large, at least one of the parameters in β_2 is likely not zero, and we should reject the null hypothesis. Formally, the difference in deviance is

$$D(\beta_2 | \beta_1) = D(\beta_1) - D(\beta) \quad (13.21)$$

and this quantity has $n - (p - r) - (n - p) = r$ degrees of freedom. If the null hypothesis is true and if n is large, the difference in deviance in Eq. (13.21) has a chi-square distribution with r degrees of freedom. Therefore, the test statistic and decision criteria are

$$\begin{aligned} \text{if } D(\beta_2 | \beta_1) &\geq \chi_{\alpha, r}^2 && \text{reject the null hypothesis} \\ \text{if } D(\beta_2 | \beta_1) &< \chi_{\alpha, r}^2 && \text{do not reject the null hypothesis} \end{aligned} \quad (13.22)$$

Sometimes the difference in deviance $D(\beta_2 | \beta_1)$ is called the **partial deviance**.

Example 13.3 The Pneumoconiosis Data

Once again, reconsider the pneumoconiosis data of Table 13.1. The model we initially fit to the data is

$$\hat{y} = \hat{\pi} = \frac{1}{1 + e^{+4.7965 - 0.0935x}}$$

Suppose that we wish to determine whether adding a quadratic term in the linear predictor would improve the model. Therefore, we will consider the full model to be

$$y = \frac{1}{1 + e^{-(\beta_0 + \beta_1x + \beta_{11}x^2)}}$$

Table 13.4 contains the output from Minitab for this model. Now the linear predictor for the full model can be written as

$$\begin{aligned} \eta &= \mathbf{X}\beta \\ &= \mathbf{X}_1\beta_1 + \mathbf{X}_2\beta_2 \\ &= \beta_0 + \beta_1x + \beta_{11}x^2 \end{aligned}$$

TABLE 13.4 Binary Logistic Regression: Severe Cases, Number of Miners versus Years

Link Function Logit		Value		Count					
Response Information		Success		44					
Severe cases		Failure		327					
Number of miners		Total		371					
Logistic Regression Table									
Predictor	Coef	SE Coef	Z	P	Odds Ratio	95% Lower	95% Upper	CI	Upper
Constant	-6.71079	1.53523	-4.37	0.000					
Years	0.227607	0.0927560	2.45	0.014	1.26	1.05	1.51		
Years*Years	-0.0020789	0.0013612	-1.53	0.127	1.00	1.00	1.00		
Log-Likelihood=-108.279									
Test that all slopes are zero: G = 53.621, DF = 2, P-value = 0.000									
Goodness-of-Fit Tests									
Method	Chi-Square	DF	P						
Pearson	2.94482	5	0.708						
Deviance	3.28164	5	0.657						
Hosmer-Lemeshow	2.80267	5	0.730						
Table of Observed and Expected Frequencies: (See Hosmer-Lemeshow Test for the Pearson Chi-Square Statistic)									
Value	1	2	3	4	5	6	7	Total	
Success									
Obs	0	1	3	8	9	8	15	44	
Exp	0.4	1.2	2.5	5.6	9.9	10.5	13.8		
Failure									
Obs	98	53	40	40	42	30	24	327	
Exp	97.6	52.8	40.5	42.4	41.1	27.5	25.2		
Total	98	54	43	48	51	38	39	371	

From Table 13.4, we find that the deviance for the full model is

$$D(\boldsymbol{\beta}) = 3.28164$$

with $n - p = 8 - 3 = 5$ degrees of freedom. Now the reduced model has $\mathbf{X}_1\boldsymbol{\beta}_1 = \beta_0 + \beta_1x$, so $\mathbf{X}_2\boldsymbol{\beta}_2 = \beta_{11}x^2$ with $r = 1$ degree of freedom. The reduced model was originally fit in Example 13.1, and Table 13.2 shows the deviance for the reduced model to be

$$D(\boldsymbol{\beta}_1) = 6.05077$$

with $p - r = 3 - 1 = 2$ degrees of freedom. Therefore, the difference in deviance between the full and reduced models is computed using Eq. (13.21) as

$$\begin{aligned} D(\boldsymbol{\beta}_2 | \boldsymbol{\beta}_1) &= D(\boldsymbol{\beta}_1) - D(\boldsymbol{\beta}) \\ &= 6.05077 - 3.28164 \\ &= 2.76913 \end{aligned}$$

which would be referred to a chi-square distribution with $r = 1$ degree of freedom. Since the P value associated with the difference in deviance is 0.0961, we might conclude that there is some marginal value in including the quadratic term in the regressor variable $x = \text{years of exposure}$ in the linear predictor for the logistic regression model. ■

Tests on Individual Model Coefficients Tests on individual model coefficients, such as

$$H_0 : \beta_j = 0, \quad H_1 : \beta_j \neq 0 \quad (13.22)$$

can be conducted by using the difference-in-deviance method as illustrated in Example 13.3. There is another approach, also based on the theory of maximum likelihood estimators. For large samples, the distribution of a maximum-likelihood estimator is approximately normal with little or no bias. Furthermore, the variances and covariances of a set of maximum-likelihood estimators can be found from the second partial derivatives of the log-likelihood function with respect to the model parameters, evaluated at the maximum-likelihood estimates. Then a t -like statistic can be constructed to test the above hypotheses. This is sometimes referred to as **Wald inference**.

Let \mathbf{G} denote the $p \times p$ matrix of second partial derivatives of the log-likelihood function, that is,

$$G_{ij} = \frac{\partial^2 \mathcal{L}(\boldsymbol{\beta})}{\partial \beta_i \partial \beta_j}, \quad i, j = 0, 1, \dots, k$$

\mathbf{G} is called the **Hessian matrix**. If the elements of the Hessian are evaluated at the maximum-likelihood estimators $\boldsymbol{\beta} = \hat{\boldsymbol{\beta}}$, the large-sample approximate covariance matrix of the regression coefficients is

$$\text{Var}(\hat{\boldsymbol{\beta}}) = -\mathbf{G}(\hat{\boldsymbol{\beta}})^{-1} = (\mathbf{X}'\mathbf{V}\mathbf{X})^{-1} \quad (13.23)$$

Notice that this is just the covariance matrix of $\hat{\boldsymbol{\beta}}$ given earlier. The square roots of the diagonal elements of this covariance matrix are the large-sample standard errors of the regression coefficients, so the test statistic for the null hypothesis is

$$H_0 : \beta_j = 0, \quad H_1 : \beta_j \neq 0$$

is

$$Z_0 = \frac{\hat{\beta}_j}{\text{se}(\hat{\beta}_j)} \quad (13.24)$$

The reference distribution for this statistic is the standard normal distribution. Some computer packages square the Z_0 statistic and compare it to a chi-square distribution with one degree of freedom.

Example 13.4 The Pneumoconiosis Data

Table 13.3 contains output from MINITAB for the pneumoconiosis data, originally given in Table 13.1. The fitted model is

$$\hat{y} = \frac{1}{1 + e^{+6.7108 - 0.2276x + 0.0021x^2}}$$

The Minitab output gives the standard errors of each model coefficient and the Z_0 test statistic in Eq. (13.24). Notice that the P value for β_1 is $P = 0.014$, implying that years of exposure is an important regressor. However, notice that the P value for β_2 is $P = 0.127$, suggesting that the squared term in years of exposure does not contribute significantly to the fit.

Recall from the previous example that when we tested for the significance of β_{11} using the partial deviance method we obtained a different P value. Now in linear regression, the t test on a single regressor is equivalent to the partial F test on a single variable (recall that the square of the t statistic is equal to the partial F statistic). However, this equivalence is only true for **linear models**, and the GLM is a **nonlinear model**. ■

Confidence Intervals It is straightforward to use Wald inference to construct confidence intervals in logistic regression. Consider first finding confidence intervals on individual regression coefficients in the linear predictor. An approximate $100(1 - \alpha)$ percent confidence interval on the j th model coefficient is

$$\hat{\beta}_j - Z_{\alpha/2}\text{se}(\hat{\beta}_j) \leq \beta_j \leq \hat{\beta}_j + Z_{\alpha/2}\text{se}(\hat{\beta}_j) \quad (13.25)$$

Example 13.5 The Pneumoconiosis Data

Using the Minitab output in Table 13.3, we can find an approximate 95% confidence interval on β_{11} from Eq. (13.25) as follows:

$$\begin{aligned}\hat{\beta}_{11} - Z_{0.025}\text{se}(\hat{\beta}_{11}) &\leq \beta_{11} \leq \hat{\beta}_{11} + Z_{0.025}\text{se}(\hat{\beta}_{11}) \\ -0.0021 - 1.96(0.00136) &\leq \beta_{11} \leq -0.0021 + 1.96(0.00136) \\ -0.0048 &\leq \beta_{11} \leq 0.0006\end{aligned}$$

Notice that the confidence interval includes zero, so at the 5% significance level, we would not reject the hypothesis that this model coefficient is zero. The regression coefficient β_j is also the logarithm of the odds ratio. Because we know how to find a confidence interval (CI) for β_j , it is easy to find a CI for the odds ratio. The point estimate of the odds ratio is $\hat{O}_R = \exp(\hat{\beta}_j)$ and the $100(1 - \alpha)$ percent CI for the odds ratio is

$$\exp[\hat{\beta}_j - Z_{\alpha/2}\text{se}(\hat{\beta}_j)] \leq O_R \leq \exp[\hat{\beta}_j + Z_{\alpha/2}\text{se}(\hat{\beta}_j)] \quad (13.26)$$

The CI for the odds ratio is generally not symmetric around the point estimate. Furthermore, the point estimate $\hat{O}_R = \exp(\hat{\beta}_j)$ actually estimates the median of the sampling distribution of \hat{O}_R .

Example 13.6 The Pneumoconiosis Data

Reconsider the original logistic regression model that we fit to the pneumoconiosis data in Example 13.1. From the Minitab output for this data shown in Table 13.2 we find that the estimate of β_1 is $\hat{\beta}_1 = 0.0934629$ and the odds ratio $\hat{O}_R = \exp(\hat{\beta}_1) = 1.10$. Because the standard error of $\hat{\beta}_1$ is $\text{se}(\hat{\beta}_1) = 0.0154258$, we can find a 95% CI on the odds ratio as follows:

$$\begin{aligned}\exp[0.0934629 - 1.96(0.0154258)] &\leq O_R \leq \exp[0.0934629 + 1.96(0.0154258)] \\ \exp(0.063228) &\leq O_R \leq \exp(0.123697) \\ 1.07 &\leq O_R \leq 1.13\end{aligned}$$

This agrees with the 95% CI reported by Minitab in Table 13.2. ■

It is possible to find a CI on the linear predictor at any set of values of the predictor variables that is of interest. Let $\mathbf{x}'_0 = [1, x_{01}, x_{02}, \dots, x_{0k}]$ be the values of the regressor variables that are of interest. The linear predictor evaluated at \mathbf{x}_0 is $\mathbf{x}'_0\hat{\boldsymbol{\beta}}$. The variance of the linear predictor at this point is

$$\text{Var}(\mathbf{x}'_0\hat{\boldsymbol{\beta}}) = \mathbf{x}'_0 \text{Var}(\hat{\boldsymbol{\beta}}) \mathbf{x}_0 = \mathbf{x}'_0 (\mathbf{X}'\mathbf{V}\mathbf{X})^{-1} \mathbf{x}_0$$

so the $100(1 - \alpha)$ percent CI on the linear predictor is

$$\mathbf{x}'_0 \hat{\boldsymbol{\beta}} - Z_{\alpha/2} \sqrt{\mathbf{x}'_0 (\mathbf{X}'\mathbf{V}\mathbf{X})^{-1} \mathbf{x}_0} \leq \mathbf{x}'_0 \boldsymbol{\beta} \leq \mathbf{x}'_0 \hat{\boldsymbol{\beta}} + Z_{\alpha/2} \sqrt{\mathbf{x}'_0 (\mathbf{X}'\mathbf{V}\mathbf{X})^{-1} \mathbf{x}_0} \quad (13.27)$$

The CI on the linear predictor given in Eq. (13.27) enables us to find a CI on the estimated probability of success π_0 at the point of interest $\mathbf{x}'_0 = [1, x_{01}, x_{02}, \dots, x_{0k}]$. Let

$$L(\mathbf{x}_0) = \mathbf{x}'_0 \hat{\boldsymbol{\beta}} - Z_{\alpha/2} \sqrt{\mathbf{x}'_0 (\mathbf{X}'\mathbf{V}\mathbf{X})^{-1} \mathbf{x}_0}$$

and

$$U(\mathbf{x}_0) = \mathbf{x}'_0 \hat{\boldsymbol{\beta}} + Z_{\alpha/2} \sqrt{\mathbf{x}'_0 (\mathbf{X}'\mathbf{V}\mathbf{X})^{-1} \mathbf{x}_0}$$

be the lower and upper $100(1 - \alpha)$ percent confidence bounds on the linear predictor at the point \mathbf{x}_0 from Eq. (13.27). Then the point estimate of the probability of success at this point is $\hat{\pi}_0 = \exp(\mathbf{x}'_0 \hat{\boldsymbol{\beta}}) / [1 + \exp(\mathbf{x}'_0 \hat{\boldsymbol{\beta}})]$ and the $100(1 - \alpha)$ percent CI on the probability of success at \mathbf{x}_0 is

$$\frac{\exp[L(\mathbf{x}_0)]}{1 + \exp[L(\mathbf{x}_0)]} \leq \pi_0 \leq \frac{\exp[U(\mathbf{x}_0)]}{1 + \exp[U(\mathbf{x}_0)]} \quad (13.28)$$

Example 13.7 The Pneumoconiosis Data

Suppose that we want to find a 95% CI on the probability of miners with $x = 40$ years of exposure contracting pneumoconiosis. From the fitted logistic regression model in Example 13.1, we can calculate a point estimate of the probability at 40 years of exposure as

$$\hat{\pi}_0 = \frac{e^{-4.7965 + 0.0935(40)}}{1 + e^{-4.7965 + 0.0935(40)}} = \frac{e^{-1.0565}}{1 + e^{-1.0565}} = 0.2580$$

To find the CI, we need to calculate the variance of the linear predictor at this point. The variance is

$$\begin{aligned} \text{Var}(\mathbf{x}'_0 \hat{\boldsymbol{\beta}}) &= \mathbf{x}'_0 (\mathbf{X}'\mathbf{V}\mathbf{X})^{-1} \mathbf{x}_0 \\ &= [1 \quad 40] \begin{bmatrix} 0.32383 & -0.0083480 \\ -0.0083480 & 0.0002380 \end{bmatrix} \begin{bmatrix} 1 \\ 40 \end{bmatrix} = 0.036243 \end{aligned}$$

Now

$$L(\mathbf{x}_0) = -1.0565 - 1.96\sqrt{0.036343} = -1.4296$$

and

$$U(\mathbf{x}_0) = -1.0565 + 1.96\sqrt{0.036343} = -0.6834$$

Therefore the 95% CI on the estimated probability of contracting pneumoconiosis for miners that have 40 years of exposure is

$$\begin{aligned}\frac{\exp[L(\mathbf{x}_0)]}{1 + \exp[L(\mathbf{x}_0)]} &\leq \pi_0 \leq \frac{\exp[U(\mathbf{x}_0)]}{1 + \exp[U(\mathbf{x}_0)]} \\ \frac{\exp(-1.4296)}{1 + \exp(-1.4296)} &\leq \pi_0 \leq \frac{\exp(-0.6834)}{1 + \exp(-0.6834)} \\ 0.1932 &\leq \pi_0 \leq 0.3355\end{aligned}$$

■

13.2.5 Diagnostic Checking in Logistic Regression

Residuals can be used for diagnostic checking and investigating model adequacy in logistic regression. The ordinary residuals are defined as usual,

$$e_i = y_i - \hat{y}_i = y_i - n_i \hat{\pi}_i, \quad i = 1, 2, \dots, n \quad (13.29)$$

In linear regression the ordinary residuals are components of the residual sum of squares; that is, if the residuals are squared and summed, the residual sum of squares results. In logistic regression, the quantity analogous to the residual sum of squares is the deviance. This leads to a **deviance residual**, defined as

$$d_i = \pm \left\{ 2 \left[y_i \ln \left(\frac{y_i}{n_i \hat{\pi}_i} \right) + (n_i - y_i) \ln \left(\frac{n_i - y_i}{n_i (1 - \hat{\pi}_i)} \right) \right] \right\}^{1/2}, \quad i = 1, 2, \dots, n \quad (13.30)$$

The sign of the deviance residual is the same as the sign of the corresponding ordinary residual. Also, when $y_i = 0$, $d_i = -\sqrt{-2n \ln(1 - \hat{\pi}_i)}$, and when $y_i = n_i$, $d_i = \sqrt{-2n \ln \hat{\pi}_i}$. Similarly, we can define a **Pearson residual**

$$r_i = \frac{y_i - n_i \hat{\pi}_i}{\sqrt{n_i \hat{\pi}_i (1 - \hat{\pi}_i)}}, \quad i = 1, 2, \dots, n \quad (13.31)$$

It is also possible to define a hat matrix analog for logistic regression,

$$\mathbf{H} = \mathbf{V}^{1/2} \mathbf{X} (\mathbf{X}' \mathbf{V} \mathbf{X})^{-1} \mathbf{X}' \mathbf{V}^{1/2} \quad (13.32)$$

where \mathbf{V} is the diagonal matrix defined earlier that has the variances of each observation on the main diagonal, $V_{ii} = n_i \hat{\pi}_i (1 - \hat{\pi}_i)$, and these variances are calculated using the estimated probabilities that result from the fitted logistic regression model. The diagonal elements of \mathbf{H} , h_{ii} , can be used to calculate a **standardized Pearson residual**

$$sr_i = \frac{r_i}{\sqrt{1 - h_{ii}}} = \frac{y_i - n_i \hat{\pi}_i}{\sqrt{(1 - h_{ii}) n_i \hat{\pi}_i (1 - \hat{\pi}_i)}}, \quad i = 1, 2, \dots, n \quad (13.33)$$

The deviance and Pearson residuals are the most appropriate for conducting model adequacy checks. Plots of these residuals versus the estimated probability and a

TABLE 13.5 Residuals for the Pneumoconiosis Data

Observation	Observed Probability	Estimated Probability	Deviance Residuals	Pearson Residuals	h_{ii}	Standardized Pearson Residuals
1	0.000000	0.014003	-1.66251	-1.17973	0.317226	-1.42772
2	0.018519	0.032467	-0.62795	-0.57831	0.214379	-0.65246
3	0.069767	0.058029	0.31961	0.32923	0.174668	0.36239
4	0.166667	0.097418	1.48516	1.61797	0.186103	1.79344
5	0.176471	0.159029	0.33579	0.34060	0.211509	0.38358
6	0.210526	0.248861	-0.55678	-0.54657	0.249028	-0.63072
7	0.357143	0.378202	-0.23067	-0.22979	0.387026	-0.29350
8	0.454545	0.504215	-0.32966	-0.32948	0.260001	-0.38301

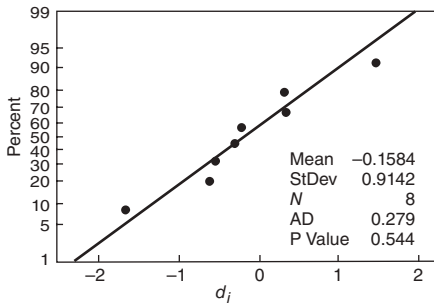

Figure 13.4 Normal probability plot of the deviance residuals.

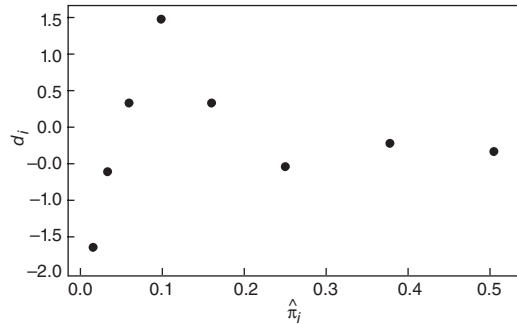

Figure 13.5 Plot of deviance residuals versus estimated probabilities.

normal probability plot of the deviance residuals are useful in checking the fit of the model at individual data points and in checking for possible outliers.

Table 13.5 displays the deviance residuals, Pearson residuals, hat matrix diagonals, and the standardized Pearson residuals for the pneumoconiosis data. To illustrate the calculations, consider the deviance residual for the third observation. From Eq. (13.30)

$$\begin{aligned}
 d_3 &= \left\{ 2 \left[y_3 \ln \left(\frac{y_3}{n_3 \hat{\pi}_3} \right) + (n_3 - y_3) \ln \left(\frac{n_3 - y_3}{n_3 (1 - \hat{\pi}_3)} \right) \right] \right\}^{1/2} \\
 &= + \left\{ 2 \left[3 \ln \left(\frac{3}{43(0.058029)} \right) + (43 - 3) \ln \left(\frac{43 - 3}{43(1 - 0.058029)} \right) \right] \right\}^{1/2} \\
 &= 0.3196
 \end{aligned}$$

which closely matches the value reported by Minitab in Table 13.5. The sign of the deviance residual d_3 is positive because the ordinary residual $e_3 = y_3 - n_3 \hat{\pi}_3$ is positive.

Figure 13.4 is the normal probability plot of the deviance residuals and Figure 13.5 plots the deviance residuals versus the estimated probability of success. Both

plots indicate that there may be some problems with the model fit. The plot of deviance residuals versus the estimated probability indicates that the problems may be at low estimated probabilities. However, the number of distinct observations is small ($n = 8$), so we should not attempt to read too much into these plots.

13.2.6 Other Models for Binary Response Data

In our discussion of logistic regression we have focused on using the logit, defined as $\ln[\pi/(1 - \pi)]$, to force the estimated probabilities to lie between zero and unity. This leads to the logistic regression model

$$\pi = \frac{\exp(\mathbf{x}'\boldsymbol{\beta})}{1 + \exp(\mathbf{x}'\boldsymbol{\beta})}$$

However, this is not the only way to model a binary response. Another possibility is to make use of the cumulative normal distribution, say $\Phi^{-1}(\pi)$. The function $\Phi^{-1}(\pi)$ is called the **Probit**. A linear predictor can be related to the probit, $\mathbf{x}'\boldsymbol{\beta} = \Phi^{-1}(\pi)$, resulting in a regression model

$$\pi = \Phi(\mathbf{x}'\boldsymbol{\beta}) \tag{13.34}$$

Another possible model is provided by the **complimentary log-log** relationship $\log[-\log(1 - \pi) = \mathbf{x}'\boldsymbol{\beta}]$. This leads to the regression model

$$\pi = 1 - \exp[-\exp(\mathbf{x}'\boldsymbol{\beta})] \tag{13.35}$$

A comparison of all three possible models for the linear predictor $\mathbf{x}'\boldsymbol{\beta} = 1 + 5x$ is shown in Figure 13.6. The logit and probit functions are very similar, except when the estimated probabilities are very close to either 0 or 1. Both of these functions have estimated probability $\pi = \frac{1}{2}$ when $x = -\beta_0/\beta_1$ and exhibit symmetric behavior around this value. The complimentary log-log function is not symmetric. In general, it is very difficult to see meaningful differences between these three models when sample sizes are small.

13.2.7 More Than Two Categorical Outcomes

Logistic regression considers the situation where the response variable is categorical, with only two outcomes. We can extend the classical logistic regression model to cases involving more than two categorical outcomes. First consider a case where there are $m + 1$ possible categorical outcomes but the outcomes are **nominal**. By this we mean that there is no natural ordering of the response categories. Let the outcomes be represented by $0, 1, 2, \dots, m$. The probabilities that the responses on observation i take on one of the $m + 1$ possible outcomes can be modeled as

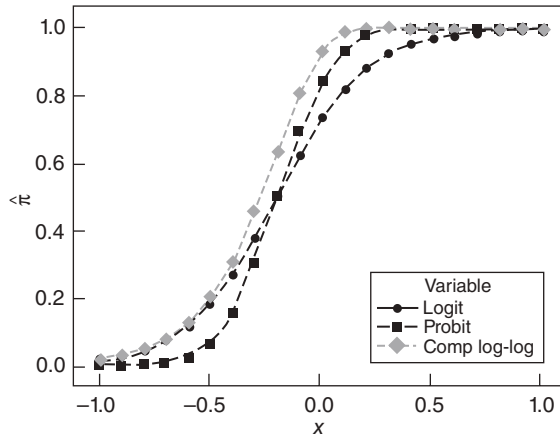

Figure 13.6 Logit, probit, and complimentary log-log functions for the linear predictor $\mathbf{x}'\boldsymbol{\beta} = 1 + 5x$.

$$\begin{aligned}
 P(y_i = 0) &= \frac{1}{1 + \sum_{j=1}^m \exp[\mathbf{x}'_i \boldsymbol{\beta}^{(j)}]} \\
 P(y_i = 1) &= \frac{\exp[\mathbf{x}'_i \boldsymbol{\beta}^{(1)}]}{1 + \sum_{j=1}^m \exp[\mathbf{x}'_i \boldsymbol{\beta}^{(j)}]} \\
 P(y_i = m) &= \frac{\exp[\mathbf{x}'_i \boldsymbol{\beta}^{(m)}]}{1 + \sum_{j=1}^m \exp[\mathbf{x}'_i \boldsymbol{\beta}^{(j)}]}
 \end{aligned} \tag{13.36}$$

Notice that there are m parameter vectors. Comparing each response category to a “baseline” category produces logits

$$\begin{aligned}
 \ln \frac{P(y_i = 1)}{P(y_i = 0)} &= \mathbf{x}'_i \boldsymbol{\beta}^{(1)} \\
 \ln \frac{P(y_i = 2)}{P(y_i = 0)} &= \mathbf{x}'_i \boldsymbol{\beta}^{(2)} \\
 \ln \frac{P(y_i = m)}{P(y_i = 0)} &= \mathbf{x}'_i \boldsymbol{\beta}^{(m)}
 \end{aligned} \tag{13.37}$$

where our choice of zero as the baseline category is arbitrary. Maximum-likelihood estimation of the parameters in these models is fairly straightforward and can be performed by several software packages.

A second case involving multilevel categorical response is an **ordinal** response. For example, customer satisfaction may be measured on a scale as not satisfied, indifferent, somewhat satisfied, and very satisfied. These outcomes would be coded as 0, 1, 2, and 3, respectively. The usual approach for modeling this type of response data is to use logits of cumulative probabilities:

$$\ln \frac{P(y_i \leq k)}{1 - P(y_i \leq k)} = \alpha_k + \mathbf{x}'_i \boldsymbol{\beta}, \quad k = 0, 1, \dots, m$$

The cumulative probabilities are

$$P(y_i \leq k) = \frac{\exp(\alpha_k + \mathbf{x}'_i \boldsymbol{\beta})}{1 + \exp(\alpha_k + \mathbf{x}'_i \boldsymbol{\beta})}, \quad k = 0, 1, \dots, m$$

This model basically allows each response level to have its own unique intercept. The intercepts increase with the ordinal rank of the category. Several software packages can also fit this variation of the logistic regression model.

13.3 POISSON REGRESSION

We now consider another regression modeling scenario where the response variable of interest is not normally distributed. In this situation the response variable represents a count of some relatively rare event, such as defects in a unit of manufactured product, errors or “bugs” in software, or a count of particulate matter or other pollutants in the environment. The analyst is interested in modeling the relationship between the observed counts and potentially useful regressor or predictor variables. For example, an engineer could be interested in modeling the relationship between the observed number of defects in a unit of product and production conditions when the unit was actually manufactured.

We assume that the response variable y_i is a count, such that the observation $y_i = 0, 1, \dots$. A reasonable probability model for count data is often the Poisson distribution

$$f(y) = \frac{e^{-\mu} \mu^y}{y!}, \quad y = 0, 1, \dots \quad (13.38)$$

where the parameter $\mu > 0$. The Poisson is another example of a probability distribution where the mean and variance are related. In fact, for the Poisson distribution it is straightforward to show that

$$E(y) = \mu \quad \text{and} \quad \text{Var}(y) = \mu$$

That is, both the mean **and** variance of the Poisson distribution are equal to the parameter μ .

The Poisson regression model can be written as

$$y_i = E(y_i) + \varepsilon_i, \quad i = 1, 2, \dots, n \quad (13.39)$$

We assume that the expected value of the observed response can be written as

$$E(y_i) = \mu_i$$

and that there is a function g that relates the mean of the response to a linear predictor, say

$$g(\mu_i) = \eta_i = \beta_0 + \beta_1 x_1 + \dots + \beta_k x_k = \mathbf{x}'_i \boldsymbol{\beta} \quad (13.40)$$

The function g is usually called the **link function**. The relationship between the mean and the linear predictor is

$$\mu_i = g^{-1}(\eta_i) = g^{-1}(\mathbf{x}'_i \boldsymbol{\beta}) \quad (13.41)$$

There are several link functions that are commonly used with the Poisson distribution. One of these is the **identity link**

$$g(\mu_i) = \mu_i = \mathbf{x}'_i \boldsymbol{\beta} \quad (13.42)$$

When this link is used, $E(y_i) = \mu_i = \mathbf{x}'_i \boldsymbol{\beta}$ since $\mu_i = g^{-1}(\mathbf{x}'_i \boldsymbol{\beta}) = \mathbf{x}'_i \boldsymbol{\beta}$. Another popular link function for the Poisson distribution is the **log link**

$$g(\mu_i) = \ln(\mu_i) = \mathbf{x}'_i \boldsymbol{\beta} \quad (13.43)$$

For the log link in Eq. (13.43), the relationship between the mean of the response variable and the linear predictor is

$$\mu_i = g^{-1}(\mathbf{x}'_i \boldsymbol{\beta}) = e^{\mathbf{x}'_i \boldsymbol{\beta}} \quad (13.44)$$

The log link is particularly attractive for Poisson regression because it ensures that all of the predicted values of the response variable will be nonnegative.

The method of maximum likelihood is used to estimate the parameters in Poisson regression. The development follows closely the approach used for logistic regression. If we have a random sample of n observations on the response y and the predictors x , then the likelihood function is

$$\begin{aligned} L(\mathbf{y}, \boldsymbol{\beta}) &= \prod_{i=1}^n f_i(y_i) = \prod_{i=1}^n \frac{e^{-\mu_i} \mu_i^{y_i}}{y_i!} \\ &= \frac{\prod_{i=1}^n \mu_i^{y_i} \exp\left(-\sum_{i=1}^n \mu_i\right)}{\prod_{i=1}^n y_i!} \end{aligned} \quad (13.45)$$

where $\mu_i = g^{-1}(\mathbf{x}'_i \boldsymbol{\beta})$. Once the link function is selected, we maximize the log-likelihood

$$\ln L(\mathbf{y}, \boldsymbol{\beta}) = \sum_{i=1}^n y_i \ln(\mu_i) - \sum_{i=1}^n \mu_i - \sum_{i=1}^n \ln(y_i!) \quad (13.46)$$

Iteratively reweighted least squares can be used to find the maximum-likelihood estimates of the parameters in Poisson regression, following an approach similar to that used for logistic regression. Once the parameter estimates $\hat{\boldsymbol{\beta}}$ are obtained, the fitted Poisson regression model is

$$\hat{y}_i = g^{-1}(\mathbf{x}'_i \hat{\boldsymbol{\beta}}) \quad (13.47)$$

For example, if the identity link is used, the prediction equation becomes

$$\hat{y}_i = g^{-1}(\mathbf{x}'_i \hat{\boldsymbol{\beta}}) = \mathbf{x}'_i \hat{\boldsymbol{\beta}}$$

and if the log link is selected, then

$$\hat{y}_i = g^{-1}(\mathbf{x}'_i \hat{\boldsymbol{\beta}}) = \exp(\mathbf{x}'_i \hat{\boldsymbol{\beta}})$$

Inference on the model and its parameters follows exactly the same approach as used for logistic regression. That is, model deviance and the Pearson chi-square statistic are overall measures of goodness of fit, and tests on subsets of model parameters can be performed using the difference in deviance between the full and reduced models. These are likelihood ratio tests. Wald inference, based on large-sample properties of maximum-likelihood estimators, can be used to test hypotheses and construct confidence intervals on individual model parameters.

Example 13.8 The Aircraft Damage Data

During the Vietnam War, the United States Navy operated several types of attack (a **bomber** in USN parlance) aircraft, often for low-altitude strike missions against bridges, roads, and other transportation facilities. Two of these included the McDonnell Douglas A-4 Skyhawk and the Grumman A-6 Intruder. The A-4 is a single-engine, single-place light-attack aircraft used mainly in daylight. It was also flown by the Blue Angels, the Navy's flight demonstration team, for many years. The A-6 is a twin-engine, dual-place, all-weather medium-attack aircraft with excellent day/night capabilities. However, the Intruder could not be operated from the smaller Essex-class aircraft carriers, many of which were still in service during the conflict.

Considerable resources were deployed against the A-4 and A-6, including small arms, AAA or antiaircraft artillery, and surface-to-air missiles. Table 13.6 contains data from 30 strike missions involving these two types of aircraft. The regressor x_1 is an indicator variable (A-4 = 0 and A-6 = 1), and the other regressors

TABLE 13.6 Aircraft Damage Data

Observation	y	x_1	x_2	x_3
1	0	0	4	91.5
2	1	0	4	84.0
3	0	0	4	76.5
4	0	0	5	69.0
5	0	0	5	61.5
6	0	0	5	80.0
7	1	0	6	72.5
8	0	0	6	65.0
9	0	0	6	57.5
10	2	0	7	50.0
11	1	0	7	103.0
12	1	0	7	95.5
13	1	0	8	88.0
14	1	0	8	80.5
15	2	0	8	73.0
16	3	1	7	116.1
17	1	1	7	100.6
18	1	1	7	85.0
19	1	1	10	69.4
20	2	1	10	53.9
21	0	1	10	112.3
22	1	1	12	96.7
23	1	1	12	81.1
24	2	1	12	65.6
25	5	1	8	50.0
26	1	1	8	120.0
27	1	1	8	104.4
28	5	1	14	88.9
29	5	1	14	73.7
30	7	1	14	57.8

x_2 and x_3 are bomb load (in tons) and total months of aircrew experience. The response variable is the number of locations where damage was inflicted on the aircraft.

We will model the damage response as a function of the three regressors. Since the response is a count, we will use a Poisson regression model with the log link. Table 13.7 presents some of the output from SAS PROC GENMOD a widely used software package for fitting generalized linear models, which include Poisson regression. The SAS code for this example is

```
proc genmod;
model y = x1 x2 x3 / dist = poisson type1 type3;
```

The Type 1 analysis is similar to the Type 1 sum of squares analysis, also known as the sequential sum of squares analysis. The test on any given term is conditional

TABLE 13.7 SAS PROC GENMOD Output for Aircraft Damage Data in Example 13.8

The GENMOD Procedure					
Model Information					
Description	Value				
Data Set	WORK.PLANE				
Distribution	POISSON				
Link Function	LOG				
Dependent Variable	Y				
Observations Used	30				
Criteria for Assessing Goodness of Fit					
Criterion	DF	Value	Value/DF		
Deviance	26	28.4906	1.0958		
Scaled Deviance	26	28.4906	1.0958		
Pearson Chi-Square	26	25.4279	0.9780		
Scaled Pearson X2	26	25.4279	0.9780		
Log Likelihood		-11.3455			
Analysis of Parameter Estimates					
Parameter	DF	Estimate	Std Err	Chi Square	Pr > Chi
INTERCEPT	1	-0.3824	0.8630	0.1964	0.6577
X1	1	0.8805	0.5010	3.0892	0.0788
X2	1	0.1352	0.0653	4.2842	0.0385
X3	1	-0.0127	0.0080	2.5283	0.1118
SCALE	0	1.0000	0.0000		
Note: The scale parameter was held fixed.					
LR Statistics for Type 1 Analysis					
Source	Deviance	DF	Chi Square	Pr > Chi	
INTERCEPT	57.5983	0			
X1	38.3497	1	19.2486	0.0001	
X2	31.0223	1	7.3274	0.0068	
X3	28.4906	1	2.5316	0.1116	
LR Statistics for Type 3 Analysis					
Source	DF	Chi Square	Pr > Chi		
X1	1	3.1155	0.0775		
X2	1	4.3911	0.0361		
X3	1	2.5316	0.1116		
The GENMOD Procedure					
Model Information					
Description	Value				
Data Set	WORK.PLANE				
Distribution	POISSON				
Link Function	LOG				
Dependent Variable	Y				
Observations Used	30				

TABLE 13.7 (Continued)

Criteria for Assessing Goodness of Fit					
Criterion	DF	Value	Value/DF		
Deviance	28	33.0137	1.1791		
Scaled Deviance	28	33.0137	1.1791		
Pearson Chi-Square	28	33.4108	1.1932		
Scaled Pearson X2	28	33.4108	1.1932		
Log Likelihood		-13.6071			

Analysis of Parameter Estimates					
Parameter	DF	Estimate	Std Err	Chi Square	Pr > Chi
INTERCEPT	1	-1.6491	0.4996	10.8980	0.0010
X2	1	0.2282	0.0462	24.3904	0.0001
SCALE	0	1.0000	0.0000		

Note: The scale parameter was held fixed.

LR Statistics for Type 1 Analysis					
Source	Deviance	DF	Chi Square	Pr > Chi	
INTERCEPT	57.5983	0			
X2	33.0137	1	24.5846	0.0001	

LR Statistics for Type 3 Analysis					
Source	Deviance	DF	Chi Square	Pr > Chi	
X2	33.0137	1	24.5846	0.0001	

based on all previous terms in the analysis being included in the model. The intercept is always assumed in the model, which is why the Type 1 analysis begins with the term x_1 , which is the first term specified in the model statement. The Type 3 analysis is similar to the individual t -tests in that it is a test of the contribution of the specific term given all the other terms in the model. The model in the first page of the table uses all three regressors. The model adequacy checks based on deviance and the Pearson chi-square statistics are satisfactory, but we notice that $x_3 =$ crew experience is not significant, using both the Wald test and the type 3 partial deviance (notice that the Wald statistic reported is $[\hat{\beta}/se(\hat{\beta})]^2$, which is referred to a chi-square distribution with a single degree of freedom). This is a reasonable indication that x_3 can be removed from the model. When x_3 is removed, however, it turns out that now $x_1 =$ type of aircraft is no longer significant (you can easily verify that the type 3 partial deviance for x_1 in this model has a P value of 0.1582). A moment of reflection on the data in Table 13.6 will reveal that there is a lot of multicollinearity in the data. Essentially, the A-6 is a larger aircraft so it will carry a heavier bomb load, and because it has a two-man crew, it may tend to have more total months of crew experience. Therefore, as x_1 increases, there is a tendency for both of the other regressors to also increase.

To investigate the potential usefulness of various subset models, we fit all three two-variable models and all three one-variable models to the data in Table 13.6. A brief summary of the results obtained is as follows:

Model	Deviance	Difference in Deviance Compared to Full Model	P Value
$x_1x_2x_3$	28.4906		
x_1x_2	31.0223	2.5316	0.1116
x_1x_3	32.8817	4.3911	0.0361
x_2x_3	31.6062	3.1155	0.0775
x_1	38.3497	9.8591	0.0072
x_2	33.0137	4.5251	0.1041
x_3	54.9653	26.4747	<0.0001

From examining the difference in deviance between each of the subset models and the full model, we notice that deleting either x_1 or x_2 results in a two-variable model that is significantly worse than the full model. Removing x_3 results in a model that is not significantly different than the full model, but as we have already noted, x_1 is not significant in this model. This leads us to consider the one-variable models. Only one of these models, the one containing x_2 , is not significantly different from the full model. The SAS PROC GENMOD output for this model is shown in the second page of Table 13.7. The Poisson regression model for predicting damage is

$$\hat{y} = e^{-1.6491+0.2282x_2}$$

The deviance for this model is $D(\beta) = 33.0137$ with 28 degrees of freedom, and the P value is 0.2352, so we conclude that the model is an adequate fit to the data. ■

13.4 THE GENERALIZED LINEAR MODEL

All of the regression models that we have considered in the two previous sections of this chapter belong to a family of regression models called the **generalized linear model** (GLM). The GLM is actually a unifying approach to regression and experimental design models, uniting the usual normal-theory linear regression models and nonlinear models such as logistic and Poisson regression.

A key assumption in the GLM is that the response variable distribution is a member of the **exponential family** of distributions, which includes (among others) the normal, binomial, Poisson, inverse normal, exponential, and gamma distributions. Distributions that are members of the exponential family have the general form

$$f(y_i, \theta_i, \phi) = \exp\{[y_i\theta_i - b(\theta_i)]/a(\phi) + h(y_i, \phi)\} \quad (13.48)$$

where ϕ is a scale parameter and θ_i is called the natural location parameter. For members of the exponential family,

$$\begin{aligned} \mu = E(y) &= \frac{db(\theta_i)}{d\theta_i} \\ \text{Var}(y) &= \frac{d^2b(\theta_i)}{d\theta_i^2} a(\phi) = \frac{d\mu}{d\theta_i} a(\phi) \end{aligned} \quad (13.49)$$

Let

$$\text{Var}(\mu) = \frac{\text{Var}(y)}{a(\phi)} = \frac{d\mu}{d\theta_i} \quad (13.50)$$

where $\text{Var}(\mu)$ denotes the dependence of the variance of the response on its mean. This is a characteristic of all distributions that are a member of the exponential family, except for the normal distribution. As a result of Eq. (13.50), we have

$$\frac{d\theta_i}{d\mu} = \frac{1}{\text{Var}(\mu)} \quad (13.51)$$

In Appendix C.14 we show that the normal, binomial, and Poisson distributions are members of the exponential family.

13.4.1 Link Functions and Linear Predictors

The basic idea of a GLM is to develop a linear model for an appropriate function of the expected value of the response variable. Let η_i be the **linear predictor** defined by

$$\eta_i = g[E(y_i)] = g(\mu_i) = \mathbf{x}'_i \boldsymbol{\beta} \quad (13.52)$$

Note that the expected response is just

$$E(y_i) = g^{-1}(\eta_i) = g^{-1}(\mathbf{x}'_i \boldsymbol{\beta}) \quad (13.53)$$

We call the function g the **link function**. Recall that we introduced the concept of a link function in our description of Poisson regression. There are many possible choices of the link function, but if we choose

$$\eta_i = \theta_i \quad (13.54)$$

we say that η_i is the **canonical link**. Table 13.8 shows the canonical links for the most common choices of distributions employed with the GLM.

TABLE 13.8 Canonical Links for the Generalized Linear Model

Distribution	Canonical Link
Normal	$\eta_i = \mu_i$ (identity link)
Binomial	$\eta_i = \ln\left(\frac{\pi_i}{1-\pi_i}\right)$ (logistic link)
Poisson	$\eta_i = \ln(\lambda)$ (log link)
Exponential	$\eta_i = \frac{1}{\lambda_i}$ (reciprocal link)
Gamma	$\eta_i = \frac{1}{\lambda_i}$ (reciprocal link)

There are other link functions that could be used with a GLM, including:

1. The probit link,

$$\eta_i = \Phi^{-1}[E(y_i)]$$

where Φ represents the cumulative standard normal distribution function.

2. The complementary log-log link,

$$\eta_i = \ln\{\ln[1 - E(y_i)]\}$$

3. The power family link,

$$\eta_i = \begin{cases} E(y_i)^\lambda, & \lambda \neq 0 \\ \ln[E(y_i)], & \lambda = 0 \end{cases}$$

A very fundamental idea is that there are two components to a GLM: the response distribution and the link function. We can view the selection of the link function in a vein similar to the choice of a transformation on the response. However, unlike a transformation, the link function takes advantage of the **natural** distribution of the response. Just as not using an appropriate transformation can result in problems with a fitted linear model, improper choices of the link function can also result in significant problems with a GLM.

13.4.2 Parameter Estimation and Inference in the GLM

The method of maximum likelihood is the theoretical basis for parameter estimation in the GLM. However, the actual implementation of maximum likelihood results in an algorithm based on IRLS. This is exactly what we saw previously for the special cases of logistic and Poisson regression. We present the details of the procedure in Appendix C.14. In this chapter, we rely on SAS PROC GENMOD for model fitting and inference.

If $\hat{\boldsymbol{\beta}}$ is the final value of the regression coefficients that the IRLS algorithm produces and if the model assumptions, including the choice of the link function, are correct, then we can show that asymptotically

$$E(\hat{\boldsymbol{\beta}}) = \boldsymbol{\beta} \quad \text{and} \quad \text{Var}(\hat{\boldsymbol{\beta}}) = a(\phi)(\mathbf{X}'\mathbf{V}\mathbf{X})^{-1} \quad (13.55)$$

where the matrix \mathbf{V} is a diagonal matrix formed from the variances of the estimated parameters in the linear predictor, apart from $a(\phi)$.

Some important observations about the GLM are as follows:

1. Typically, when experimenters and data analysts use a transformation, they use OLS to actually fit the model in the transformed scale.
2. In a GLM, we recognize that the variance of the response is not constant, and we use weighted least squares as the basis of parameter estimation.

3. This suggests that a GLM should outperform standard analyses using transformations when a problem remains with constant variance after taking the transformation.
4. All of the inference we described previously on logistic regression carries over directly to the GLM. That is, model deviance can be used to test for overall model fit, and the difference in deviance between a full and a reduced model can be used to test hypotheses about subsets of parameters in the model. Wald inference can be applied to test hypotheses and construct confidence intervals about individual model parameters.

Example 13.9 The Worsted Yarn Experiment

Table 13.9 contains data from an experiment conducted to investigate the three factors $x_1 = \text{length}$, $x_2 = \text{amplitude}$, and $x_3 = \text{load}$ on the cycles to failure y of worsted yarn. The regressor variables are coded, and readers who have familiarity with designed experiments will recognize that the experimenters here used a 3^3 factorial design. The data also appear in Box and Draper [1987] and Myers, Montgomery, and Anderson-Cook [2009]. These authors use the data to illustrate the utility of variance-stabilizing

TABLE 13.9 Data from the Worsted Yarn Experiment

x_1	x_2	x_3	y
-1	-1	-1	674
0	-1	-1	1414
1	-1	-1	3636
-1	0	-1	338
0	0	-1	1022
1	0	-1	1568
-1	1	-1	170
0	1	-1	442
1	1	-1	1140
-1	-1	0	370
0	-1	0	1198
1	-1	0	3184
-1	0	0	266
0	0	0	620
1	0	0	1070
-1	1	0	118
0	1	0	332
1	1	0	884
-1	-1	1	292
0	-1	1	634
1	-1	1	2000
-1	0	1	210
0	0	1	438
1	0	1	566
-1	1	1	90
0	1	1	220
1	1	1	360

transformations. Both Box and Draper [1987] and Myers, Montgomery, and Anderson-Cook [2009] show that the log transformation is very effective in stabilizing the variance of the cycles-to-failure response. The least-squares model is

$$\hat{y} = \exp(6.33 + 0.83x_1 - 0.63x_2 - 0.39x_3)$$

The response variable in this experiment is an example of a nonnegative response that would be expected to have an asymmetric distribution with a long right tail. Failure data are frequently modeled with exponential, Weibull, lognormal, or gamma distributions both because they possess the anticipated shape and because sometimes there is theoretical or empirical justification for a particular distribution.

We will model the cycles-to-failure data with a GLM using the gamma distribution and the log link. From Table 13.8 we observe that the canonical link here is the inverse link; however, the log link is often a very effective choice with the gamma distribution.

Table 13.10 presents some summary output information from SAS PROC GENMOD for the worsted yarn data. The appropriate SAS code is

```
proc genmod;
model y = x1 x2 x3 / dist = gamma link = log type1 type3;
```

Notice that the fitted model is

$$\hat{y} = \exp(6.35 + 0.84x_1 - 0.63x_2 - 0.39x_3)$$

which is virtually identical to the model obtained via data transformation. Actually, since the log transformation works very well here, it is not too surprising that the GLM produces an almost identical model. Recall that we observed that the GLM is most likely to be an effective alternative to a data transformation when the transformation fails to produce the desired properties of constant variance and approximate normality in the response variable.

For the gamma response case, it is appropriate to use the **scaled deviance** in the SAS output as a measure of the overall fit of the model. This quantity would be compared to the chi-square distribution with $n - p$ degrees of freedom, as usual. From Table 13.10 we find that the scaled deviance is 27.1276, and referring this to a chi-square distribution with 23 degrees of freedom gives a P value of approximately 0.25, so there is no indication of model inadequacy from the deviance criterion. Notice that the scaled deviance divided by its degrees of freedom is also close to unity. Table 13.10 also gives the Wald tests and the partial deviance statistics (both type 1 or “effects added in order” and type 3 or “effects added last” analyses) for each regressor in the model. These test statistics indicate that all three regressors are important predictors and should be included in the model. ■

13.4.3 Prediction and Estimation with the GLM

For any generalized linear model, the estimate of the mean response at some point of interest, say \mathbf{x}_0 , is

$$\hat{y}_0 = \hat{\mu}_0 = g^{-1}(\mathbf{x}'_0 \hat{\boldsymbol{\beta}}) \quad (13.56)$$

TABLE 13.10 SAS PROC GENMOD Output for the Worsted Yarn Experiment

The GENMOD Procedure

Model Information

Description	Value
Data Set	WORK.WOOL
Distribution	GAMMA
Link Function	LOG
Dependent Variable	CYCLES
Observations Used	27

Criteria for Assessing Goodness of Fit

Criterion	DF	Value	Value/DF
Deviance	23	0.7694	0.0335
Scaled Deviance	23	27.1276	1.1795
Pearson Chi [Square	23	0.7274	0.0316
Scaled Pearson X2	23	25.6456	1.1150
Log Likelihood		-161.3784	

Analysis of Parameter Estimates

.Parameter	DF	Estimate	Std Err	Chi Square	Pr > Chi
INTERCEPT	1	6.3489	0.0324	38373.0419	0.0001
A	1	0.8425	0.0402	438.3606	0.0001
B	1	-0.6313	0.0396	253.7576	0.0001
C	1	-0.3851	0.0402	91.8566	0.0001
SCALE	1	35.2585	9.5511		

Note: The scale parameter was estimated by maximum likelihood.

LR Statistics for Type 1 Analysis

.Source	Deviance	DF	Chi Square	Pr > Chi
INTERCEPT	22.8861	0		
A	10.2104	1	23.6755	0.0001
B	3.3459	1	31.2171	0.0001
C	0.7694	1	40.1106	0.0001

LR Statistics for Type 3 Analysis

Source	DF	Chi Square	Pr > Chi
A	1	77.2935	0.0001
B	1	63.4324	0.0001
C	1	40.1106	0.0001

where g is the link function and it is understood that \mathbf{x}_0 may be expanded to model form if necessary to accommodate terms such as interactions that may have been included in the linear predictor. An approximate confidence interval on the mean response at this point can be computed as follows. Let Σ be the asymptotic variance-covariance matrix for $\hat{\beta}$; thus,

$$\Sigma = a(\phi)(\mathbf{X}'\mathbf{V}\mathbf{X})^{-1}$$

The asymptotic variance of the estimated linear predictor at \mathbf{x}_0 is

$$\text{Var}(\hat{\eta}_0) = \text{Var}(\mathbf{x}'_0 \hat{\boldsymbol{\beta}}) = \mathbf{x}'_0 \boldsymbol{\Sigma} \mathbf{x}_0$$

Thus, an estimate of this variance is $\mathbf{x}'_0 \hat{\boldsymbol{\Sigma}} \mathbf{x}_0$, where $\hat{\boldsymbol{\Sigma}}$ is the estimated variance-covariance matrix of $\hat{\boldsymbol{\beta}}$. The $100(1 - \alpha)$ percent confidence interval on the true mean response at the point \mathbf{x}_0 is

$$L \leq \mu(\mathbf{x}_0) \leq U \quad (13.57)$$

where

$$L = g^{-1}(\mathbf{x}'_0 \hat{\boldsymbol{\beta}} - Z_{\alpha/2} \mathbf{x}'_0 \hat{\boldsymbol{\Sigma}} \mathbf{x}_0) \quad \text{and} \quad U = g^{-1}(\mathbf{x}'_0 \hat{\boldsymbol{\beta}} + Z_{\alpha/2} \mathbf{x}'_0 \hat{\boldsymbol{\Sigma}} \mathbf{x}_0) \quad (13.58)$$

This method is used to compute the confidence intervals on the mean response reported in SAS PROC GENMOD. This method for finding the confidence intervals usually works well in practice, because $\hat{\boldsymbol{\beta}}$ is a maximum-likelihood estimate, and therefore any function of $\hat{\boldsymbol{\beta}}$ is also a maximum-likelihood estimate. The above procedure simply constructs a confidence interval in the space defined by the linear predictor and then transforms that interval back to the original metric.

It is also possible to use Wald inference to derive other expressions for approximate confidence intervals on the mean response. Refer to Myers, Montgomery, and Anderson-Cook [2009] for the details.

Example 13.10 The Worst Yarn Experiment

Table 13.11 presents three sets of confidence intervals on the mean response for the worsted yarn experiment originally described in Example 13.10. In this table, we have shown 95% confidence intervals on the mean response for all 27 points in the original experimental data for three models: the least-squares model in the log scale, the untransformed response from this least-squares model, and the GLM (gamma response distribution and log link). The GLM confidence intervals were computed from Eq. (13.58). The last two columns of Table 13.11 compare the lengths of the normal-theory least-squares confidence intervals from the untransformed response to those from the GLM. Notice that the lengths of the GLM intervals are uniformly shorter than those from the least-squares analysis based on transformations. So even though the prediction equations produced by these two techniques are very similar (as we noted in Example 13.9), there is some evidence to indicate that the predictions obtained from the GLM are more precise in the sense that the confidence intervals will be shorter. ■

13.4.4 Residual Analysis in the GLM

Just as in any model-fitting procedure, analysis of residuals is important in fitting the GLM. Residuals can provide guidance concerning the overall adequacy of the model, assist in verifying assumptions, and give an indication concerning the appropriateness of the selected link function.

TABLE 13.11 Comparison of 95% Confidence Intervals on the Mean Response for the Worstest Yarn Data

Obs.	Using Least-Squares Methods with Log Data Transformation						Using the Generalized Linear Model		Length of the 95% Confidence Interval	
	Transformed			Untransformed			Predicted Value	95% Confidence Interval	Least Squares	GLM
	Predicted Value	95% Confidence Interval		Predicted Value	95% Confidence Interval					
1	2.83	(2.76, 2.91)	682.50	680.52	(573.85, 811.52)	680.52	(583.83, 793.22)	237.67	209.39	
2	2.66	(2.60, 2.73)	460.26	463.00	(397.01, 533.46)	463.00	(407.05, 526.64)	136.45	119.50	
3	2.49	(2.42, 2.57)	310.38	315.01	(260.98, 369.06)	315.01	(271.49, 365.49)	108.09	94.00	
4	2.56	(2.50, 2.62)	363.25	361.96	(313.33, 421.11)	361.96	(317.75, 412.33)	107.79	94.58	
5	2.39	(2.34, 2.44)	244.96	246.26	(217.92, 275.30)	246.26	(222.55, 272.51)	57.37	49.96	
6	2.22	(2.15, 2.28)	165.20	167.55	(142.50, 191.47)	167.55	(147.67, 190.10)	48.97	42.42	
7	2.29	(2.21, 2.36)	193.33	192.52	(162.55, 229.93)	192.52	(165.69, 223.70)	67.38	58.01	
8	2.12	(2.05, 2.18)	130.38	130.98	(112.46, 151.15)	130.98	(115.43, 148.64)	38.69	33.22	
9	1.94	(1.87, 2.02)	87.92	89.12	(73.93, 104.54)	89.12	(76.87, 103.32)	30.62	26.45	
10	3.20	(3.13, 3.26)	1569.28	1580.00	(1353.94, 1819.28)	1580.00	(1390.00, 1797.00)	465.34	407.00	
11	3.02	(2.97, 3.08)	1058.28	1075.00	(941.67, 1189.60)	1075.00	(972.52, 1189.00)	247.92	216.48	
12	2.85	(2.79, 2.92)	713.67	731.50	(615.60, 827.37)	731.50	(644.35, 830.44)	211.77	186.09	
13	2.92	(2.87, 2.97)	835.41	840.54	(743.19, 938.86)	840.54	(759.65, 930.04)	195.67	170.39	
14	2.75	(2.72, 2.78)	563.25	571.87	(523.24, 606.46)	571.87	(536.67, 609.38)	83.22	72.70	
15	2.58	(2.63, 2.63)	379.84	389.08	(337.99, 426.97)	389.08	(351.64, 430.51)	88.99	78.87	
16	2.65	(2.58, 2.71)	444.63	447.07	(383.53, 515.35)	447.07	(393.81, 507.54)	131.82	113.74	
17	2.48	(2.43, 2.53)	299.85	304.17	(266.75, 336.98)	304.17	(275.13, 336.28)	70.23	61.15	
18	2.31	(2.24, 2.37)	202.16	206.95	(174.42, 234.37)	206.95	(182.03, 235.27)	59.95	53.23	
19	3.56	(3.48, 3.63)	3609.11	3670.00	(3034.59, 4292.40)	3670.00	(3165.00, 4254.00)	1257.81	1089.00	
20	3.39	(3.32, 3.45)	2433.88	2497.00	(2099.42, 2821.63)	2497.00	(2200.00, 2833.00)	722.21	633.00	
21	3.22	(3.14, 3.29)	1641.35	1699.00	(1380.07, 1951.64)	1699.00	(1462.00, 1974.00)	571.57	512.00	
22	3.28	(3.22, 3.35)	1920.88	1952.00	(1656.91, 2226.90)	1952.00	(1720.00, 2215.00)	569.98	495.00	
23	3.11	(3.06, 3.16)	1295.39	1328.00	(1152.66, 1455.79)	1328.00	(1200.00, 1470.00)	303.14	270.00	
24	2.94	(2.88, 3.01)	873.57	903.51	(753.53, 1012.74)	903.51	(793.15, 1029.00)	259.22	235.85	
25	3.01	(2.93, 3.08)	1022.35	1038.00	(859.81, 1215.91)	1038.00	(894.79, 1205.00)	356.10	310.21	
26	2.84	(2.77, 2.90)	689.45	706.34	(594.70, 799.28)	706.34	(620.99, 803.43)	204.58	182.44	
27	2.67	(2.59, 2.74)	464.94	480.57	(390.93, 552.97)	480.57	(412.29, 560.15)	162.04	147.86	

The ordinary or **raw residuals** from the GLM are just the differences between the observations and the fitted values,

$$e_i = y_i - \hat{y}_i = y_i - \hat{\mu}_i \quad (13.59)$$

It is generally recommended that residual analysis in the GLM be performed using **deviance residuals**. Recall that the i th deviance residual is defined as the square root of the contribution of the i th observation to the deviance multiplied by the sign of the ordinary residual. Equation (13.30) gave the deviance residual for logistic regression. For Poisson regression with a log link, the deviance residuals are

$$d_i = \pm \left[y_i \ln \left(\frac{y_i}{e^{x_i \hat{\beta}}} \right) - (y_i - e^{x_i \hat{\beta}}) \right]^{1/2}, \quad i = 1, 2, \dots, n$$

where the sign is the sign of the ordinary residual. Notice that as the observed value of the response y_i and the predicted value $\hat{y}_i = e^{x_i \hat{\beta}}$ become closer to each other, the deviance residuals approach zero.

Generally, deviance residuals behave much like ordinary residuals do in a standard normal-theory linear regression model. Thus, plotting the deviance residuals on a normal probability scale and versus fitted values is a logical diagnostic. When plotting deviance residuals versus fitted values, it is customary to transform the fitted values to a constant information scale. Thus,

1. For normal responses, use \hat{y}_i .
2. For binomial responses, use $2 \sin^{-1} \sqrt{\hat{\pi}_i}$.
3. For Poisson responses, use $2 \sqrt{\hat{y}_i}$.
4. For gamma responses, use $2 \ln(\hat{y}_i)$.

Example 13.11 The Worst Yarn Experiment

Table 13.12 presents the actual observations from the worsted yarn experiment in Example 13.9, along with the predicted values from the GLM (gamma response with log link) that was fit to the data, the raw residuals, and the deviance residuals. These quantities were computed using SAS PROC GENMOD. Figure 13.7a is a normal probability plot of the deviance residuals and Figure 13.7b is a plot of the deviance residuals versus the “constant information” fitted values, $2 \ln(\hat{y}_i)$. The normal probability plot of the deviance residuals is generally satisfactory, while the plot of the deviance residuals versus the fitted values indicates that one of the observations may be a very mild outlier. Neither plot gives any significant indication of model inadequacy, however, so we conclude that the GLM with gamma response variable distribution and a log link is a very satisfactory model for the cycles-to-failure response. ■

13.4.5 Using R to Perform GLM Analysis

The workhorse routine within R for analyzing a GLM is “glm.” The basic form of this statement is:

TABLE 13.12 Predicted Values and Residuals from the Worsted Yarn Experiment

Response y_i	Predicted \hat{y}	Linear Predictor $\mathbf{x}'\boldsymbol{\beta}$	e_i	d_i
674	680.5198	6.5229	-6.5198	-0.009611
370	462.9981	6.1377	-92.9981	-0.2161
292	315.0052	5.7526	-23.0052	-0.0749
338	361.9609	5.8915	-23.9609	-0.0677
266	246.2636	5.5064	19.7364	0.0781
210	167.5478	5.1213	42.4522	0.2347
170	192.5230	5.2602	-22.5230	-0.1219
118	130.9849	4.8751	-12.9849	-0.1026
90	89.1168	4.4899	0.8832	0.009878
1414	1580.2950	7.3654	-166.2950	-0.1092
1198	1075.1687	6.9802	122.8313	0.1102
634	731.5013	6.5951	-97.5013	-0.1397
1022	840.5414	6.7340	181.4586	0.2021
620	571.8704	6.3489	48.1296	0.0819
438	389.0774	5.9638	48.9226	0.1208
442	447.0747	6.1027	-5.0747	-0.0114
332	304.1715	5.7176	27.8285	0.0888
220	206.9460	5.3325	13.0540	0.0618
3636	3669.7424	8.2079	-33.7424	-0.009223
3184	2496.7442	7.8227	687.2558	0.2534
2000	1698.6836	7.4376	301.3164	0.1679
1568	1951.8954	7.5766	-383.8954	-0.2113
1070	1327.9906	7.1914	-257.9906	-0.2085
566	903.5111	6.8063	-337.5111	-0.4339
1140	1038.1916	6.9452	101.8084	0.0950
884	706.3435	6.5601	177.6565	0.2331
360	480.5675	6.1750	-120.5675	-0.2756

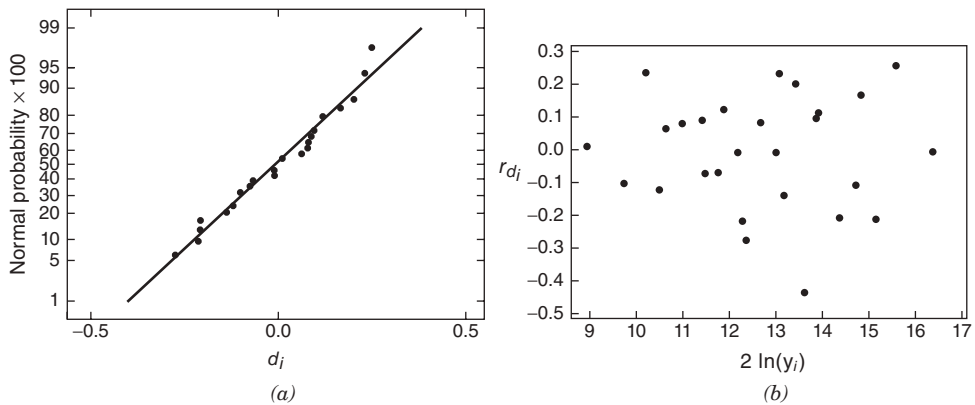

Figure 13.7 Plots of the deviance residuals from the GLM for the worsted yarn data. (a) Normal probability plot of deviance results. (b) Plot of the deviance residuals versus $2\ln(\hat{y}_i)$

```
glm(formula, family, data)
```

The formula specification is exactly the same as for a standard linear model. For example, the formula for the model $\eta = \beta_0 + \beta_1x_1 + \beta_2x_2$ is

```
y ~ x1+x2
```

The choices for family and the links available are:

- binomial (logit, probit, log, complementary loglog),
- gaussian (identity, log, inverse),
- Gamma (identity, inverse, log)
- inverse.gaussian ($1/\mu^2$, identity, inverse, log)
- poisson (identity, log, square root), and
- quasi (logit, probit, complementary loglog, identity, inverse, log, $1/\mu^2$, square root).

R is case-sensitive, so the family is Gamma, not gamma. By default, R uses the canonical link. To specify the probit link for the binomial family, the appropriate family phrase is binomial (link = probit).

R can produce two different predicted values. The “fit” is the vector of predicted values on the original scale. The “linear.predictor” is the vector of the predicted values for the linear predictor. R can produce the raw, the Pearson, and the deviance residuals. R also can produce the “influence measures,” which are the individual observation deleted statistics. The easiest way to put all this together is through examples.

We first consider the pneumoconiosis data from Example 13.1. The data set is small, so we do not need a separate data file. The R code is:

```
> years <- c(5.8, 15.0, 21.5, 27.5, 33.5, 39.5, 46.0, 51.5)
> cases <- c(0, 1, 3, 8, 9, 8, 10, 5)
> miners <- c(98, 54, 43, 48, 51, 38, 28, 11)
> ymat <- cbind(cases, miners-cases)
> ashford <- data.frame(ymat, years)
> anal <- glm(ymat ~ years, family=binomial, data=ashford)
summary(anal)
pred_prob <- anal$fit
eta_hat <- anal$linear.predictor
dev_res <- residuals(anal, c="deviance")
influence.measures(anal)
df <- dfbetas(anal)
df_int <- df[,1]
df_years <- df[,2]
hat <- hatvalues(anal)
qqnorm(dev_res)
plot(pred_prob, dev_res)
plot(eta_hat, dev_res)
```

```

plot(years, dev_res)
plot(hat, dev_res)
plot(pred_prob, df_years)
plot(hat, df_years)
ashford2 <- cbind(ashford, pred_prob, eta_hat, dev_res, df_int,
df_years, hat)
write.table(ashford2, "ashford_output.txt")

```

We next consider the Aircraft Damage example from Example 13.8. The data are in the file `aircraft_damage_data.txt`. The appropriate R code is

```

air <- read.table("aircraft_damage_data.txt", header=TRUE, sep="")
air.model <- glm(y~x1+x2+x3, dist="poisson", data=air)
summary(air.model)
print(influence.measures(air.model))
yhat <- air.model$fit
dev_res <- residuals(air.model, c="deviance")
qqnorm(dev_res)
plot(yhat, dev_res)
plot(air$x1, dev_res)
plot(air$x2, dev_res)
plot(air$x3, dev_res)
air2 <- cbind(air, yhat, dev_res)
write.table(air2, "aircraft_damage_output.txt")

```

Finally, consider the Worstest Yarn example from Example 13.9. The data are in the file `worsted_data.txt`. The appropriate R code is

```

yarn <- read.table("worsted_data.txt", header=TRUE, sep="")
yarn.model <- glm(y~x1+x2+x3, dist=Gamma(link=log), data=air)
summary(yarn.model)
print(influence.measures(yarn.model))
yhat <- air.model$fit
dev_res <- residuals(yarn.model, c="deviance")
qqnorm(dev_res)
plot(yhat, dev_res)
plot(yarn$x1, dev_res)
plot(yarn$x2, dev_res)
plot(yarn$x3, dev_res)
yarn2 <- cbind(yarn, yhat, dev_res)
write.table(yarn2, "yarn_output.txt")

```

13.4.6 Overdispersion

Overdispersion is a phenomenon that sometimes occurs when we are modeling response data with either a binomial or Poisson distribution. Basically, it means that the variance of the response is greater than one would anticipate for that choice of

response distribution. An overdispersion condition is often diagnosed by evaluating the value of model deviance divided by degrees of freedom. If this value greatly exceeds unity, then overdispersion is a possible source of concern.

The most direct way to model this situation is to allow the variance function of the binomial or Poisson distributions to have a multiplicative dispersion factor ϕ , so that

$$\text{Var}(y) = \phi\mu(1-\mu) \quad \text{binomial distribution}$$

$$\text{Var}(y) = \phi\mu \quad \text{Poisson distribution}$$

The models are fit in the usual manner, and the values of the model parameters are not affected by the value of ϕ . The parameter ϕ can be specified directly if its value is known or it can be estimated if there is replication of some data points. Alternatively, it can be directly estimated. A logical estimate for ϕ is the deviance divided by its degrees of freedom. The covariance matrix of model coefficients is multiplied by ϕ and the scaled deviance and log-likelihoods used in hypothesis testing are divided by ϕ .

The function obtained by dividing a log-likelihood by ϕ for the binomial or Poisson error distribution case is no longer a proper log-likelihood function. It is an example of a **quasi-likelihood function**. Fortunately, most of the asymptotic theory for log-likelihoods applies to quasi-likelihoods, so we can justify computing approximate standard errors and deviance statistics just as we have done previously.

PROBLEMS

13.1 The table below presents the test-firing results for 25 surface-to-air anti-aircraft missiles at targets of varying speed. The result of each test is either a hit ($y = 1$) or a miss ($y = 0$).

Test	Target Speed, x (knots)	y	Test	Target Speed, x (knots)	y
1	400	0	14	330	1
2	220	1	15	280	1
3	490	0	16	210	1
4	210	1	17	300	1
5	500	0	18	470	1
6	270	0	19	230	0
7	200	1	20	430	0
8	470	0	21	460	0
9	480	0	22	220	1
10	310	1	23	250	1
11	240	1	24	200	1
12	490	0	25	390	0
13	420	0			

- Fit a logistic regression model to the response variable y . Use a simple linear regression model as the structure for the linear predictor.
- Does the model deviance indicate that the logistic regression model from part a is adequate?

- c. Provide an interpretation of the parameter β_1 in this model.
- d. Expand the linear predictor to include a quadratic term in target speed. Is there any evidence that this quadratic term is required in the model?

13.2 A study was conducted attempting to relate home ownership to family income. Twenty households were selected and family income was estimated, along with information concerning home ownership ($y = 1$ indicates yes and $y = 0$ indicates no). The data are shown below.

Household	Income	Home Ownership Status	Household	Income	Home Ownership Status
1	38,000	0	11	38,700	1
2	51,200	1	12	40,100	0
3	39,600	0	13	49,500	1
4	43,400	1	14	38,000	0
5	47,700	0	15	42,000	1
6	53,000	0	16	54,000	1
7	41,500	1	17	51,700	1
8	40,800	0	18	39,400	0
9	45,400	1	19	40,900	0
10	52,400	1	20	52,800	1

- a. Fit a logistic regression model to the response variable y . Use a simple linear regression model as the structure for the linear predictor.
- b. Does the model deviance indicate that the logistic regression model from part a is adequate?
- c. Provide an interpretation of the parameter β_1 in this model.
- d. Expand the linear predictor to include a quadratic term in income. Is there any evidence that this quadratic term is required in the model?

13.3 The compressive strength of an alloy fastener used in aircraft construction is being studied. Ten loads were selected over the range 2500–4300 psi and a number of fasteners were tested at those loads. The numbers of fasteners failing at each load were recorded. The complete test data are shown below.

Load, x (psi)	Sample Size, n	Number Failing, r
2500	50	10
2700	70	17
2900	100	30
3100	60	21
3300	40	18
3500	85	43
3700	90	54
3900	50	33
4100	80	60
4300	65	51

- a. Fit a logistic regression model to the data. Use a simple linear regression model as the structure for the linear predictor.
- b. Does the model deviance indicate that the logistic regression model from part a is adequate?
- c. Expand the linear predictor to include a quadratic term. Is there any evidence that this quadratic term is required in the model?
- d. For the quadratic model in part c, find Wald statistics for each individual model parameter.
- e. Find approximate 95% confidence intervals on the model parameters for the quadratic model from part c.

13.4 The market research department of a soft drink manufacturer is investigating the effectiveness of a price discount coupon on the purchase of a two-liter beverage product. A sample of 5500 customers was given coupons for varying price discounts between 5 and 25 cents. The response variable was the number of coupons in each price discount category redeemed after one month. The data are shown below.

Discount, x	Sample Size, n	Number Redeemed, r
5	500	100
7	500	122
9	500	147
11	500	176
13	500	211
15	500	244
17	500	277
19	500	310
21	500	343
23	500	372
25	500	391

- a. Fit a logistic regression model to the data. Use a simple linear regression model as the structure for the linear predictor.
- b. Does the model deviance indicate that the logistic regression model from part a is adequate?
- c. Draw a graph of the data and the fitted logistic regression model.
- d. Expand the linear predictor to include a quadratic term. Is there any evidence that this quadratic term is required in the model?
- e. Draw a graph of this new model on the same plot that you prepared in part c. Does the expanded model visually provide a better fit to the data than the original model from part a?
- f. For the quadratic model in part d, find Wald statistics for each individual model parameter.
- g. Find approximate 95% confidence intervals on the model parameters for the quadratic logistic regression model from part d.

13.5 A study was performed to investigate new automobile purchases. A sample of 20 families was selected. Each family was surveyed to determine the age of their oldest vehicle and their total family income. A follow-up survey was conducted 6 months later to determine if they had actually purchased a new vehicle during that time period ($y = 1$ indicates yes and $y = 0$ indicates no). The data from this study are shown in the following table.

Income, x_1	Age, x_2	y	Income, x_1	Age, x_2	y
45,000	2	0	37,000	5	1
40,000	4	0	31,000	7	1
60,000	3	1	40,000	4	1
50,000	2	1	75,000	2	0
55,000	2	0	43,000	9	1
50,000	5	1	49,000	2	0
35,000	7	1	37,500	4	1
65,000	2	1	71,000	1	0
53,000	2	0	34,000	5	0
48,000	1	0	27,000	6	0

- a. Fit a logistic regression model to the data.
- b. Does the model deviance indicate that the logistic regression model from part a is adequate?
- c. Interpret the model coefficients β_1 and β_2 .
- d. What is the estimated probability that a family with an income of \$45,000 and a car that is 5 years old will purchase a new vehicle in the next 6 months?
- e. Expand the linear predictor to include an interaction term. Is there any evidence that this term is required in the model?
- f. For the model in part a, find statistics for each individual model parameter.
- g. Find approximate 95% confidence intervals on the model parameters for the logistic regression model from part a.

13.6 A chemical manufacturer has maintained records on the number of failures of a particular type of valve used in its processing unit and the length of time (months) since the valve was installed. The data are shown below.

Valve	Number of Failures	Months	Valve	Number of Failures	Months
1	5	18	9	0	7
2	3	15	10	0	12
3	0	11	11	0	3
4	1	14	12	1	7
5	4	23	13	0	2
6	0	10	14	7	30
7	0	5	15	0	9
8	1	8			

- a. Fit a Poisson regression model to the data.
- b. Does the model deviance indicate that the Poisson regression model from part a is adequate?
- c. Construct a graph of the fitted model versus months. Also plot the observed number of failures on this graph.
- d. Expand the linear predictor to include a quadratic term. Is there any evidence that this term is required in the model?
- e. For the model in part a, find Wald statistics for each individual model parameter.
- f. Find approximate 95% confidence intervals on the model parameters for the Poisson regression model from part a.

13.7 Myers [1990] presents data on the number of fractures (y) that occur in the upper seams of coal mines in the Appalachian region of western Virginia. Four regressors were reported: x_1 = inner burden thickness (feet), the shortest distance between seam floor and the lower seam; x_2 = percent extraction of the lower previously mined seam; x_3 = lower seam height (feet); and x_4 = time (years) that the mine has been in operation. The data are shown below.

Observation	Number of Fractures per Subregion, y				
	x_1	x_2	x_3	x_4	
1	2	50	70	52	1.0
2	1	230	65	42	6.9
3	0	125	70	45	1.0
4	4	75	65	68	0.5
5	1	70	65	53	0.5
6	2	65	70	46	3.0
7	0	65	60	62	1.0
8	0	350	60	54	0.5
9	4	350	90	54	0.5
10	4	160	80	38	0.0
11	1	145	65	38	10.0
12	4	145	85	38	0.0
13	1	180	70	42	2.0
14	5	43	80	40	0.0
15	2	42	85	51	12.0
16	5	42	85	51	0.0
17	5	45	85	42	0.0
18	5	83	85	48	10.0
19	0	300	65	68	10.0
20	5	190	90	84	6.0
21	1	145	90	54	12.0
22	1	510	80	57	10.0
23	3	65	75	68	5.0
24	3	470	90	90	9.0
25	2	300	80	165	9.0
26	2	275	90	40	4.0
27	0	420	50	44	17.0
28	1	65	80	48	15.0

Observation	Number of Fractures per Subregion, y				
	x_1	x_2	x_3	x_4	
29	5	40	75	51	15.0
30	2	900	90	48	35.0
31	3	95	88	36	20.0
32	3	40	85	57	10.0
33	3	140	90	38	7.0
34	0	150	50	44	5.0
35	0	80	60	96	5.0
36	2	80	85	96	5.0
37	0	145	65	72	9.0
38	0	100	65	72	9.0
39	3	150	80	48	3.0
40	2	150	80	48	0.0
41	3	210	75	42	2.0
42	5	11	75	42	0.0
43	0	100	65	60	25.0
44	3	50	88	60	20.0

- a. Fit a Poisson regression model to these data using the log link.
 - b. Does the model deviance indicate that the model from part a is satisfactory?
 - c. Perform a type 3 partial deviance analysis of the model parameters. Does this indicate that any regressors could be removed from the model?
 - d. Compute Wald statistics for testing the contribution of each regressor to the model. Interpret the results of these test statistics.
 - e. Find approximate 95% Wald confidence intervals on the model parameters.
- 13.8** Reconsider the mine fracture data from Problem 13.7. Remove any regressors from the original model that you think might be unimportant and rework parts b–e of Problem 13.7. Comment on your findings.
- 13.9** Reconsider the mine fracture data from Problems 13.7 and 13.8. Construct plots of the deviance residuals from the best model you found and comment on the plots. Does the model appear satisfactory from a residual analysis viewpoint?
- 13.10** Reconsider the model for the automobile purchase data from Problem 13.5, part a. Construct plots of the deviance residuals from the model and comment on these plots. Does the model appear satisfactory from a residual analysis viewpoint?
- 13.11** Reconsider the model for the soft drink coupon data from Problem 13.4, part a. Construct plots of the deviance residuals from the model and comment on these plots. Does the model appear satisfactory from a residual analysis viewpoint?
- 13.12** Reconsider the model for the aircraft fastener data from Problem 13.3, part a. Construct plots of the deviance residuals from the model and comment

on these plots. Does the model appear satisfactory from a residual analysis viewpoint?

13.13 The gamma probability density function is

$$f(y, r, \lambda) = \frac{\lambda^r}{\Gamma(r)} e^{-\lambda y} y^{r-1} \quad \text{for } y, \lambda \geq 0$$

Show that the gamma is a member of the exponential family.

13.14 The exponential probability density function is

$$f(y, \lambda) = \lambda e^{-\lambda y} \quad \text{for } y, \lambda \geq 0$$

Show that the exponential distribution is a member of the exponential family.

13.15 The negative binomial probability mass function is

$$f(y, \pi, \alpha) = \binom{y + \alpha - 1}{\alpha - 1} \pi^\alpha (1 - \pi)^y$$

$$\text{for } y = 0, 1, 2, \dots, \alpha > 0 \quad \text{and } 0 \leq \pi \leq 1$$

Show that the negative binomial is a member of the exponential family.

13.16 The data in the table below are from an experiment designed to study the advance rate y of a drill. The four design factors are $x_1 =$ load, $x_2 =$ flow, $x_3 =$ drilling speed, and $x_4 =$ type of drilling mud (the original experiment is described by Cuthbert Daniel in his 1976 book on industrial experimentation).

Observation	x_1	x_2	x_3	x_4	Advance Rate, y
1	-	-	-	-	1.68
2	+	-	-	-	1.98
3	-	+	-	-	3.28
4	+	+	-	-	3.44
5	-	-	+	-	4.98
6	+	-	+	-	5.70
7	-	+	+	-	9.97
8	+	+	+	-	9.07
9	-	-	-	+	2.07
10	+	-	-	+	2.44
11	-	+	-	+	4.09
12	+	+	-	+	4.53
13	-	-	+	+	7.77
14	+	-	+	+	9.43
15	-	+	+	+	11.75
16	+	+	+	+	16.30

- a. Fit a generalized linear model to the advance rate response. Use a gamma response distribution and a log link, and include all four regressors in the linear predictor.
 - b. Find the model deviance for the GLM from part a. Does this indicate that the model is satisfactory?
 - c. Perform a type 3 partial deviance analysis of the model parameters. Does this indicate that any regressors could be removed from the model?
 - d. Compute Wald statistics for testing the contribution of each regressor to the model. Interpret the results of these test statistics.
 - e. Find approximate 95% Wald confidence intervals on the model parameters.
- 13.17** Reconsider the drill data from Problem 13.16. Remove any regressors from the original model that you think might be unimportant and rework parts b–e of Problem 13.16. Comment on your findings.
- 13.18** Reconsider the drill data from Problem 13.16. Fit a GLM using the log link and the gamma distribution, but expand the linear predictor to include all six of the two-factor interactions involving the four original regressors. Compare the model deviance for this model to the model deviance for the “main effects only model” from Problem 13.16. Does adding the interaction terms seem useful?
- 13.19** Reconsider the model for the drill data from Problem 13.16. Construct plots of the deviance residuals from the model and comment on these plots. Does the model appear satisfactory from a residual analysis viewpoint?
- 13.20** The table below shows the predicted values and deviance residuals for the Poisson regression model using $x_2 = \text{bomb load}$ as the regressor fit to the aircraft damage data in Example 13.8. Plot the residuals and comment on model adequacy.

y	\hat{y}	$\mathbf{x}'\hat{\boldsymbol{\beta}}$	e_i	r_{pi}
0	0.4789	-0.7364	-0.4789	-0.9786
1	0.4789	-0.7364	0.5211	0.6561
0	0.4789	-0.7364	-0.4789	-0.9786
0	0.6016	-0.5083	-0.6016	-1.0969
0	0.6016	-0.5082	-0.6016	-1.0969
0	0.6016	-0.5082	-0.6016	-1.0969
1	0.7558	-0.2800	0.2442	0.2675
0	0.7558	-0.2800	-0.7558	-1.2295
0	0.7558	-0.2800	-0.7558	-1.2295
2	0.9495	-0.0518	1.0505	0.9374
0	0.9495	-0.0518	-0.9495	-1.3781
1	0.9495	-0.0518	0.0505	0.0513
1	1.1929	0.1764	-0.1929	-0.1818

(Continued)

y	\hat{y}	$\mathbf{x}'\hat{\boldsymbol{\beta}}$	e_i	r_{pi}
1	1.1929	0.1764	-0.1929	-0.1818
2	1.1929	0.1764	0.8071	0.6729
3	0.9495	-0.0518	2.0505	1.6737
1	0.9495	-0.0518	0.0505	0.0513
1	0.9495	-0.0518	0.0505	0.0513
1	1.8829	0.6328	-0.8829	-0.7072
2	1.8829	0.6328	0.1171	0.0845
0	1.8829	0.6328	-1.8829	-1.9406
1	2.9719	1.0892	-1.9719	-1.3287
1	2.9719	1.0892	-1.9719	-1.3287
2	2.9719	1.0892	-0.9719	-0.5996
5	1.1929	0.1764	3.8071	2.5915
1	1.1929	0.1764	-0.1929	-0.1818
3	1.1929	0.1764	1.8071	1.3853
5	4.6907	1.5456	0.3093	0.1413
5	4.6907	1.5456	0.3093	0.1413
7	4.6907	1.5456	2.3093	0.9930

- 13.21** Consider a logistic regression model with a linear predictor that includes an interaction term, say $\mathbf{x}'\boldsymbol{\beta} = \beta_0 + \beta_1x_1 + \beta_2x_2 + \beta_{12}x_1x_2$. Derive an expression for the odds ratio for the regressor x_1 . Does this have the same interpretation as in the case where the linear predictor does **not** have the interaction term?
- 13.22** The theory of maximum-likelihood states that the estimated large-sample covariance for maximum-likelihood estimates is the inverse of the **information matrix**, where the elements of the information matrix are the negatives of the expected values of the second partial derivatives of the log-likelihood function evaluated at the maximum-likelihood estimates. Consider the linear regression model with normal errors. Find the information matrix and the covariance matrix of the maximum-likelihood estimates.
- 13.23** Consider the automobile purchase data in Problem 13.5. Fit models using both the probit and complementary log-log functions. Compare three models to the one obtained using the logit.
- 13.24** Reconsider the pneumoconiosis data in Table 13.1. Fit models using both the probit and complimentary log-log functions. Compare these models to the one obtained in Example 13.1 using the logit.
- 13.25** On 28 January 1986 the space shuttle Challenger was destroyed in an explosion shortly after launch from Cape Kennedy. The cause of the explosion was eventually identified as catastrophic failure of the O-rings on the solid rocket booster. The failure likely occurred because the O-ring material was subjected to a lower temperature at launch (31°F) than was appropriate. The material and the solid rocket joints had never been tested at temperatures this low. Some O-ring failures had occurred during other shuttle launches (or engine static tests). The failure data observed prior to the Challenger launch is shown in the following table.

Temperature at Launch	At Least One O-ring Failure	Temperature at Launch	At Least One O-ring Failure
53	1	70	1
56	1	70	1
57	1	72	0
63	0	73	0
66	0	75	0
67	0	75	1
67	0	76	0
67	0	76	0
68	0	78	0
69	0	79	0
70	0	80	0
70	1	81	0

- a. Fit a logistic regression model to these data. Construct a graph of the data and display the fitted model. Discuss how well the model fits the data.
- b. Calculate and interpret the odds ratio.
- c. What is the estimated failure probability at 50°F?
- d. What is the estimated failure probability at 75°F?
- e. What is the estimated failure probability at 31°F? Notice that there is extrapolation involved in obtaining this estimate. What influence would that have on your recommendation about launching the space shuttle?
- f. Calculate and analyze the deviance residuals for this model.
- g. Add a quadratic term in temperature to the logistic regression model in part a. Is there any evidence that this term improves the model?

13.26 A student conducted a project looking at the impact of popping temperature, amount of oil, and the popping time on the number of inedible kernels of popcorn. The data follow. Analyze these data using Poisson regression.

Temperature	Oil	Time	y
7	4	90	24
5	3	105	28
7	3	105	40
7	2	90	42
6	4	105	11
6	3	90	16
5	3	75	126
6	2	105	34
5	4	90	32
6	2	75	32
5	2	90	34
7	3	75	17
6	3	90	30
6	3	90	17
6	4	75	50

13.27 Bailer and Piegorsch [2000] report on an experiment that examines the effect of a herbicide, nitrofen, on the number of offspring produced by a particular freshwater invertebrate zooplankton. The data follow. Perform an appropriate analysis of these data.

Dose	Number of Offspring									
Control	27	32	34	33	36	34	33	30	24	31
80	33	33	35	33	36	26	27	31	32	29
160	29	29	23	27	30	31	30	26	29	29
235	23	21	7	12	27	16	13	15	21	17
310	6	6	7	0	15	5	6	4	6	5

13.28 Chapman [1997–98] conducted an experiment using accelerated life testing to determine the estimated shelf life of a photographic developer. The data follow. Lifetimes often follow an exponential distribution. This company has found that the maximum density is a good indicator of overall developer/film performance; correspondingly using generalized linear models. Perform appropriate residual analysis of your final model.

t (h)	D_{\max} (72°C)	t (h)	D_{\max} (82°C)	t (h)	D_{\max} (92°C)
72	3.55	48	3.52	24	3.46
144	3.27	96	3.35	48	2.91
216	2.89	144	2.50	72	2.27
288	2.55	192	2.10	96	1.49
360	2.34	240	1.90	120	1.20
432	2.14	288	1.47	144	1.04
504	1.77	336	1.19	168	0.65

13.29 Gupta and Das [2000] performed an experiment to improve the resistivity of a urea formaldehyde resin. The factors were amount of sodium hydroxide, A , reflux time, B , solvent distillate, C , phthalic anhydride, D , water collection time, E , and solvent distillate collection time, F . The data follow, where y_1 is the resistivity from the first replicate of the experiment and y_2 is the resistivity from the second replicate. Assume a gamma distribution. Use both the canonical and the log link to analyze these data. Perform appropriate residual analysis of your final models.

A	B	C	D	E	F	y_1	y_2
-1	-1	-1	-1	-1	-1	60	135
-1	-1	-1	1	-1	-1	220	160
0	-1	-1	-1	1	1	85	180
0	-1	-1	1	1	1	330	110
0	1	1	1	-1	-1	95	130
0	1	1	-1	-1	-1	190	175
-1	1	1	1	1	1	145	200
-1	1	1	-1	1	1	300	210
1	-1	1	1	-1	1	110	100

<i>A</i>	<i>B</i>	<i>C</i>	<i>D</i>	<i>E</i>	<i>F</i>	y_1	y_2
1	-1	1	-1	-1	1	125	130
1	-1	1	1	1	-1	300	170
1	-1	1	-1	1	-1	65	160
1	1	-1	-1	-1	1	170	90
1	1	-1	1	-1	1	70	250
1	1	-1	-1	1	-1	380	80
1	1	-1	1	1	-1	105	200

CHAPTER 14

REGRESSION ANALYSIS OF TIME SERIES DATA

14.1 INTRODUCTION TO REGRESSION MODELS FOR TIME SERIES DATA

Many applications of regression involve both predictor and response variables that are **time series**, that is, the variables are time-oriented. Regression models using time series data occur relatively often in economics, business, and many fields of engineering. The assumption of uncorrelated or independent errors that is typically made for regression data that is not time-dependent is usually not appropriate for time series data. Usually the errors in time series data exhibit some type of **autocorrelated** structure. By autocorrelation we mean that the errors are correlated with themselves at different time periods. We will give a formal definition shortly.

There are several **sources** of autocorrelation in time series regression data. In many cases, the cause of autocorrelation is the failure of the analyst to include one or more important predictor variables in the model. For example, suppose that we wish to regress the annual sales of a product in a particular region of the country against the annual advertising expenditures for that product. Now the growth in the population in that region over the period of time used in the study will also influence the product sales. Failure to include the population size may cause the errors in the model to be positively autocorrelated, because if the per-capita demand for the product is either constant or increasing with time, population size is positively correlated with product sales.

The presence of autocorrelation in the errors has several effects on the ordinary least-squares regression procedure. These are summarized as follows:

1. The ordinary least squares (OLS) regression coefficients are still unbiased, but they are no longer minimum-variance estimates. We know this from our study of generalized least squares in Section 5.5.
2. When the errors are positively autocorrelated, the residual mean square may seriously underestimate the error variance σ^2 . Consequently, the standard errors of the regression coefficients may be too small. As a result confidence and prediction intervals are shorter than they really should be, and tests of hypotheses on individual regression coefficients may be misleading in that they may indicate that one or more predictor variables contribute significantly to the model when they really do not. Generally, underestimating the error variance σ^2 gives the analyst a false impression of precision of estimation and potential forecast accuracy.
3. The confidence intervals, prediction intervals, and tests of hypotheses based on the t and F distributions are, strictly speaking, no longer exact procedures.

There are three approaches to dealing with the problem of autocorrelation. If autocorrelation is present because of one or more omitted predictors and if those predictor variable(s) can be identified and included in the model, the observed autocorrelation should disappear. Alternatively, the weighted least squares or generalized least squares methods discussed in Section 5.5 could be used if there were sufficient knowledge of the autocorrelation structure. Finally, if these approaches cannot be used, then the analyst must turn to a model that specifically incorporates the autocorrelation structure. These models usually require special parameter estimation techniques. We will provide an introduction to these procedures in Section 14.3.

14.2 DETECTING AUTOCORRELATION: THE DURBIN–WATSON TEST

Residual plots can be useful for the detection of autocorrelation. The most useful display is the plot of residuals versus time. If there is positive autocorrelation, residuals of identical sign occur in clusters. That is, there are not enough changes of sign in the pattern of residuals. On the other hand, if there is negative autocorrelation, the residuals will alternate signs too rapidly.

Various **statistical tests** can be used to detect the presence of autocorrelation. The test developed by Durbin and Watson (1950, 1951, 1971) is a very widely used procedure. This test is based on the assumption that the errors in the regression model are generated by a **first-order autoregressive process** observed at equally spaced time periods, that is,

$$\varepsilon_t = \phi\varepsilon_{t-1} + a_t \quad (14.1)$$

where ε_t is the error term in the model at time period t , a_t is an NID $(0, \sigma_a^2)$ random variable, ϕ is a parameter that defines the relationship between successive values of the model errors ε_t and ε_{t-1} , and the time index is $t = 1, 2, \dots, T$ (T is the number of observations available, and it usually stands for the current time period). We will require that $|\phi| < 1$, so that the model error term in time period t is equal to a

fraction of the error experienced the immediately preceding period plus a normally and independently distributed random shock or disturbance that is unique to the current period. In time series regression models ϕ is sometimes called the **autocorrelation parameter**. Thus, a simple linear regression model with **first-order autoregressive errors** would be

$$y_t = \beta_0 + \beta_1 x_t + \varepsilon_t, \quad \varepsilon_t = \phi \varepsilon_{t-1} + a_t \quad (14.2)$$

where y_t and x_t are the observations on the response and predictor variables at time period t .

When the regression model errors are generated by the first-order autoregressive process in Eq. (14.1), there are several interesting properties of these errors. By successively substituting for $\varepsilon_t, \varepsilon_{t-1}, \dots$ on the right-hand side of Eq. (14.1) we obtain

$$\varepsilon_t = \sum_{j=0}^{\infty} \phi^j a_{t-j}$$

In other words, the error term in the regression model for period t is just a linear combination of all of the current and previous realizations of the NID $(0, \sigma^2)$ random variables a_t . Furthermore, we can show that

$$\begin{aligned} E(\varepsilon_t) &= 0 \\ V(\varepsilon_t) &= \sigma^2 = \sigma_a^2 \left(\frac{1}{1-\phi^2} \right) \\ \text{Cov}(\varepsilon_t, \varepsilon_{t \pm j}) &= \phi^j \sigma_a^2 \left(\frac{1}{1-\phi^2} \right) \end{aligned} \quad (14.3)$$

That is, the errors have zero mean and constant variance but have a nonzero covariance structure unless $\phi = 0$.

The **autocorrelation** between two errors that are one period apart, or the **lag one autocorrelation**, is

$$\begin{aligned} \rho_1 &= \frac{\text{Cov}(\varepsilon_t, \varepsilon_{t+1})}{\sqrt{V(\varepsilon_t)} \sqrt{V(\varepsilon_{t+1})}} \\ &= \frac{\phi \sigma_a^2 \left(\frac{1}{1-\phi^2} \right)}{\sqrt{\sigma_a^2 \left(\frac{1}{1-\phi^2} \right)} \sqrt{\sigma_a^2 \left(\frac{1}{1-\phi^2} \right)}} \\ &= \phi \end{aligned}$$

The autocorrelation between two errors that are k periods apart is

$$\rho_k = \phi^k, \quad i = 1, 2, \dots$$

This is called the **autocorrelation function**. Recall that we have required that $|\phi| < 1$. When ϕ is positive, all error terms are positively correlated, but the

magnitude of the correlation decreases as the errors grow further apart. Only if $\phi = 0$ are the model errors uncorrelated.

Most time series regression problems involve data with positive autocorrelation. The Durbin–Watson test is a statistical test for the presence of positive autocorrelation in regression model errors. Specifically, the hypotheses considered in the Durbin–Watson test are

$$\begin{aligned} H_0 : \phi &= 0 \\ H_1 : \phi &> 0 \end{aligned} \tag{14.4}$$

The Durbin–Watson **test statistic** is

$$d = \frac{\sum_{t=2}^T (e_t - e_{t-1})^2}{\sum_{t=1}^T e_t^2} = \frac{\sum_{t=2}^T e_t^2 + \sum_{t=2}^T e_{t-1}^2 - 2 \sum_{t=2}^T e_t e_{t-1}}{\sum_{t=1}^T e_t^2} \approx 2(1 - r_1) \tag{14.5}$$

where the $e_t, t = 1, 2, \dots, T$ are the residuals from an OLS regression of y_t on x_t , and r_1 is the **lag one sample autocorrelation coefficient** defined as

$$r_1 = \frac{\sum_{t=1}^{T-1} e_t e_{t+1}}{\sum_{t=1}^T e_t^2} \tag{14.6}$$

For uncorrelated errors $r_1 = 0$ (at least approximately) so the value of the Durbin–Watson statistic should be approximately 2. Statistical testing is necessary to determine just how far away from 2 the statistic must fall in order for us to conclude that the assumption of uncorrelated errors is violated. Unfortunately, the distribution of the Durbin–Watson test statistic d depends on the \mathbf{X} matrix, and this makes critical values for a statistical test difficult to obtain. However, Durbin and Watson (1951) show that d lies between lower and upper bounds, say d_L and d_U , such that if d is outside these limits, a conclusion regarding the hypotheses in Eq. (14.4) can be reached. The decision procedure is as follows:

- If $d < d_L$ reject $H_0 : \rho = 0$
- If $d > d_U$ do not reject $H_0 : \rho = 0$
- If $d_L \leq d \leq d_U$ the test is inconclusive

Table A.6 gives the bounds d_L and d_U for a range of sample sizes, various numbers of predictors, and three type I error rates ($\alpha = 0.05, \alpha = 0.025,$ and $\alpha = 0.01$). It is clear that small values of the test statistic d imply that $H_0 : \phi = 0$ should be rejected because positive autocorrelation indicates that successive error terms are of similar magnitude, and the differences in the residuals $e_t - e_{t-1}$ will be small. Durbin and

Watson suggest several procedures for resolving inconclusive results. A reasonable approach in many of these inconclusive situations is to analyze the data as if there were positive autocorrelation present to see if any major changes in the results occur.

Situations where negative autocorrelation occurs are not often encountered. However, if a test for negative autocorrelation is desired, one can use the statistic $4 - d$, where d is defined in Eq. (14.4). Then the decision rules for testing the hypotheses $H_0 : \phi = 0$ versus $H_1 : \phi < 0$ are the same as those used in testing for positive autocorrelation. It is also possible to test a two-sided alternative hypothesis ($H_0 : \phi = 0$ versus $H_1 : \phi \neq 0$) by using both of the one-sided tests simultaneously. If this is done, the two-sided procedure has type I error 2α , where α is the type I error used for each individual one-sided test.

Example 14.1

A company wants to use a regression model to relate annual regional advertising expenses to annual regional concentrate sales for a soft drink company. Table 14.1 presents 20 years of these data. We will initially assume that a straight-line relationship is appropriate and fit a simple linear regression model by ordinary least squares. The Minitab output for this model is shown in Table 14.2 and the residuals are shown in the last column of Table 14.1. Because these are time series data, there is a possibility that autocorrelation may be present. The plot of residuals versus time, shown in Figure 14.1, has a pattern indicative of potential autocorrelation; there is a definite upward trend in the plot, followed by a downward trend.

TABLE 14.1 Soft Drink Concentrate Sales Data

Year	Sales (Units)	Expenditures (1,000 of dollars)	Residuals
1	3083	75	-32.3298
2	3149	78	-26.6027
3	3218	80	2.2154
4	3239	82	-16.9665
5	3295	84	-1.1484
6	3374	88	-2.5123
7	3475	93	-1.9671
8	3569	97	11.6691
9	3597	99	-0.5128
10	3725	104	27.0324
11	3794	109	-4.4224
12	3959	115	40.0318
13	4043	120	23.5770
14	4194	127	33.9403
15	4318	135	-2.7874
16	4493	144	-8.6060
17	4683	153	0.5753
18	4850	161	6.8476
19	5005	170	-18.9710
20	5236	182	-29.0625

TABLE 14.2 Minitab Output for the Soft Drink Concentrate Sales Data

Regression Analysis: Sales versus Expenditures

The regression equation is

$$\text{Sales} = 1609 + 20.1 \text{ Expenditures}$$

Predictor	Coef	SE Coef	T	P
Constant	1608.51	17.02	94.49	0.000
Expenditures	20.0910	0.1428	140.71	0.00

S = 20.5316 R-Sq = 99.9% R-Sq(adj) = 99.9%

Analysis of Variance

Source	DF	SS	MS	F	P
Regression	1	8346283	8346283	19799.11	0.000
Residual Error	18	7588	422		
Total	19	8353871			

Unusual Observations

Obs	Expenditures	Sales	Fit	SE Fit	Residual	St Resid
12	115	3959.00	3918.97	4.59	40.03	2.00R

R denotes an observation with a large standardized residual.

Durbin-Watson statistic = 1.08005

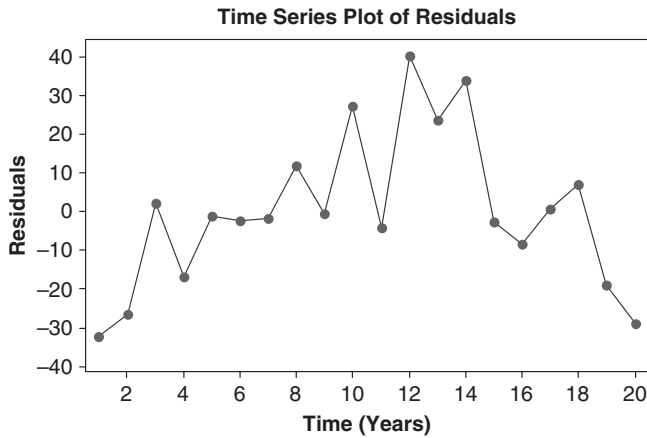

Figure 14.1 Plot of residuals versus time for the soft drink concentrate sales model.

We will use the Durbin–Watson test for

$$H_0 : \phi = 0$$

$$H_1 : \phi > 0$$

The test statistic is calculated as follows:

$$\begin{aligned}
 d &= \frac{\sum_{t=2}^{20} (e_t - e_{t-1})^2}{\sum_{t=1}^{20} e_t^2} \\
 &= \frac{[-26.6027 - (-32.3298)]^2 + [2.2154 - (-26.6027)]^2 + \cdots + [-29.0625 - (-18.9710)]^2}{(-32.3298)^2 + (-26.6027)^2 + \cdots + (-29.0625)^2} \\
 &= 1.08
 \end{aligned}$$

Minitab will also calculate and display the Durbin–Watson statistic. Refer to the Minitab output in Table 14.2. If we use a significance level of 0.05, Table A.6 gives the critical values corresponding to one predictor variable and 20 observations as $d_L = 1.20$ and $d_U = 1.41$. Since the calculated value of the Durbin–Watson statistic $d = 1.08$ is less than $d_L = 1.20$, we reject the null hypothesis and conclude that the errors in the regression model are positively autocorrelated. ■

14.3 ESTIMATING THE PARAMETERS IN TIME SERIES REGRESSION MODELS

A significant value of the Durbin–Watson statistic or a suspicious residual plot indicates a potential problem with autocorrelated model errors. This could be the result of an actual time dependence in the errors or an “artificial” time dependence caused by the omission of one or more important predictor variables. If the apparent autocorrelation results from missing predictors and if these missing predictors can be identified and incorporated into the model, the apparent autocorrelation problem may be eliminated. This is illustrated in the following example.

Example 14.2

Table 14.3 presents an expanded set of data for the soft drink concentrate sales problem introduced in Example 14.1. Because it is reasonably likely that regional population affects soft drink sales, we have provided data on regional population for each of the study years. Table 14.4 is the Minitab output for a regression model that includes both predictor variables, advertising expenditures and population. Both of these predictor variables are highly significant. The last column of Table 14.3 shows the residuals from this model. Minitab calculates the Durbin–Watson statistic for this model as $d = 3.05932$, and the 5% critical values are $d_L = 1.10$ and $d_U = 1.54$, and since d is greater than d_U , we conclude that there is no evidence to reject the null hypothesis. That is, there is no indication of autocorrelation in the errors.

Figure 14.2 is a plot of the residuals from this regression model in time order. This plot shows considerable improvement when compared to the plot of residuals from the model using only advertising expenditures as the predictor. Therefore, we conclude that adding the new predictor population size to the original model has eliminated an apparent problem with autocorrelation in the errors. ■

TABLE 14.3 Expanded Soft Drink Concentrate Sales Data for Example 14.2

Year	Sales (Units)	Expenditures (1,000 of dollars)	Population	Residuals
1	3083	75	825000	-4.8290
2	3149	78	830445	-3.2721
3	3218	80	838750	14.9179
4	3239	82	842940	-7.9842
5	3295	84	846315	5.4817
6	3374	88	852240	0.7986
7	3475	93	860760	-4.6749
8	3569	97	865925	6.9178
9	3597	99	871640	-11.5443
10	3725	104	877745	14.0362
11	3794	109	886520	-23.8654
12	3959	115	894500	17.1334
13	4043	120	900400	-0.9420
14	4194	127	904005	14.9669
15	4318	135	908525	-16.0945
16	4493	144	912160	-13.1044
17	4683	153	917630	1.8053
18	4850	161	922220	13.6264
19	5005	170	925910	-3.4759
20	5236	182	929610	0.1025

TABLE 14.4 Minitab Output for the Soft Drink Concentrate Data in Example 14.2

Regression Analysis: Sales versus Expenditures, Population

The regression equation is

$$\text{Sales} = 320 + 18.4 \text{ Expenditures} + 0.00168 \text{ Population}$$

Predictor	Coef	SE Coef	T	P
Constant	320.3	217.3	1.47	0.159
Expenditures	18.4342	0.2915	63.23	0.000
Population	0.0016787	0.0002829	5.93	0.000

S = 12.0557 R-Sq = 100.0% R-Sq(adj) = 100.0%

Analysis of Variance

Source	DF	SS	MS	F	P
Regression	2	8351400	4175700	28730.40	0.000
Residual Error	17	2471	145		
Total	19	8353871			

Source	DF	Seq SS
Expenditures	1	8346283
Population	1	5117

Unusual Observations

Obs	Expenditures	Sales	Fit	SE Fit	Residual	St Resid
11	109	3794.00	3817.87	4.27	-23.87	-2.12R

R denotes an observation with a large standardized residual.

Durbin-Watson statistic = 3.05932

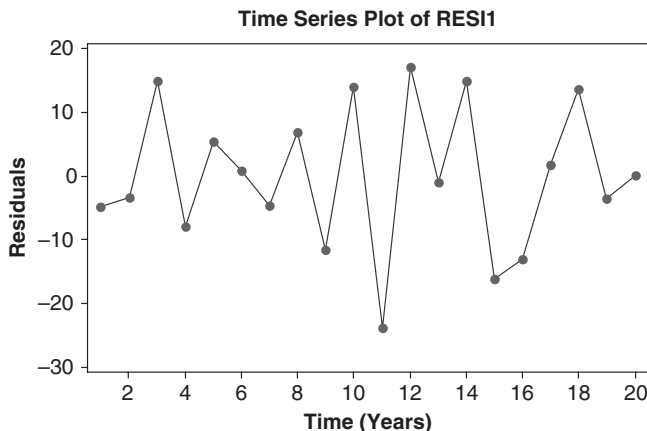

Figure 14.2 Plot of residuals versus time for the soft drink concentrate sales model in example 14.2.

The Cochrane–Orcutt Method When the observed autocorrelation in the model errors cannot be removed by adding one or more new predictor variables to the model, it is necessary to take explicit account of the autocorrelative structure in the model and use an appropriate parameter estimation method. A very good and widely used approach is the procedure devised by Cochrane and Orcutt (1949).

We now describe the Cochrane–Orcutt method for the simple linear regression model with first-order autocorrelated errors given in Eq. (14.2). The procedure is based on transforming the response variable so that $y'_t = y_t - \phi y_{t-1}$. Substituting for y_t and y_{t-1} , the model becomes

$$\begin{aligned}
 y'_t &= y_t - \phi y_{t-1} \\
 &= \beta_0 + \beta_1 x_t + \varepsilon_t - \phi(\beta_0 + \beta_1 x_{t-1} + \varepsilon_{t-1}) \\
 &= \beta_0(1 - \phi) + \beta_1(x_t - \phi x_{t-1}) + \varepsilon_t - \phi \varepsilon_{t-1} \\
 &= \beta'_0 + \beta_1 x'_t + \varepsilon_t
 \end{aligned}
 \tag{14.7}$$

where $\beta'_0 = \beta_0(1 - \phi)$ and $x'_t = x_t - \phi x_{t-1}$. Notice that the error terms a_t in the transformed or reparameterized model are independent random variables. Unfortunately, this new reparameterized model contains an unknown parameter ϕ and it is also no longer linear in the unknown parameters because it involves products of ϕ , β_0 , and β_1 . However, the first-order autoregressive process $\varepsilon_t = \phi \varepsilon_{t-1} + a_t$ can be viewed as a simple linear regression through the origin and the parameter ϕ can be estimated by obtaining the residuals of an OLS regression of y_t on x_t and then regressing e_t on e_{t-1} . The OLS regression of e_t on e_{t-1} results in

$$\hat{\phi} = \frac{\sum_{t=2}^T e_t e_{t-1}}{\sum_{t=1}^T e_t^2}
 \tag{14.8}$$

Using $\hat{\phi}$ as an estimate of ϕ , we can calculate the transformed response and predictor variables as

$$y'_t = y_t - \hat{\phi}y_{t-1}$$

$$x'_t = x_t - \hat{\phi}x_{t-1}$$

Now apply ordinary least squares to the transformed data. This will result in estimates of the transformed slope $\hat{\beta}'_0$, the intercept $\hat{\beta}'_1$, and a new set of residuals. The Durbin–Watson test can be applied to these new residuals from the reparametrized model. If this test indicates that the new residuals are uncorrelated, then no additional analysis is required. However, if positive autocorrelation is still indicated, then another iteration is necessary. In the second iteration ϕ is estimated with new residuals that are obtained by using the regression coefficients from the reparametrized model with the original regressor and response variables. This iterative procedure may be continued as necessary until the residuals indicate that the error terms in the reparametrized model are uncorrelated. Usually only one or two iterations are sufficient to produce uncorrelated errors.

Example 14.3

Table 14.5 presents data on the market share of a particular brand of toothpaste for 30 time periods and the corresponding selling price per pound. A simple linear regression model is fit to these data, and the resulting Minitab output is in Table 14.6. The residuals from this model are shown in Table 14.5. The Durbin–Watson

TABLE 14.5 Toothpaste Market Share Data

Time	Market Share	Price	Residuals	y'_t	x'_t	Residuals
1	3.63	0.97	0.281193			
2	4.20	0.95	0.365398	2.715	0.533	-0.189435
3	3.33	0.99	0.466989	1.612	0.601	0.392201
4	4.54	0.91	-0.266193	3.178	0.505	-0.420108
5	2.89	0.98	-0.215909	1.033	0.608	-0.013381
6	4.87	0.90	-0.179091	3.688	0.499	-0.058753
7	4.90	0.89	-0.391989	2.908	0.522	-0.268949
8	5.29	0.86	-0.730682	3.286	0.496	-0.535075
9	6.18	0.85	-0.083580	4.016	0.498	0.244473
10	7.20	0.82	0.207727	4.672	0.472	0.256348
11	7.25	0.79	-0.470966	4.305	0.455	-0.531811
12	6.09	0.83	-0.659375	3.125	0.507	-0.423560
13	6.80	0.81	-0.435170	4.309	0.471	-0.131426
14	8.65	0.77	0.443239	5.869	0.439	0.635804
15	8.43	0.76	-0.019659	4.892	0.445	-0.192552
16	8.29	0.80	0.811932	4.842	0.489	0.847507
17	7.18	0.83	0.430625	3.789	0.503	0.141344
18	7.90	0.79	0.179034	4.963	0.451	0.027093
19	8.45	0.76	0.000341	5.219	0.437	-0.063744
20	8.23	0.78	0.266136	4.774	0.469	0.284026

TABLE 14.6 Minitab Regression Results for the Toothpaste Market Share Data**Regression Analysis: Market Share versus Price**

The regression equation is

$$\text{Market Share} = 26.9 - 24.3 \text{ Price}$$

Predictor	Coef	SE Coef	T	P
Constant	26.910	1.110	24.25	0.000
Price	-24.290	1.298	-18.72	0.000

S = 0.428710 R-Sq = 95.1% R-Sq(adj) = 94.8%

Analysis of Variance

Source	DF	SS	MS	F	P
Regression	1	64.380	64.380	350.29	0.000
Residual Error	18	3.308	0.184		
Total	19	67.688			

Durbin-Watson statistic = 1.13582

TABLE 14.7 Minitab Regression Results for Fitting the Transformed Model to the Toothpaste Sales Data**Regression Analysis: y-prime versus x-prime**

The regression equation is

$$y\text{-prime} = 16.1 - 24.8 x\text{-prime}$$

Predictor	Coef	SE Coef	T	P
Constant	16.1090	0.9610	16.76	0.000
x-prime	-24.774	1.934	-12.81	0.000

S = 0.390963 R-Sq = 90.6% R-Sq(adj) = 90.1%

Analysis of Variance

Source	DF	SS	MS	F	P
Regression	1	25.080	25.080	164.08	0.000
Residual Error	17	2.598	0.153		
Total	18	27.679			

Unusual Observations

Obs	x-prime	y-prime	Fit	SE Fit	Residual	St Resid
2	0.601	1.6120	1.2198	0.2242	0.3922	1.22 X
4	0.608	1.0330	1.0464	0.2367	-0.0134	-0.04 X
15	0.489	4.8420	3.9945	0.0904	0.8475	2.23R

R denotes an observation with a large standardized residual.

X denotes an observation whose X value gives it large influence.

Durbin-Watson statistic = 2.15671

statistic for the residuals from this model is $d = 1.13582$ (see the Minitab output), and the 5% critical values are $d_L = 1.20$ and $d_U = 1.41$, so there is evidence to support the conclusion that the residuals are positively autocorrelated.

We use the Cochran–Orcutt method to estimate the model parameters. The autocorrelation coefficient can be estimated using the residuals in Table 14.7 and Eq. (14.8) as follows:

$$\begin{aligned}\hat{\phi} &= \frac{\sum_{t=2}^T e_t e_{t-1}}{\sum_{y=1}^T e_y^2} \\ &= \frac{1.3547}{3.3083} \\ &= 0.409\end{aligned}$$

The transformed variables are computed according to

$$\begin{aligned}y'_t &= y_t - 0.409y_{t-1} \\ x'_t &= x_t - 0.409x_{t-1}\end{aligned}$$

for $t = 2, 3, \dots, 20$. These transformed variables are also shown in Table 14.5. The Minitab results for fitting a regression model to the transformed data are summarized in Table 14.7. The residuals from the transformed model are shown in the last column of Table 14.5. The Durbin–Watson statistic for the transformed model is $d = 2.15671$, and the 5% critical values from Table A.6 are $d_L = 1.18$ and $d_U = 1.40$, so we conclude that there is no problem with autocorrelated errors in the transformed model. The Cochrane–Orcutt method has been effective in removing the autocorrelation.

The slope in the transformed model β'_1 is equal to the slope in the original model, β_1 . A comparison of the slopes in the two models in Tables 14.6 and 14.7 shows that the two estimates are very similar. However, if the standard errors are compared, the Cochrane–Orcutt method produces an estimate of the slope that has a larger standard error than the standard error of the ordinary least squares estimate. This reflects the fact that if the errors are autocorrelated and OLS is used, the standard errors of the model coefficients are likely to be underestimated. ■

The Maximum Likelihood Approach There are other alternatives to the Cochrane–Orcutt method. A popular approach is to use the method of **maximum likelihood** to estimate the parameters in a time-series regression model. We will concentrate on the simple linear regression model with first-order autoregressive errors

$$y_t = \beta_0 + \beta_1 x_t + \varepsilon_t, \quad \varepsilon_t = \phi \varepsilon_{t-1} + a_t \quad (14.9)$$

One reason that the method of maximum likelihood is so attractive is that, unlike the Cochrane–Orcutt method, it can be used in situations where the autocorrelative structure of the errors is more complicated than first-order autoregressive.

Recall that the a 's in Eq. (14.9) are normally and independently distributed with mean zero and variance σ_a^2 and ϕ is the autocorrelation parameter. Write this equation for y_{t-1} and subtract ϕy_{t-1} from y_t . This results in

$$y_t - \phi y_{t-1} = (1 - \phi)\beta_0 + \beta_1(x_t - \phi x_{t-1}) + a_t$$

or

$$\begin{aligned} y_t &= \phi y_{t-1} + (1-\phi)\beta_0 + \beta_1(x_t - \phi x_{t-1}) + a_t \\ &= \mu(\mathbf{z}_t, \boldsymbol{\theta}) + a_t \end{aligned} \quad (14.10)$$

where $\mathbf{z}'_t = [y_{t-1}, x_t]$ and $\boldsymbol{\theta}' = [\phi, \beta_0, \beta_1]$. We can think of \mathbf{z}_t as a vector of predictor variables and $\boldsymbol{\theta}$ as the vector of regression model parameters. Since y_{t-1} appears on the right-hand side of the model in Eq. (14.10), the index of time must run from 2, 3, . . . , T . At time period $t = 2$, we treat y_1 as an observed predictor.

Because the a 's are normally and independently distributed, the joint probability density of the a 's is

$$\begin{aligned} f(a_2, a_3, \dots, a_T) &= \prod_{t=2}^T \frac{1}{\sigma_a \sqrt{2\pi}} e^{-\frac{1}{2} \left(\frac{a_t}{\sigma_a}\right)^2} \\ &= \left(\frac{1}{\sigma_a \sqrt{2\pi}}\right)^{T-1} \exp\left(-\frac{1}{2\sigma_a^2} \sum_{t=1}^T a_t^2\right) \end{aligned}$$

and the likelihood function is obtained from this joint distribution by substituting for the a 's:

$$l(y_t, \phi, \beta_0, \beta_1) = \left(\frac{1}{\sigma_a \sqrt{2\pi}}\right)^{T-1} \exp\left(-\frac{1}{2\sigma_a^2} \sum_{t=2}^T \{y_t - [\phi y_{t-1} + (1-\phi)\beta_0 + \beta_1(x_t - \phi x_{t-1})]\}^2\right)$$

The log-likelihood is

$$\begin{aligned} \ln l(y_t, \phi, \beta_0, \beta_1) &= \\ &= -\frac{T-1}{2} \ln(2\pi) - (T-1) \ln \sigma_a - \frac{1}{2\sigma_a^2} \sum_{t=2}^T \{y_t - [\phi y_{t-1} + (1-\phi)\beta_0 + \beta_1(x_t - \phi x_{t-1})]\}^2 \end{aligned}$$

This log-likelihood is maximized with respect to the parameters ϕ , β_0 , and β_1 by minimizing the quantity

$$SS_E = \sum_{t=2}^T \{y_t - [\phi y_{t-1} + (1-\phi)\beta_0 + \beta_1(x_t - \phi x_{t-1})]\}^2 \quad (14.11)$$

which is the error sum of squares for the model. Therefore, the maximum likelihood estimators of ϕ , β_0 , and β_1 are also least squares estimators.

There are two important points about the maximum likelihood (or least squares) estimators. First, the sum of squares in Eq. (14.11) is conditional on the initial value of the time series, y_1 . Therefore, the maximum likelihood (or least squares) estimators found by minimizing this conditional sum of squares are conditional maximum likelihood (or conditional least squares) estimators. Second, because the model involves products of the parameters ϕ and β_0 , the model is no longer linear in the unknown parameters. That is, it is not a linear regression model and consequently we cannot give an explicit closed-form solution for the parameter estimators.

Iterative methods for fitting nonlinear regression models must be used. From Chapter 12, we know that these procedures work by linearizing the model about a set of initial guesses for the parameters, solving the linearized model to obtain improved parameters estimates, then using the improved estimates to define a new linearized model which leads to new parameter estimates, and so on.

Suppose that we have obtained a set of parameter estimates, say $\hat{\boldsymbol{\theta}}' = [\hat{\phi}, \hat{\beta}_0, \hat{\beta}_1]$. The maximum likelihood estimate of σ_a^2 is computed as

$$\hat{\sigma}_a^2 = \frac{SS_E(\hat{\boldsymbol{\theta}})}{n-1} \quad (14.12)$$

where $SS_E(\hat{\boldsymbol{\theta}})$ is the error sum of squares in Eq. (14.11) evaluated at the conditional maximum likelihood (or conditional least squares) parameters estimates $\hat{\boldsymbol{\theta}}' = [\hat{\phi}, \hat{\beta}_0, \hat{\beta}_1]$. Some authors (and computer programs) use an adjusted number of degrees of freedom in the denominator to account for the number of parameters that have been estimated. If there are k predictors, then the number of estimated parameters will be $p = k + 3$, and the formula for estimating σ_a^2 is

$$\hat{\sigma}_a^2 = \frac{SS_E(\hat{\boldsymbol{\theta}})}{n-p-1} = \frac{SS_E(\hat{\boldsymbol{\theta}})}{n-k-4} \quad (14.13)$$

In order to test hypotheses about the model parameters and to find confidence intervals, standard errors of the model parameters are needed. The standard errors are usually found by expanding the nonlinear model in a first-order Taylor series around the final estimates of the parameters $\hat{\boldsymbol{\theta}}' = [\hat{\phi}, \hat{\beta}_0, \hat{\beta}_1]$. This results in

$$y_t \approx \mu(\mathbf{z}_t, \hat{\boldsymbol{\theta}}) + (\boldsymbol{\theta} - \hat{\boldsymbol{\theta}})' \left. \frac{\partial \mu(\mathbf{z}_t, \boldsymbol{\theta})}{\partial \boldsymbol{\theta}} \right|_{\boldsymbol{\theta}=\hat{\boldsymbol{\theta}}} + a_t$$

The column vector of derivatives, $\frac{\partial \mu(\mathbf{z}_t, \boldsymbol{\theta})}{\partial \boldsymbol{\theta}}$, is found by differentiating the model with respect to each parameter in the vector $\boldsymbol{\theta}' = [\phi, \beta_0, \beta_1]$. This vector of derivatives is

$$\frac{\partial \mu(\mathbf{z}_t, \boldsymbol{\theta})}{\partial \boldsymbol{\theta}} = \begin{bmatrix} 1 - \phi \\ x_t - x_{t-1} \\ y_{t-1} - \beta_0 - \beta_1 x_{t-1} \end{bmatrix}$$

This vector is evaluated for each observation at the set of conditional maximum likelihood parameter estimates $\hat{\boldsymbol{\theta}}' = [\hat{\phi}, \hat{\beta}_0, \hat{\beta}_1]$ and assembled into an \mathbf{X} matrix. Then the covariance matrix of the parameter estimates is found from

$$Cov(\hat{\boldsymbol{\theta}}) = \sigma_a^2 (\mathbf{X}'\mathbf{X})^{-1}$$

When σ_a^2 is replaced by the estimate $\hat{\sigma}_a^2$ from Eq. (14.13) an estimate of the covariance matrix results, and the standard errors of the model parameters are the main diagonals of the covariance matrix.

Example 14.4

We will fit the regression model with time series errors in Eq. (14.9) to the toothpaste market share data originally analyzed in Example 14.3. Minitab will not fit these types of regression models, so we will use another widely available software package, SAS (the Statistical Analysis System). The SAS procedure for fitting regression models with time series errors is SAS PROC AUTOREG. Table 14.8 contains the output from this software program for the toothpaste market share data. Notice that the autocorrelation parameter (or the lag one autocorrelation) is estimated to be 0.4094, which is very similar to the value obtained by the Cochrane–Orcutt method. The overall R^2 for this model is 0.9601, and we can show that the residuals exhibit no autocorrelative structure, so this is likely a reasonable model for the data.

There is, of course, some possibility that a more complex autocorrelation structure that first-order may exist. SAS PROC AUTOREG can fit more complex patterns. Since there is obviously first-order autocorrelation present, an obvious possibility is that the autocorrelation might be second-order autoregressive, as in

$$\varepsilon_t = \phi_1 \varepsilon_{t-1} + \phi_2 \varepsilon_{t-2} + a_t$$

where the parameters ϕ_1 and ϕ_2 are autocorrelations at lags one and two, respectively. The output from SAS AUTOREG for this model is in Table 14.9. The t statistic for the lag two autocorrelation is not significant so there is no reason to believe that this more complex autocorrelative structure is necessary to adequately model the data. The model with first-order autoregressive errors is satisfactory. ■

Prediction of New Observations and Prediction Intervals We now consider how to obtain predictions of new observations. These are actually forecasts of future values at some **lead time**. It is very tempting to ignore the autocorrelation in the data when making predictions of future values (forecasting), and simply substitute the conditional maximum likelihood estimates into the regression equation:

$$\hat{y}_t = \hat{\beta}_0 + \hat{\beta}_1 x_t$$

Now, suppose that we are at the end of the current time period, T , and we wish to obtain a prediction or forecast for period $T + 1$. Using the above equation, this results in

$$\hat{y}_{T+1}(T) = \hat{\beta}_0 + \hat{\beta}_1 x_{T+1}$$

assuming that the value of the predictor variable in the next time period x_{T+1} is known. Unfortunately, this naive approach isn't correct. From Eq. (14.10), we know that the observation at time period t is

$$y_t = \phi y_{t-1} + (1 - \phi)\beta_0 + \beta_1(x_t - \phi x_{t-1}) + a_t \quad (14.14)$$

TABLE 14.8 SAS PROC AUTOREG Output for the Toothpaste Market Share Data, Assuming First-Order Autoregressive Errors

The SAS System
The AUTOREG Procedure
Dependent Variable y

Ordinary Least Squares Estimates

SSE	3.30825739	DFE	18
MSE	0.18379	Root MSE	0.42871
SBC	26.762792	AIC	24.7713275
Regress R-Square	0.9511	Total R-Square	0.9511
Durbin-Watson	1.1358	Pr < DW	0.0098
Pr > DW	0.9902		

NOTE: Pr<DW is the p-value for testing positive autocorrelation, and Pr>DW is the p-value for testing negative autocorrelation.

Standard Variable	DF	Approximate Estimate	Error	t Value	Pr > t	Variable Label
Intercept	1	26.9099	1.1099	24.25	<.0001	
x	1	-24.2898	1.2978	-18.72	<.0001	x

Estimates of Autocorrelations

Lag	Covariance	Correlation	-1	9	8	7	6	5	4	3	2	1	0	1	2	3	4	5
			6	7	8	9	1											
0	0.1654	1.000000												*****				
1	0.0677	0.409437												*****				

Preliminary MSE 0.1377

Estimates of Autoregressive Parameters

Standard Lag	Coefficient	Error	t Value
1	-0.409437	0.221275	-1.85

Algorithm converged.

The SAS System
The AUTOREG Procedure
Maximum Likelihood Estimates

SSE	2.69864377	DFE	17
MSE	0.15874	Root MSE	0.39843
SBC	25.8919447	AIC	22.9047479
Regress R-Square	0.9170	Total R-Square	0.9601
Durbin-Watson	1.8924	Pr < DW	0.3472
Pr > DW	0.6528		

NOTE: Pr<DW is the p-value for testing positive autocorrelation, and Pr>DW is the p-value for testing negative autocorrelation.

Standard Variable	DF	Approximate Estimate	Error	t Value	Pr > t	Variable Label
Intercept	1	26.3322	1.4777	17.82	<.0001	
x	1	-23.5903	1.7222	-13.70	<.0001	x
AR1	1	-0.4323	0.2203	-1.96	0.0663	

Autoregressive parameters assumed given.

Standard Variable	DF	Approximate Estimate	Error	t Value	Pr > t	Variable Label
Intercept	1	26.3322	1.4776	17.82	<.0001	
x	1	-23.5903	1.7218	-13.70	<.0001	x

TABLE 14.9 SAS PROC AUTOREG Output for the Toothpaste Market Share Data, Assuming Second-Order Autoregressive Errors

The SAS System
The AUTOREG Procedure
Dependent Variable y

Ordinary Least Squares Estimates

SSE	3.30825739	DFE	18
MSE	0.18379	Root MSE	0.42871
SBC	26.762792	AIC	24.7713275
Regress R-Square	0.9511	Total R-Square	0.9511
Durbin-Watson	1.1358	Pr < DW	0.0098
Pr > DW	0.9902		

NOTE: Pr<DW is the p-value for testing positive autocorrelation, and Pr>DW is the p-value for testing negative autocorrelation.

Standard Variable	DF	Approx Estimate	Variable Error	t Value	Pr > t	Label
Intercept	1	26.9099	1.1099	24.25	<.0001	
x	1	-24.2898	1.2978	-18.72	<.0001	x

Estimates of Autocorrelations

Lag	Covariance	Correlation	-1	9	8	7	6	5	4	3	2	1	0	1	2	3	4	5	6
			7	8	9	1													
0	0.1654	1.000000																	
1	0.0677	0.409437																	
2	0.0223	0.134686																	

Preliminary MSE 0.1375

Estimates of Autoregressive Parameters

Standard Lag	Coefficient	Error	t Value
1	-0.425646	0.249804	-1.70
2	0.039590	0.249804	0.16

Algorithm converged.

The SAS System
The AUTOREG Procedure
Maximum Likelihood Estimates

SSE	2.69583958	DFE	16
MSE	0.16849	Root MSE	0.41048
SBC	28.8691217	AIC	24.8861926
Regress R-Square	0.9191	Total R-Square	0.9602
Durbin-Watson	1.9168	Pr < DW	0.3732
Pr > DW	0.6268		

NOTE: Pr<DW is the p-value for testing positive autocorrelation, and Pr>DW is the p-value for testing negative autocorrelation.

Standard Variable	DF	Approx Estimate	Variable Error	t Value	Pr > t	Label
Intercept	1	26.3406	1.5493	17.00	<.0001	
x	1	-23.6025	1.8047	-13.08	<.0001	x
AR1	1	-0.4456	0.2562	-1.74	0.1012	
AR2	1	0.0297	0.2617	0.11	0.9110	

Autoregressive parameters assumed given.

Standard Variable	DF	Approx Estimate	Variable Error	t Value	Pr > t	Label
Intercept	1	26.3406	1.5016	17.54	<.0001	
x	1	-23.6025	1.7502	-13.49	<.0001	x

So at the end of the current time period T the next observation is

$$y_{T+1} = \phi y_T + (1 - \phi)\beta_0 + \beta_1(x_{T+1} - \phi x_T) + a_{T+1}$$

Assume that the future value of the regressor variable x_{T+1} is known. Obviously, at the end of the current time period, both y_T and x_T are known. The random error at time $T + 1$ a_{T+1} hasn't been observed yet, and because we have assumed that the expected value of the errors is zero, the best estimate we can make of a_{T+1} is $a_{T+1} = 0$. This suggests that a reasonable forecast of the observation in time period $T + 1$ that we can make the end of the current time period T is

$$\hat{y}_{T+1}(T) = \hat{\phi} y_T + (1 - \hat{\phi})\hat{\beta}_0 + \hat{\beta}_1(x_{T+1} - \hat{\phi} x_T) \quad (14.15)$$

Notice that this forecast is likely to be very different than the naïve forecast obtained by ignoring the autocorrelation.

To find a **prediction interval** on the forecast, we need to find the variance of the prediction error. The one-step-ahead forecast error is

$$y_{T+1} - \hat{y}_{T+1}(T) = a_{T+1}$$

assuming that all of the parameters in the forecasting model are known. The variance of the one-step ahead forecast error is

$$V(a_{T+1}) = \sigma_a^2$$

Using the variance of the one-step-ahead forecast error, we can construct a $100(1 - \alpha)\%$ prediction interval for the lead-one forecast from Eq. (14.15). The PI is

$$\hat{y}_{T+1}(T) \pm z_{\alpha/2} \sigma_a$$

where $z_{\alpha/2}$ is the upper $\alpha/2$ percentage point of the standard normal distribution. To actually compute an interval, we must replace σ_a by an estimate, resulting in

$$\hat{y}_{T+1}(T) \pm z_{\alpha/2} \hat{\sigma}_a \quad (14.16)$$

as the PI. Because σ_a and the model parameters in the forecasting equation been replaced by estimates, the probability level on the PI in Eq. (14.16) is only approximate.

Now suppose that we want to forecast two periods ahead assuming that we are at the end of the current time period, T . Using Eq. (14.14), we can write the observation at time period $T + 2$ as

$$\begin{aligned} y_{T+2} &= \phi y_{T+1} + (1 - \phi)\beta_0 + \beta_1(x_{T+2} - \phi x_{T+1}) + a_{T+2} \\ &= \phi[\phi y_T + (1 - \phi)\beta_0 + \beta_1(x_{T+1} - \phi x_T) + a_{T+1}] + (1 - \phi)\beta_0 + \beta_1(x_{T+2} - \phi x_{T+1}) + a_{T+2} \end{aligned}$$

Assume that the future value of the regressor variables x_{T+1} and x_{T+2} are known. At the end of the current time period, both y_T and x_T are known. The random errors

at time $T + 1$ and $T + 2$ haven't been observed yet, and because we have assumed that the expected value of the errors is zero, the best estimate we can make of both a_{T+1} and a_{T+2} is zero. This suggests that the forecast of the observation in time period $T + 2$ made at the end of the current time period T is

$$\begin{aligned}\hat{y}_{T+2}(T) &= \hat{\phi}[\hat{\phi}y_T + (1 - \hat{\phi})\hat{\beta}_0 + \hat{\beta}_1(x_{T+1} - \hat{\phi}x_T)] + (1 - \hat{\phi})\beta\phi_0 + \hat{\beta}_1(x_{T+2} - \hat{\phi}x_{T+1}) \\ &= \hat{\phi}\hat{y}_{T+1}(T) + (1 - \hat{\phi})\hat{\beta}_0 + \hat{\beta}_1(x_{T+2} - \hat{\phi}x_{T+1})\end{aligned}\quad (14.17)$$

The two-step-ahead forecast error is

$$y_{T+2} - \hat{y}_{T+2}(T) = a_{T+2} + \phi a_{T+1}$$

assuming that all estimated parameters are actually known. The variance of the two-step ahead forecast error is

$$\begin{aligned}V(a_{T+2} + \phi a_{T+1}) &= \sigma_a^2 + \phi^2 \sigma_a^2 \\ &= (1 + \phi^2) \sigma_a^2\end{aligned}$$

Using the variance of the two-step-ahead forecast error, we can construct a 100(1- α)% PI for the lead-one forecast from Eq. (14.15):

$$\hat{y}_{T+2}(T) \pm z_{\alpha/2}[(1 + \phi^2)]^{1/2} \sigma_a$$

To actually compute the PI, both σ_a and ϕ must be replaced by estimates, resulting in

$$\hat{y}_{T+2}(T) \pm z_{\alpha/2}[(1 + \hat{\phi}^2)]^{1/2} \hat{\sigma}_a \quad (14.18)$$

as the PI. Because σ_a and ϕ have been replaced by estimates, the probability level on the PI in Eq. (14.18) is only approximate.

In general, if we want to forecast τ periods ahead, the forecasting equation is

$$\hat{y}_{T+\tau}(T) = \hat{\phi}\hat{y}_{T+\tau-1}(T) + (1 - \hat{\phi})\hat{\beta}_0 + \hat{\beta}_1(x_{T+\tau} - \hat{\phi}x_{T+\tau-1}) \quad (14.19)$$

The τ -step-ahead forecast error is (assuming that the estimated model parameters are known)

$$y_{T+\tau} - \hat{y}_{T+\tau}(T) = a_{T+\tau} + \phi a_{T+\tau-1} + \dots + \phi^{\tau-1} a_{T+1}$$

and the variance of the τ -step-ahead forecast error is

$$\begin{aligned}V(a_{T+\tau} + \phi a_{T+\tau-1} + \dots + \phi^{\tau-1} a_{T+1}) &= (1 + \phi^2 + \dots + \phi^{2(\tau-1)}) \sigma_a^2 \\ &= \frac{1 - \phi^{2\tau}}{1 - \phi^2} \sigma_a^2\end{aligned}$$

A $100(1-\alpha)\%$ PI for the lead- τ forecast from Eq. (14.19) is

$$\hat{y}_{T+\tau}(T) \pm z_{\alpha/2} \left(\frac{1-\phi^{2\tau}}{1+\phi^2} \right)^{1/2} \sigma_a$$

Replacing σ_a and ϕ by estimates, the approximate $100(1-\alpha)\%$ PI is actually computed from

$$\hat{y}_{T+\tau}(T) \pm z_{\alpha/2} \left(\frac{1-\hat{\phi}^{2\tau}}{1+\hat{\phi}^2} \right)^{1/2} \hat{\sigma}_a \tag{14.20}$$

The Case Where the Predictor Variable Must Also Be Forecast In the preceding discussion, we assumed that in order to make forecasts, any necessary values of the predictor variable in future time periods $T + \tau$ are known. This is often (probably usually) an unrealistic assumption. For example, if you are trying to forecast how many new vehicles will be registered in the state of Arizona in some future year $T + \tau$ as a function of the state population in year $T + \tau$, it's pretty unlikely that you will actually know the state population in that future year.

A straightforward solution to this problem is to replace the required future values of the predictor variable in future time periods $T + \tau$ by forecasts of these values. For example, suppose that we are forecasting one period ahead. From Eq. (14.15) we know that the forecast for y_{T+1} is

$$\hat{y}_{T+1}(T) = \hat{\phi}y_T + (1-\hat{\phi})\hat{\beta}_0 + \hat{\beta}_1(x_{T+1} - \hat{\phi}x_T)$$

But the future value of x_{T+1} isn't known. Let $\hat{x}_{T+1}(T)$ be an unbiased forecast of x_{T+1} , made at the end of the current time period T . Now the forecast for y_{T+1} is

$$\hat{y}_{T+1}(T) = \hat{\phi}y_T + (1-\hat{\phi})\hat{\beta}_0 + \hat{\beta}_1[\hat{x}_{T+1}(T) - \hat{\phi}x_T] \tag{14.21}$$

If we assume that the model parameters are known, the one-step-ahead forecast error is

$$y_{T+1} - \hat{y}_{T+1}(T) = a_{T+1} + \beta_1[x_{T+1} - \hat{x}_{T+1}(T)]$$

and the variance of this forecast error is

$$V(a_{T+1}) = \sigma_a^2 + \beta_1^2 \sigma_x^2(1) \tag{14.22}$$

where $\sigma_x^2(1)$ is the variance of the one-step-ahead forecast error for the predictor variable x and we have assumed that the random error a_{T+1} in period $T + 1$ is independent of the error in forecasting the predictor variable. Using the variance of the one-step-ahead forecast error we can construct a $100(1-\alpha)\%$ prediction interval for the lead-one forecast from Eq. (14.21). The PI is

$$\hat{y}_{T+1}(T) \pm z_{\alpha/2} [\sigma_a^2 + \beta_1^2 \sigma_x^2(1)]^{1/2}$$

where $z_{\alpha/2}$ is the upper $\alpha/2$ percentage point of the standard normal distribution. To actually compute an interval, we must replace the parameters β_1 , σ_a^2 and $\sigma_x^2(1)$ by estimates, resulting in

$$\hat{y}_{T+1}(T) \pm z_{\alpha/2} [\hat{\sigma}_a^2 + \hat{\beta}_1^2 \hat{\sigma}_x^2(1)]^{1/2} \quad (14.23)$$

as the PI. Because the parameters have been replaced by estimates, the probability level on the PI in Eq. (14.23) is only approximate.

In general, if we want to forecast τ periods ahead, the forecasting equation is

$$\hat{y}_{T+\tau}(T) = \hat{\phi} \hat{y}_{T+\tau-1}(T) + (1 - \hat{\phi}) \hat{\beta}_0 + \hat{\beta}_1 [\hat{x}_{T+\tau}(T) - \hat{\phi} \hat{x}_{T+\tau-1}(T)] \quad (14.24)$$

The τ -step-ahead forecast error is, assuming that the model parameters are known,

$$y_{T+\tau} - \hat{y}_{T+\tau}(T) = a_{T+\tau} + \phi a_{T+\tau-1} + \dots + \phi^{\tau-1} a_{T+1} + \beta_1 [x_{T+\tau} - \hat{x}_{T+\tau}(T)]$$

and the variance of the τ -step-ahead forecast error is

$$\begin{aligned} V(a_{T+\tau} + \phi a_{T+\tau-1} + \dots + \phi^{\tau-1} a_{T+1}) &= (1 + \phi^2 + \dots + \phi^{2(\tau-1)}) \sigma_a^2 + \beta_1^2 \sigma_x^2(\tau) \\ &= \frac{1 - \phi^{2\tau}}{1 + \phi^2} \sigma_a^2 + \beta_1^2 \sigma_x^2(\tau) \end{aligned}$$

where $\sigma_x^2(\tau)$ is the variance of the τ -step-ahead forecast error for the predictor variable x . A 100(1- α)% PI for the lead- τ forecast from Eq. (14.24) is

$$\hat{y}_{T+\tau}(T) \pm z_{\alpha/2} \left(\frac{1 - \phi^{2\tau}}{1 + \phi^2} \sigma_a^2 + \beta_1^2 \sigma_x^2(\tau) \right)^{1/2}$$

Replacing all of the unknown parameters by estimates, the approximate 100(1- α)% PI is actually computed from

$$\hat{y}_{T+\tau}(T) \pm z_{\alpha/2} \left(\frac{1 - \hat{\phi}^{2\tau}}{1 + \hat{\phi}^2} \hat{\sigma}_a^2 + \hat{\beta}_1^2 \hat{\sigma}_x^2(\tau) \right)^{1/2} \quad (14.25)$$

Alternate Forms of the Model The regression model with autocorrelated errors

$$y_t = \phi y_{t-1} + (1 - \phi) \beta_0 + \beta_1 (x_t - \phi x_{t-1}) + a_t$$

is a very useful model for forecasting time-series regression data. However, when using this model there are two alternatives that should be considered. The first of these is

$$y_t = \phi y_{t-1} + \beta_0 + \beta_1 x_t + \beta_2 x_{t-1} + a_t \quad (14.26)$$

This model removes the requirement that the regression coefficient for the lagged predictor variable x_{t-1} be equal to $-\beta_1 \phi$. An advantage of this model is that it can be fit by ordinary least squares. Another alternative model to consider is to simply drop the lagged value of the predictor variable from Eq. (14.26), resulting in

$$y_t = \phi y_{t-1} + \beta_0 + \beta_1 x_t + a_t \quad (14.27)$$

Often just including the lagged value of the response variable is sufficient and Eq. (14.27) will be satisfactory.

The choice between models should always be a data-driven decision. The different models can be fit to the available data, and model selection can be based in the criteria that we have discussed previously, such as model adequacy checking and residual analysis, and (if enough data are available to do so split the data into an estimation set to fit the model and then evaluate how the different models perform on the remaining test or evaluation data set) forecasting performance over a test or trial period of data. See Montgomery, Jennings, and Kulahci (2008) for more discussion.

Example 14.5

Reconsider the toothpaste market share data originally presented in Example 14.3 and modeling with a time series regression model with first-order autoregressive errors in Example 14.4. First we will try fitting the model in Eq. (14.26). This model simply relaxes the restriction that the regression coefficient for the lagged predictor variable x_{t-1} (price in this example) be equal to $-\beta_1\phi$. Since this is just a linear regression model, we can fit it using Minitab. Table 14.10 contains the Minitab results.

This model is a good fit to the data. The Durbin–Watson Statistic is $d = 2.04203$, which indicates no problems with autocorrelations in the residuals. However, note that the t -statistic for the lagged predictor variable (price) is not significant ($P = 0.217$) indicating that this variable could be removed from the model. If x_{t-1} is removed then the model becomes the one in Eq. (14.27). The Minitab output for this model is in Table 14.11.

TABLE 14.10 Minitab Results for Fitting Model (14.26) to the Toothpaste Market Share Data

Regression Analysis: y versus y(t-1), x, x(t-1)

The regression equation is

$$y = 16.1 + 0.425 y(t-1) - 22.2 x + 7.56 x(t-1)$$

Predictor	Coef	SE Coef	T	P
Constant	16.100	6.095	2.64	0.019
y(t-1)	0.4253	0.2239	1.90	0.077
x	-22.250	2.488	-8.94	0.000
x(t-1)	7.562	5.872	1.29	0.217

S = 0.402205 R-Sq = 96.0% R-Sq(adj) = 95.2%

Analysis of Variance

Source	DF	SS	MS	F	P
Regression	3	58.225	19.408	119.97	0.000
Residual Error	15	2.427	0.162		
Total	18	60.651			

Source	DF	Seq SS
y(t-1)	1	44.768
x	1	13.188
x(t-1)	1	0.268

Durbin-Watson statistic = 2.04203

TABLE 14.11 Minitab Results for Fitting Model (14.27) to the Toothpaste Market Share Data**Regression Analysis: y versus y(t-1), x**

The regression equation is

$$y = 23.3 + 0.162 y(t-1) - 21.2 x$$

Predictor	Coef	SE Coef	T	P
Constant	23.279	2.515	9.26	0.000
y(t-1)	0.16172	0.09238	1.75	0.099
x	-21.181	2.394	-8.85	0.000

S = 0.410394 R-Sq = 95.6% R-Sq(adj) = 95.0%

Analysis of Variance

Source	DF	SS	MS	F	P
Regression	2	57.956	28.978	172.06	0.000
Residual Error	16	2.695	0.168		
Total	18	60.651			

Source	DF	Seq SS
y(t-1)	1	44.768
x	1	13.188

Durbin-Watson statistic = 1.61416

This model is also a good fit to the data. Both predictors, the lagged variable y_{t-1} and x_t , are significant. The Durbin–Watson statistic does not indicate any significant problems with autocorrelation. It seems that either of these models would be reasonable ones for the toothpaste market share data. The advantage of these models relative to the time series regression model with autocorrelated errors is that they can be fit by ordinary least squares. In this example, including a lagged response variable and a lagged predictor variable has essentially eliminated any problems with autocorrelated errors. ■

PROBLEMS

- 14.1** Table B.17 contains data on the global mean surface air temperature anomaly and the global CO₂ concentration. Fit a regression model to these data, using the global CO₂ concentration as the predictor. Analyze the residuals from this model. Is there evidence of autocorrelation in these data? If so, use one iteration of the Cochrane–Orcutt method to estimate the parameters.
- 14.2** Table B.18 contains hourly yield measurements from a chemical process and the process operating temperature. Fit a regression model to these data with the Cochrane–Orcutt method, using the temperature as the predictor. Analyze the residuals from this model. Is there evidence of autocorrelation in these data?
- 14.3** The data in the table below give the percentage share of market of a particular brand of canned peaches (y_t) for the past 15 months and the relative selling price (x_t).

- a. Fit a simple linear regression model to these data. Plot the residuals versus time. Is there any indication of autocorrelation?
- b. Use the Durbin–Watson test to determine if there is positive autocorrelation in the errors. What are your conclusions?
- c. Use one iteration of the Cochrane–Orcutt procedure to estimate the regression coefficients. Find the standard errors of these regression coefficients.
- d. Is there positive autocorrelation remaining after the first iteration? Would you conclude that the iterative parameter estimation technique has been successful?

Market Share and Price of Canned Peaches

t	x_t	y_t	t	x_t	y_t
1	100	15.93	9	85	16.60
2	98	16.26	10	83	17.16
3	100	15.94	11	81	17.77
4	89	16.81	12	79	18.05
5	95	15.67	13	90	16.78
6	87	16.47	14	77	18.17
7	93	15.66	15	78	17.25
8	82	16.94			

- 14.4** The data in the following table gives the monthly sales for a cosmetics manufacturer (y_t) and the corresponding monthly sales for the entire industry (x_t). The units of both variables are millions of dollars.
- a. Build a simple linear regression model relating company sales to industry sales. Plot the residuals against time. Is there any indication of autocorrelation?
 - b. Use the Durbin–Watson test to determine if there is positive autocorrelation in the errors. What are your conclusions?
 - c. Use one iteration of the Cochrane–Orcutt procedure to estimate the model parameters. Compare the standard error of these regression coefficients with the standard error of the least-squares estimates.
 - d. Test for positive autocorrelation following the first iteration. Has the procedure been successful?

Cosmetic Sales Data for Exercise 14.4

t	x_t	y_t	t	x_t	y_t
1	5.00	0.318	10	6.16	0.650
2	5.06	0.330	11	6.22	0.685
3	5.12	0.356	12	6.31	0.713
4	5.10	0.334	13	6.38	0.724
5	5.35	0.386	14	6.54	0.775
6	5.57	0.455	15	6.68	0.78
7	5.61	0.460	16	6.73	0.796
8	5.80	0.527	17	6.89	0.859
9	6.04	0.598	18	6.97	0.88

14.5 Reconsider the data in Exercise 14.4. Define a new set of transformed variables as the first difference of the original variables, $y'_t = y_t - y_{t-1}$ and $x'_t = x_t - x_{t-1}$. Regress y'_t on x'_t through the origin. Compare the estimate of the slope from this first-difference approach with the estimate obtained from the iterative method in Exercise 14.4.

14.6 Consider the simple linear regression model $y_t = \beta_0 + \beta_1 x_t + \varepsilon_t$, where the error are generated by the second-order autoregressive process

$$\varepsilon_t = \rho_1 \varepsilon_{t-1} + \rho_2 \varepsilon_{t-2} + a_t$$

Discuss how the Cochrane–Orcutt iterative procedure could be used in this situation. What transformations would be used on the variable y_t and x_t ? How would you estimate the parameters ρ_1 and ρ_2 ?

14.7 Consider the weighted least squares normal equations for the case of simple linear regression where time is the predictor variable. Suppose that the variances of the errors are proportional to the index of time such that $w_t = 1/t$. Simplify the normal equations for this situation. Solve for the estimates of the model parameters.

14.8 Consider a simple linear regression model where time is the predictor variable. Assume that the errors are uncorrelated and have constant variance σ^2 . Show that the variances of the model parameter estimates are

$$V(\hat{\beta}_0) = \sigma^2 \frac{2(2T+1)}{T(T-1)}$$

and

$$V(\hat{\beta}_1) = \sigma^2 \frac{12}{T(T^2-1)}$$

14.9 Consider the data in Exercise 14.3. Fit a time series regression model with autocorrected errors to these data. Compare this model with the results you obtained in Exercise 14.3 using the Cochrane–Orcutt procedure.

14.10 Consider the data in Exercise 14.3. Fit the lagged variables regression models shown in Eq. (14.26) and (14.27) to these data. Compare these models with the results you obtained in Exercise 14.3 using the Cochrane–Orcutt procedure, and with the time series regression model from Exercise 14.9.

14.11 Consider the cosmetic sales data in Exercise 14.4. Fit a time series regression model with autocorrected errors to these data. Compare this model with the results you obtained in Exercise 14.4 using the Cochrane–Orcutt procedure.

14.12 Consider the cosmetic sales data in Exercise 14.4. Fit the lagged variables regression models shown in Eq. (14.26) and (14.27) to these data. Compare these models with the results you obtained in Exercise 14.4 using the

Cochrane–Orcutt procedure, and with the time series regression model from Exercise 14.11.

- 14.13** Consider the global surface air temperature anomaly data and the CO₂ concentration data in Table B.17. Fit a time series regression model to these data, using global surface air temperature anomaly as the response variable. Is there any indication of autocorrelation in the residuals? What corrective action and modeling strategies would you recommend?

CHAPTER 15

OTHER TOPICS IN THE USE OF REGRESSION ANALYSIS

This chapter surveys a variety of topics that arise in the use of regression analysis. In several cases only a brief glimpse of the subject is given along with references to more complete presentations.

15.1 ROBUST REGRESSION

15.1.1 Need for Robust Regression

When the observations \mathbf{y} in the linear regression model $\mathbf{y} = \mathbf{X}\boldsymbol{\beta} + \boldsymbol{\varepsilon}$ are normally distributed, the method of least squares is a good parameter estimation procedure in the sense that it produces an estimator of the parameter vector $\boldsymbol{\beta}$ that has good statistical properties. However, there are many situations where we have evidence that the distribution of the response variable is (considerably) nonnormal and/or there are outliers that affect the regression model. A case of considerable practical interest is one in which the observations follow a distribution that has longer or heavier tails than the normal. These heavy-tailed distributions tend to generate outliers, and these outliers may have a strong influence on the method of least squares in the sense that they “pull” the regression equation too much in their direction.

For example, consider the 10 observations shown in Figure 15.1. The point labeled *A* in this figure is just at the right end of the x space, but it has a response value that is near the average of the other 9 responses. If all the observations are considered, the resulting regression model is $\hat{y} = 2.12 + 0.971x$, and $R^2 = 0.526$. However, if we

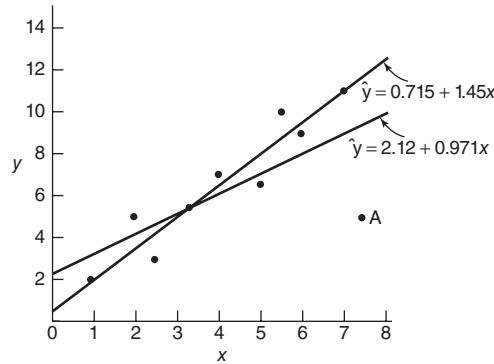

Figure 15.1 A scatter diagram of a sample containing an influential observation.

fit the linear regression model to all observations **other** than observation A, we obtain $\hat{y} = 0.715 + 1.45x$, for which $R^2 = 0.894$. Both lines are shown in Figure 15.1. Clearly, point A has had a dramatic effect on the regression model and the resulting value of R^2 .

One way to deal with this situation is to discard observation A. This will produce a line that passes nicely through the rest of the data and one that is more pleasing from a statistical standpoint. However, we are now discarding observations simply because it is expedient from a statistical modeling viewpoint, and generally, this is not a good practice. Data can sometimes be discarded (or modified) on the basis of **subject-matter** knowledge, but when we do this purely on a statistical basis, we are usually asking for trouble. We also note that in more complicated situations, involving more regressors and a larger sample, even detecting that the regression model has been distorted by observations such as A can be difficult.

A **robust regression procedure** is one that dampens the effect of observations that would be highly influential if least squares were used. That is, a robust procedure tends to leave the residuals associated with outliers large, thereby making the identification of influential points much easier. In addition to insensitivity to outliers, a robust estimation procedure should produce essentially the same results as least squares when the underlying distribution is normal and there are no outliers. Another desirable goal for robust regression is that the estimation procedures and reference procedures should be relatively easy to perform.

The motivation for much of the work in robust regression was the Princeton robustness study (see Andrews et al. [1972]). Subsequently, there have been several types of robust estimators proposed. Some important basic references include Andrews [1974], Carroll and Ruppert [1988], Hogg [1974, 1979a,b], Huber [1972, 1973, 1981], Krasker and Welsch [1982], Rousseeuw [1984, 1998], and Rousseeuw and Leroy [1987].

To motivate some of the following discussion and to further demonstrate why it may be desirable to use an alternative to least squares when the observations are nonnormal, consider the simple linear regression model

$$y_i = \beta_0 + \beta_1 x_i + \varepsilon_i, \quad i = 1, 2, \dots, n \tag{15.1}$$

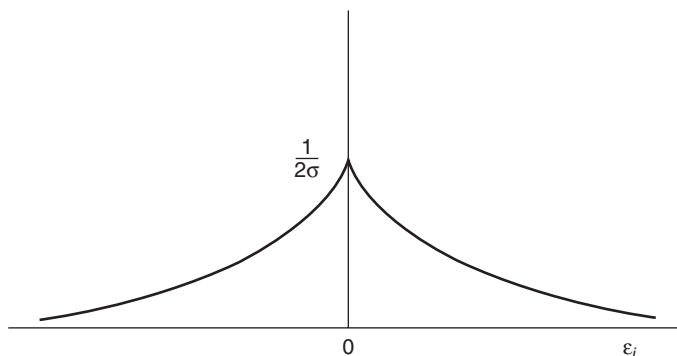

Figure 15.2 The double-exponential distribution.

where the errors are independent random variables that follow the **double exponential distribution**

$$f(\varepsilon_i) = \frac{1}{2\sigma} e^{-|\varepsilon_i|/\sigma}, \quad -\infty < \varepsilon_i < \infty \quad (15.2)$$

The double-exponential distribution is shown in Figure 15.2. The distribution is more “peaked” in the middle than the normal and tails off to zero as $|\varepsilon_i|$ goes to infinity. However, since the density function goes to zero as $e^{-|\varepsilon_i|}$ goes to zero and the normal density function goes to zero as $e^{-\varepsilon_i^2}$ goes to zero, we see that the double-exponential distribution has **heavier tails** than the normal.

We will use the method of **maximum likelihood** to estimate β_0 and β_1 . The likelihood function is

$$L(\beta_0, \beta_1) = \prod_{i=1}^n \frac{1}{2\sigma} e^{-|\varepsilon_i|/\sigma} = \frac{1}{(2\sigma)^n} \exp\left(-\frac{\sum_{i=1}^n |\varepsilon_i|}{\sigma}\right) \quad (15.3)$$

Therefore, maximizing the likelihood function would involve minimizing $\sum_{i=1}^n |\varepsilon_i|$, the sum of the absolute errors. Recall that the method of maximum likelihood applied to the regression model with normal errors leads to the least-squares criterion. Thus, the assumption of an error distribution with heavier tails than the normal implies that the method of least squares is no longer an optimal estimation technique. Note that the absolute error criterion would weight outliers far less severely than would least squares. Minimizing the sum of the absolute errors is often called the L_1 -norm regression problem (least squares is the L_2 -norm regression problem). This criterion was first suggested by F. Y. Edgeworth in 1887, who argued that least squares was overly influenced by large outliers. One way to solve the problem is through a linear programming approach. For more details on L_1 -norm regression, see Sielken and Hartley [1973], Book et al. [1980], Gentle, Kennedy, and Sposito [1977], Bloomfield and Steiger [1983], and Dodge [1987].

The L_1 -norm regression problem is a special case of L_p -norm regression, in which the model parameters are chosen to minimize $\sum_{i=1}^n |\epsilon_i|^p$ where $1 \leq p \leq 2$. When $1 < p < 2$, the problem can be formulated and solved using nonlinear programming techniques. Forsythe [1972] has studied this procedure extensively for the simple linear regression model.

15.1.2 M-Estimators

The L_1 -norm regression problem arises naturally from the maximum-likelihood approach with double-exponential errors. In general, we may define a **class of robust estimators** that minimize a function ρ of the residuals, for example,

$$\text{Minimize}_{\beta} \sum_{i=1}^n \rho(e_i) = \text{Minimize}_{\beta} \sum_{i=1}^n \rho(y_i - \mathbf{x}'_i \beta) \tag{15.4}$$

where \mathbf{x}'_i denotes the i th row of \mathbf{X} . An estimator of this type is called an **M-estimator**, where M stands for **maximum-likelihood**. That is, the function ρ is related to the likelihood function for an appropriate choice of the error distribution. For example, if the method of least squares is used (implying that the error distribution is normal), then $\rho(z) = \frac{1}{2} z^2, -\infty < z < \infty$.

The M -estimator is not necessarily scale invariant [i.e., if the errors $y_i - \mathbf{x}'_i \beta$ were multiplied by a constant, the new solution to Eq. (15.4) might not be same as the old one]. To obtain a scale-invariant version of this estimator, we usually solve

$$\text{Minimize}_{\beta} \sum_{i=1}^n \rho\left(\frac{e_i}{s}\right) = \text{Minimize}_{\beta} \sum_{i=1}^n \rho\left(\frac{y_i - \mathbf{x}'_i \beta}{s}\right) \tag{15.5}$$

where s is a robust estimate of scale. A popular choice for s is the median absolute deviation

$$s = \text{median}|e_i - \text{median}(e_i)|/0.6745 \tag{15.6}$$

The tuning constant 0.6745 makes s an approximately unbiased estimator of σ if n is large and the error distribution is normal

To minimize Eq. (15.5), equate the first partial derivatives of ρ with respect to β_j ($j = 0, 1, \dots, k$) to zero, yielding a necessary condition for a minimum. This gives the system of $p = k + 1$ equations

$$\sum_{i=1}^n x_{ij} \psi\left(\frac{y_i - \mathbf{x}'_i \beta}{s}\right) = 0, \quad j = 0, 1, \dots, k \tag{15.7}$$

where $\psi = \rho'$ and x_{ij} is the i th observation on the j th regressor and $x_{i0} = 1$. In general, the ψ function is nonlinear and Eq. (15.7) must be solved by iterative methods. While several nonlinear optimization techniques could be employed, **iteratively reweighted least squares** (IRLS) is most widely used. This approach is usually attributed to Beaton and Tukey [1974].

To use iteratively reweighted least squares, suppose that an initial estimate $\hat{\boldsymbol{\beta}}_0$ is available and that s is an estimate of scale. Then write the $p = k + 1$ equations in Eq. (15.7),

$$\sum_{i=1}^n x_{ij} \psi \left(\frac{y_i - \mathbf{x}'_i \boldsymbol{\beta}}{s} \right) = \sum_{i=1}^n \frac{x_{ij} \{ \psi [(y_i - \mathbf{x}'_i \boldsymbol{\beta})/s] / (y_i - \mathbf{x}'_i \boldsymbol{\beta})/s \} (y_i - \mathbf{x}'_i \boldsymbol{\beta})}{s} = 0, \quad j = 0, 1, \dots, k \quad (15.8)$$

as

$$\sum_{i=1}^n x_{ij} w_{i0} (y_i - \mathbf{x}'_i \boldsymbol{\beta}) = 0, \quad j = 0, 1, \dots, k \quad (15.9)$$

where

$$w_{i0} = \begin{cases} \frac{\psi \left[\frac{(y_i - \mathbf{x}'_i \hat{\boldsymbol{\beta}}_0)}{s} \right]}{\left(\frac{y_i - \mathbf{x}'_i \hat{\boldsymbol{\beta}}_0}{s} \right)} & \text{if } y_i \neq \mathbf{x}'_i \hat{\boldsymbol{\beta}}_0 \\ 1 & \text{if } y_i = \mathbf{x}'_i \hat{\boldsymbol{\beta}}_0 \end{cases} \quad (15.10)$$

In matrix notation, Eq. (15.9) becomes

$$\mathbf{X}' \mathbf{W}_0 \mathbf{X} \boldsymbol{\beta} = \mathbf{X}' \mathbf{W}_0 \mathbf{y} \quad (15.11)$$

where \mathbf{W}_0 is an $n \times n$ diagonal matrix of “weights” with diagonal elements $w_{10}, w_{20}, \dots, w_{n0}$ given by Eq. (15.10). We recognize Eq. (15.11) as the usual weighted least-squares normal equations. Consequently, the **one-step estimator** is

$$\hat{\boldsymbol{\beta}}_1 = (\mathbf{X}' \mathbf{W}_0 \mathbf{X})^{-1} \mathbf{X}' \mathbf{W}_0 \mathbf{y} \quad (15.12)$$

At the next step we recompute the weights from Eq. (15.10) but using $\hat{\boldsymbol{\beta}}_1$ instead of $\hat{\boldsymbol{\beta}}_0$. Usually only a few iterations are required to achieve convergence. The iteratively reweighted least-squares procedure could be implemented using a standard weighted least-squares computer program.

A number of popular robust criterion functions are shown in Table 15.1 behavior of these ρ functions and their corresponding ψ functions are illustrated in Figures 15.3 and 15.4, respectively. Robust regression procedures can be classified by the behavior of their ψ function. The ψ function controls the weight given to each residual and (apart from a constant of proportionality) is sometimes called the **influence function**. For example, the ψ function for least squares is unbounded, and thus least squares tends to be nonrobust when used with data arising from a heavy-tailed distribution. The Huber t function (Huber [1964]) has a **monotone** ψ function and does not weight large residuals as heavily as least squares. The last three influence functions actually **redescend** as the residual becomes larger. Ramsay’s E_a function (see Ramsay [1977]) is a **soft redescender**, that is, the ψ function is asymptotic to zero for large $|z|$. Andrew’s wave

TABLE 15.1 Robust Criterion Functions

Criterion	$p(z)$	$\psi(z)$	$w(z)$	Range
Least squares	$\frac{1}{2}z^2$	z	1.0	$ z < \infty$
Huber's t function	$\frac{1}{2}z^2$	z	1.0	$ z \leq t$
$t = 2$	$ z t - \frac{1}{2}t^2$	$t \text{ sign}(z)$	$\frac{t}{ z }$	$ z > t$
Ramsay's E_a function $a = 0.3$	$a^{-2}[1 - \exp(-a z) \cdot (1 + a z)]$	$z \exp(-a z)$	$\exp(-a z)$	$ z < \infty$
Andrews'; wave function $a = 1.339$	$a[1 - \cos(z/a)]$	$\sin(z/a)$	$\frac{\sin(z/a)}{z/a}$	$ z \leq a\pi$
Hampel's 17A function $a = 1.7$ $b = 3.4$ $c = 8.5$	$2a$	0	0	$ z > a\pi$
	$\frac{1}{2}z^2$	z	1.0	$ z \leq a$
	$a z - \frac{1}{2}a^2$	$a \sin(z)$	$a/ z $	$a < z \leq b$
	$\frac{a(c z - \frac{1}{2}z^2)}{c-b} - (7/6)a^2$	$\frac{a \text{sign}(z)(c - z)}{c-b}$	$\frac{a(c - z)}{ z (c-b)}$	$b < z \leq c$
	$a(b + c - a)$	0	0	$ z > c$

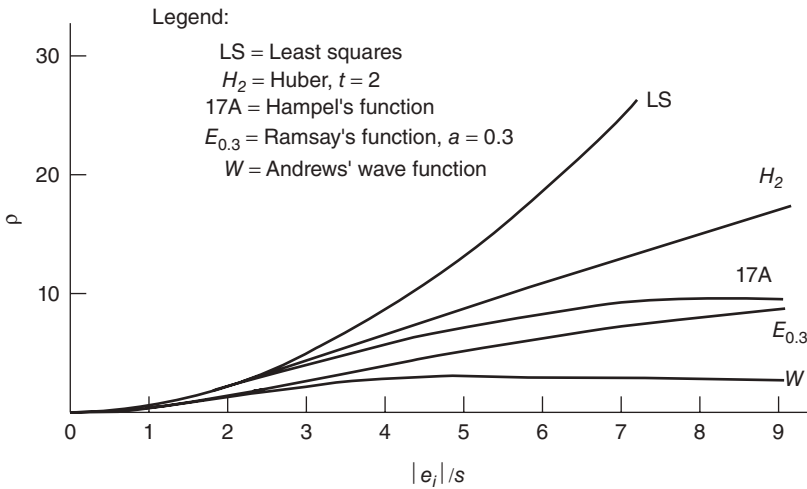

Figure 15.3 Robust criterion functions.

function and Hampel's 17A function (see Andrews et al. [1972] and Andrews [1974]) are **hard redescenders**, that is, the ψ function equals zero for sufficiently large $|z|$. We should note that the ρ functions associated with the redescending ψ functions are nonconvex, and this in theory can cause convergence problems in the iterative estimation procedure. However, this is not a common occurrence. Furthermore, each

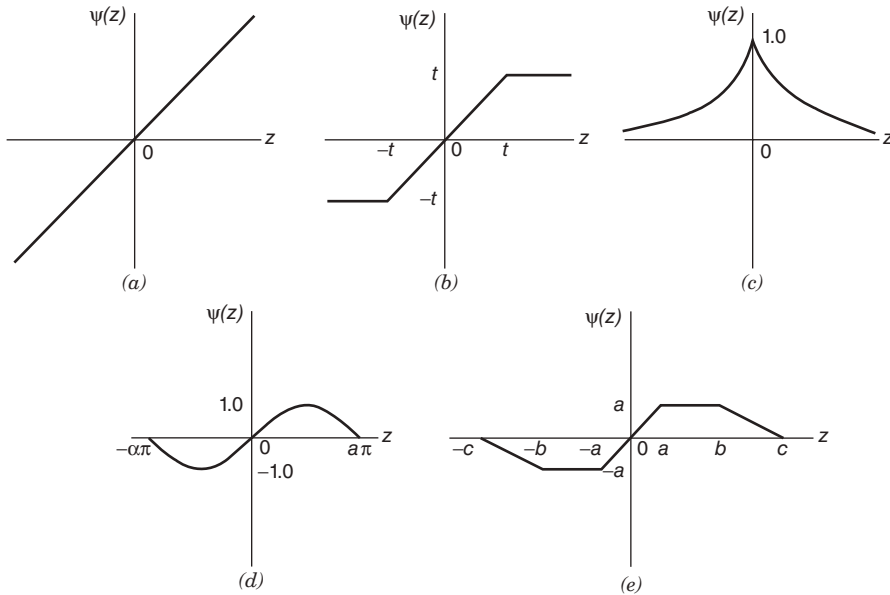

Figure 15.4 Robust influence functions: (a) least squares; (b) Huber's t functions; (c) Ramsay's E_a function; (d) Andrews' wave function; (e) Hampel's 17A function.

of the robust criterion functions requires the analyst to specify certain “tuning constants” for the ψ functions. We have shown typical values of these tuning constants in Table 15.1.

The starting value $\hat{\beta}_0$ used in robust estimation can be an important consideration. Using the least-squares solution can disguise the high leverage points. The L_1 -norm estimates would be a possible choice of starting values. Andrews [1974] and Dutter [1977] also suggest procedures for choosing the starting values.

It is important to know something about the error structure of the final robust regression estimates $\hat{\beta}$. Determining the covariance matrix of $\hat{\beta}$ is important if we are to construct confidence intervals or make other model inferences. Huber [1973] has shown that asymptotically $\hat{\beta}$ has an approximate normal distribution with covariance matrix

$$\sigma^2 \frac{E[\psi^2(\varepsilon/\sigma)]}{\{E\{\psi'(\varepsilon/\sigma)\}\}^2} (\mathbf{X}'\mathbf{X})^{-1}$$

Therefore, a reasonable approximation for the covariance matrix of $\hat{\beta}$ is

$$\frac{ns^2 \sum_{i=1}^n \psi^2[(y_i - \mathbf{x}_i'\hat{\beta})/s]}{n-p \left\{ \sum_{i=1}^n \psi'[(y_i - \mathbf{x}_i'\hat{\beta})/s] \right\}^2} (\mathbf{X}'\mathbf{X})^{-1}$$

The weighted least-squares computer program also produces an estimate of the covariance matrix

$$\frac{\sum_{i=1}^n w_i (y_i - \mathbf{x}'_i \hat{\boldsymbol{\beta}})^2}{n - p} (\mathbf{X}' \mathbf{W} \mathbf{X})^{-1}$$

Other suggestions are in Welsch [1975] and Hill [1979]. There is no general agreement about which approximation to the covariance matrix of $\hat{\boldsymbol{\beta}}$ is best. Both Welsch and Hill note that these covariance matrix estimates perform poorly for \mathbf{X} matrices that have outliers. Ill-conditioning (multicollinearity) also distorts robust regression estimates. However, There are indications that in many cases we can make approximate inferences about $\hat{\boldsymbol{\beta}}$ using procedures similar to the usual normal theory.

Example 15.1 The Stack Loss Data

Andrews [1974] uses the stack loss data analyzed by Daniel and Wood [1980] to illustrate robust regression. The data, which are taken from a plant oxidizing ammonia to nitric acid, are shown in Table 15.2. An ordinary least-squares (OLS) fit to these data gives

$$\hat{y} = -39.9 + 0.72x_1 + 1.30x_2 - 0.15x_3$$

TABLE 15.2 Stack Loss Data from Daniel and Wood [1980]

Observation Number	Stack Loss, y	Air Flow, x_1	Cooling Water Inlet Temperature, x_2	Acid Concentration, x_3
1	42	80	27	89
2	37	80	27	88
3	37	75	25	90
4	28	62	24	87
5	18	62	22	87
6	18	62	23	87
7	19	62	24	93
8	20	62	24	93
9	15	58	23	87
10	14	58	18	80
11	14	58	18	89
12	13	58	17	88
13	11	58	18	82
14	12	58	19	93
15	8	50	18	89
16	7	50	18	86
17	8	50	19	72
18	8	50	19	79
19	9	50	20	80
20	15	56	20	82
21	15	70	20	91

TABLE 15.3 Residuals for Various Fits to the Stack Loss Data^a

Observation	Residuals			
	Least Squares		Andrews'; Robust Fit	
	(1)	(2)	(3)	(4)
	All 21 Points	1, 3, 4, 21 Out	All 21 Points	1,3,4,21 Out
1	3.24	<u>6.08</u> ^b	6.11	<u>6.11</u>
2	-1.92	1.15	1.04	1.04
3	4.56	<u>6.44</u>	6.31	<u>6.31</u>
4	5.70	<u>8.18</u>	8.24	<u>8.24</u>
5	-1.71	-0.67	-1.24	-1.24
6	-3.01	-1.25	-0.71	-0.71
7	-2.39	-0.42	-0.33	-0.33
8	-1.39	0.58	0.67	0.67
9	-3.14	-1.06	-0.97	-0.97
10	1.27	0.35	0.14	0.14
11	2.64	0.96	0.79	0.79
12	2.78	0.47	0.24	0.24
13	-1.43	-2.51	-2.71	-2.71
14	-0.05	-1.34	-1.44	-1.44
15	2.36	1.34	1.33	1.33
16	0.91	0.14	0.11	0.11
17	-1.52	-0.37	-0.42	-0.42
18	-0.46	0.10	0.08	0.08
19	-0.60	0.59	0.63	0.63
20	1.41	1.93	1.87	1.87
21	-7.24	<u>-8.63</u>	-8.91	<u>-8.91</u>

^aAdapted from Table 5 in Andrews [1974], with permission of the publisher.

^bUnderlined residuals correspond to points not included in the fit.

The residuals from this model are shown in column 1 of Table 15.3 and a normal probability plot is shown in Figure 15.5a. Daniel and Wood note that the residual for point 21 is unusually large and has considerable influence on the regression coefficients. After an insightful analysis, they delete points 1, 3, 4, and 21 from the data. The OLS fit[†] to the remaining data yields

$$\hat{y} = -37.6 + 0.80x_1 + 0.58x_2 - 0.07x_3$$

The residuals from this model are shown in column 2 of Table 15.3, and the corresponding normal probability plot is in Figure 15.5b. This plot does not indicate any unusual behavior in the residuals.

Andrews [1974] observes that most users of regression lack the skills of Daniel and Wood and employs robust regression methods to produce equivalent results. A robust fit to the stack loss data using the wave function with $a = 1.5$ yields

[†]Daniel and Wood fit a model involving x_1 , x_2 , and x_1^2 . Andrews elected to work with all three original regressors. He notes that if x_3 is deleted and x_1^2 added, smaller residuals result but the general findings are the same.

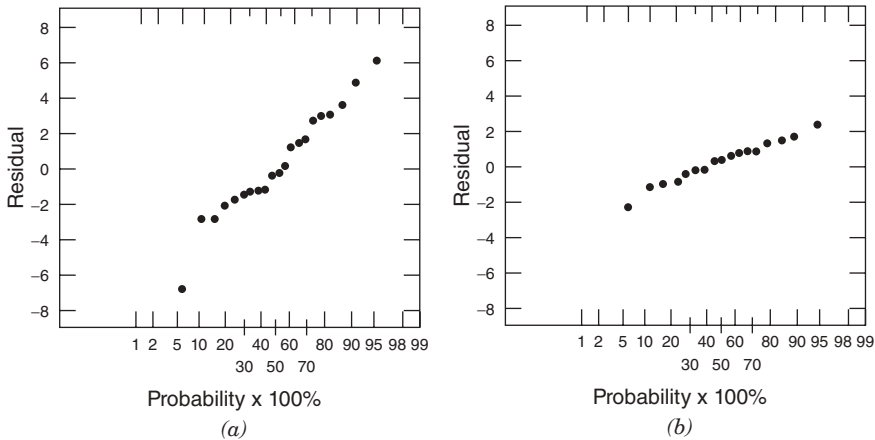

Figure 15.5 Normal probability plots from least-squares fits: (a) least squares with all 21 points; (b) least squares with 1, 3, 4, and 21 deleted. (From Andrews [1974], with permission of the publisher.)

$$\hat{y} = -37.2 + 0.82x_1 + 0.52x_2 - 0.07x_3$$

This is virtually the same equation found by Daniel and Wood using OLS after much careful analysis. The residuals from this model are shown in column 3 of Table 15.3, and the normal probability plot is in Figure 15.6a. The four suspicious points are clearly identified in this plot. Finally, Andrews obtains a robust fit to the data with points 1, 3, 4, and 21 removed. The resulting equation is identical to the one found using all 21 data points. The residuals from this fit and the corresponding normal probability plot are shown in column 4 of Table 15.3 and Figure 15.6b, respectively. This normal probability plot is virtually identical to the one obtained from the OLS analysis with points 1, 3, 4, and 21 deleted (Figure 15.5b).

Once again we find that the routine application of robust regression has led to the automatic identification of the suspicious points. It has also produced a fit that does not depend on these points in any important way. Thus, robust regression methods can be viewed as procedures for isolating unusually influential points, so that these points may be given further study. ■

Computing *M*-Estimates Not many statistical software packages compute *M*-estimates. S-PLUS and STATA do have this capability. SAS recently added it. The SAS code to analyze the stack loss data is:

```
proc robustreg;
    model y = x1 x2 x3 / diagnostics leverage;
run;
```

SAS's default procedure uses the bisquare weight function (see Problem 15.3) and the median method for estimating the scale parameter.

Robust regression methods have much to offer the data analyst. They can be extremely helpful in locating outliers and highly influential observations. Whenever

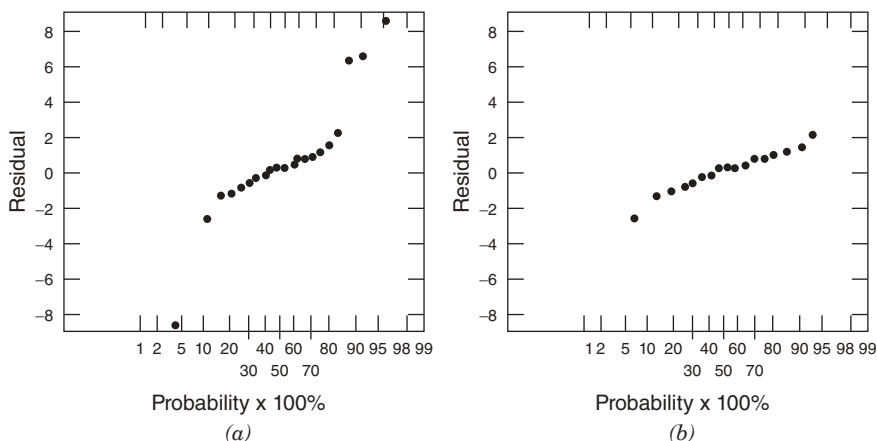

Figure 15.6 Normal probability plots from robust fits: (a) robust fit with all 21 points; (b) robust fit with 1, 3, 4, and 21 deleted. (From Andrews [1974], with permission of the publisher.)

a least-squares analysis is performed, it would be useful to perform a robust fit also. If the results of the two procedures are in substantial agreement, then use the least-squares results, because inferences based on least squares are at present better understood. However, if the results of the two analyses differ, then reasons for these differences should be identified. Observations that are downweighted in the robust fit should be carefully examined.

15.1.3 Properties of Robust Estimators

In this section we introduce two important properties of robust estimators: **breakdown** and **efficiency**. We will observe that the breakdown point of an estimator is a practical concern that should be taken into account when selecting a robust estimation procedure. Generally, M -estimates perform poorly with respect to breakdown point. This has spurred development of many other alternative procedures.

Breakdown Point The finite-sample **breakdown point** is the smallest fraction of anomalous data that can cause the estimator to be useless. The smallest possible breakdown point is $1/n$, that is, a single observation can distort the estimator so badly that it is of no practical use to the regression model-builder. The breakdown point of OLS is $1/n$.

M -estimates can be affected by x -space outliers in an identical manner to OLS. Consequently, the breakdown point of the class of M -estimators is $1/n$. This has a potentially serious impact on their practical use, since it can be difficult to determine the extent to which the sample is contaminated with anomalous data. Most experienced data analysts believe that the fraction of data that are contaminated by erroneous data typically varies between 1 and 10%. Therefore, we would generally want the breakdown point of an estimator to exceed 10%. This has led to the development of **high-breakdown-point estimators**.

Efficiency Suppose that a data set has no gross errors, there are no influential observations, and the observations come from a normal distribution. If we use a robust estimator on such a data set, we would want the results to be virtually identical to OLS, since OLS is the appropriate technique for such data. The efficiency of a robust estimator can be thought of as the residual mean square obtained from OLS divided by the residual mean square from the robust procedure. Obviously, we want this efficiency measure to be close to unity.

There is a lot of emphasis in the robust regression literature on **asymptotic efficiency**, that is, the efficiency of an estimator as the sample size n becomes infinite. This is a useful concept in comparing robust estimators, but many practical regression problems involve small to moderate sample sizes ($n < 50$, for instance), and small-sample efficiencies are known to differ dramatically from their asymptotic values. Consequently, a model-builder should be interested in the asymptotic behavior of any estimator that might be used in a given situation but should not be unduly excited about it. What is more important from a practical viewpoint is the **finite-sample efficiency**, or how well a particular estimator works with reference to OLS on “clean” data for sample sizes consistent with those of interest in the problem at hand. The finite-sample efficiency of a robust estimator is defined as the ratio of the OLS residual mean square to the robust estimator residual mean square, where OLS is applied only to the clean data. Monte Carlo simulation methods are often used to evaluate finite-sample efficiency.

15.2 EFFECT OF MEASUREMENT ERRORS IN THE REGRESSORS

In almost all regression models we assume that the response variable y is subject to the error term ε and that the regressor variables x_1, x_2, \dots, x_k are **deterministic** or **mathematical variables**, not affected by error. There are two variations of this situation. The first is the case where the response and the regressors are **jointly distributed random variables**. This assumption gives rise to the **correlation model** discussed in Chapter 2 (refer to Section 2.12). The second is the situation where there are **measurement errors** in the response and the regressors. Now if measurement errors are present only in the response variable y , there are no new problems so long as these errors are uncorrelated and have no bias (zero expectation). However, a different situation occurs when there are measurement errors in the x 's. We consider this problem in this section.

15.2.1 Simple Linear Regression

Suppose that we wish to fit the simple linear regression model, but the regressor is measured with error, so that the observed regressor is

$$X_i = x_i + a_i, \quad i = 1, 2, \dots, n$$

where x_i is the true value of the regressor, X_i is the observed value, and a_i is the measurement error with $E(a_i) = 0$ and $\text{Var}(a_i) = \sigma_a^2$. The response variable y_i is subject to the usual error ε_i , $i = 1, 2, \dots, n$, so that the regression model is

$$y_i = \beta_0 + \beta_1 x_i + \varepsilon_i \quad (15.13)$$

We assume that the errors ε_i and a_i are uncorrelated, that is, $E(\varepsilon_i a_i) = 0$. This is sometimes called the **errors-in-both-variables model**. Since X_i is the observed value of the regressor, we may write

$$y_i = \beta_0 + \beta_1(X_i - a_i) + \varepsilon_i = \beta_0 + \beta_1 X_i + (\varepsilon_i - \beta_1 a_i) \quad (15.14)$$

Initially Eq. (15.14) may look like an ordinary linear regression model with error term $\gamma_i = \varepsilon_i - \beta_1 a_i$. However, the regressor variable X_i is a random variable and is correlated with the error term $\gamma_i = \varepsilon_i - \beta_1 a_i$. The correlation between X_i and γ_i is easily seen, since

$$\begin{aligned} \text{Cov}(X_i, \gamma_i) &= E\{[X_i - E(X_i)][\gamma_i - E(\gamma_i)]\} \\ &= E[(X_i - x_i)\gamma_i] = E[(X_i - x_i)(\varepsilon_i - \beta_1 a_i)] \\ &= E(a_i \varepsilon_i - \beta_1 a_i^2) = -\beta_1 \sigma_a^2 \end{aligned}$$

Thus, if $\beta_1 \neq 0$, the observed regressor X_i and the error term γ_i are correlated.

The usual assumption when the regressor is a random variable is that the regressor variable and the error component are independent. Violation of this assumption introduces several complexities into the problem. For example, if we apply standard least-squares methods to the data (i.e., ignoring the measurement error), the estimators of the model parameters are no longer unbiased. In fact, we can show that if $\text{Cov}(X_i, \gamma_i) = 0$, then

$$E(\hat{\beta}_1) = \frac{\beta_1}{1 + \theta}$$

where

$$\theta = \frac{\sigma_a^2}{\sigma_x^2} \quad \text{and} \quad \sigma_x^2 = \sum_{i=1}^n \frac{(x_i - \bar{x})^2}{n}$$

That is, $\hat{\beta}_1$ is always a biased estimator of β_1 unless $\sigma_a^2 = 0$, which occurs only when there are no measurement errors in the x_i .

Since measurement error is present to some extent in almost all practical regression situations, some advice for dealing with this problem would be helpful. Note that if σ_a^2 is small relative to σ_x^2 the bias in $\hat{\beta}_1$ will be small. This implies that if the variability in the measurement errors is small relative to the variability of the x 's, then the measurement errors can be ignored and standard least-squares methods applied.

Several **alternative estimation methods** have been proposed to deal with the problem of measurement errors in the variables. Sometimes these techniques are discussed under the topics **structural or functional relationships** in regression. Economists have used a technique called **two-stage least squares** in these cases. Often these methods require more extensive assumptions or information about the parameters of the distribution of measurement errors. Presentations of these methods are in Graybill [1961], Johnston [1972], Sprent [1969], and Wonnacott and Wonnacott [1970]. Other useful references include Davies and Hutton [1975], Dolby [1976], Halperin [1961], Hodges and Moore [1972], Lindley [1974], Mandansky [1959], and

Sprent and Dolby [1980]. Excellent discussions of the subject are also in Draper and Smith [1998] and Seber [1977].

15.2.2 The Berkson Model

Berkson [1950] has investigated a case involving measurement errors in x_i where the method of least squares can be directly applied. His approach consists of setting the observed value of the regressor X_i to a **target value**. This forces X_i to be treated as fixed, while the true value of the regressor $x_i = X_i - a_i$ becomes a random variable. As an example of a situation where this approach could be used, suppose that the current flowing in an electrical circuit is used as a regressor variable. Current flow is measured with an ammeter, which is not completely accurate, so measurement error is experienced. However, by setting the observed current flow to target levels of 100, 125, 150, and 175 A (for example), the **observed current flow** can be considered as **fixed**, and **actual current flow** becomes a **random variable**. This type of problem is frequently encountered in engineering and physical science. The regressor is a variable such as temperature, pressure, or flow rate and there is error present in the measuring instrument used to observe the variable. This approach is also sometimes called the **controlled-independent-variable model**.

If X_i is regarded as fixed at a preassigned target value, then Eq. (15.14), found by using the relationship $X_i = x_i + a_i$, is still appropriate. However, the error term in this model, $\gamma_i = \varepsilon_i - \beta_1 a_i$, is now independent of X_i because X_i is considered to be a fixed or nonstochastic variable. Thus, the errors are uncorrelated with the regressor, and the usual least-squares assumptions are satisfied. Consequently, a standard least-squares analysis is appropriate in this case.

15.3 INVERSE ESTIMATION—THE CALIBRATION PROBLEM

Most regression problems involving prediction or estimation require determining the value of y corresponding to a given x , such as x_0 . In this section we consider the **inverse problem**; that is, given that we have observed a value of y , such as y_0 , determine the x value corresponding to it. For example, suppose we wish to calibrate a thermocouple, and we know that the temperature reading given by the thermocouple is a linear function of the actual temperature, say

$$\text{Observed temperature} = \beta_0 + \beta_1(\text{actual temperature}) + \varepsilon$$

or

$$y = \beta_0 + \beta_1 x + \varepsilon \tag{15.15}$$

Now suppose we measure an unknown temperature with the thermocouple and obtain a reading y_0 . We would like to estimate the actual temperature, that is, the temperature x_0 corresponding to the observed temperature reading y_0 . This situation arises often in engineering and physical science and is sometimes called the **calibration problem**. It also occurs in bioassay where a standard curve is constructed against which all future assays or **discriminations** are to be run.

Suppose that the thermocouple has been subjected to a set of controlled and known temperatures x_1, x_2, \dots, x_n and a set of corresponding temperature readings y_1, y_2, \dots, y_n obtained. One method for estimating x given y would be to fit the model (15.15), giving

$$\hat{y} = \hat{\beta}_0 + \hat{\beta}_1 x \quad (15.16)$$

Now let y_0 be the observed value of y . A natural point estimate of the corresponding value of x is

$$\hat{x}_0 = \frac{y_0 - \hat{\beta}_0}{\hat{\beta}_1} \quad (15.17)$$

assuming that $\hat{\beta}_1 \neq 0$. This approach is often called the **classical estimator**.

Graybill [1976] and Seber [1977] outline a method for creating a 100 $(1 - \alpha)$ percent confidence region for x_0 . Previous editions of this book did recommend this approach. Parker, et al. [2010] show that this method really does not work well. The actual confidence level is much less than the advertised $(1 - \alpha)$ percent. They establish that the interval based on the delta method works quite well. Let n be the number of data points in the calibration data collection. This interval is

$$\hat{x}_0 \pm t_{1-\alpha/2, n-2} \frac{1}{\hat{\beta}_1} \sqrt{MS_{\text{Res}} \left(1 + \frac{1}{n} + \frac{\hat{x}_0 - \bar{x}}{S_{xx}} \right)}$$

where MS_{Res} , \bar{x} , and S_{xx} are all calculated from the data collected from the calibration.

Example 15.2 Thermocouple Calibration

A mechanical engineer is calibrating a thermocouple. He has chosen 16 levels of temperature evenly spaced over the interval 100–400°C. The actual temperature x (measured by a thermometer of known accuracy) and the observed reading on the thermocouple y are shown in Table 15.4 and a scatter diagram is plotted in Figure 15.7. Inspection of the scatter diagram indicates that the observed temperature on the thermocouple is linearly related to the actual temperature. The straight-line model is

$$\hat{y} = -6.67 + 0.953x$$

with $\sigma^2 = MS_{\text{Res}} = 5.86$. The F statistic for this model exceeds 20,000, so we reject $H_0: \beta_1 = 0$ and conclude that the slope of the calibration line is not zero. Residual analysis does not reveal any unusual behavior so this model can be used to obtain point and interval estimates of actual temperature from temperature readings on the thermocouple.

Suppose that a new observation on temperature of $y_0 = 200^\circ\text{C}$ is obtained using the thermocouple. A point estimate of the actual temperature, from the calibration line, is

$$\hat{x}_0 = \frac{y_0 - \hat{\beta}_0}{\hat{\beta}_1} = \frac{200 - (-6.67)}{0.953} = 216.86^\circ\text{C} \tag{15.18}$$

the 95% prediction interval based on (15.18) is $211.21 \leq x_0 \leq 222.5$ ■

TABLE 15.4 Actual and Observed Temperature

Observation, i	Actual Temperature, x_i ($^\circ\text{C}$)	Observed Temperature, y_i ($^\circ\text{C}$)
1	100	88.8
2	120	108.7
3	140	129.8
4	160	146.2
5	180	161.6
6	200	179.9
7	220	202.4
8	240	224.5
9	260	245.1
10	280	257.7
11	300	277.0
12	320	298.1
13	340	318.8
14	360	334.6
15	380	355.2
16	400	377.0

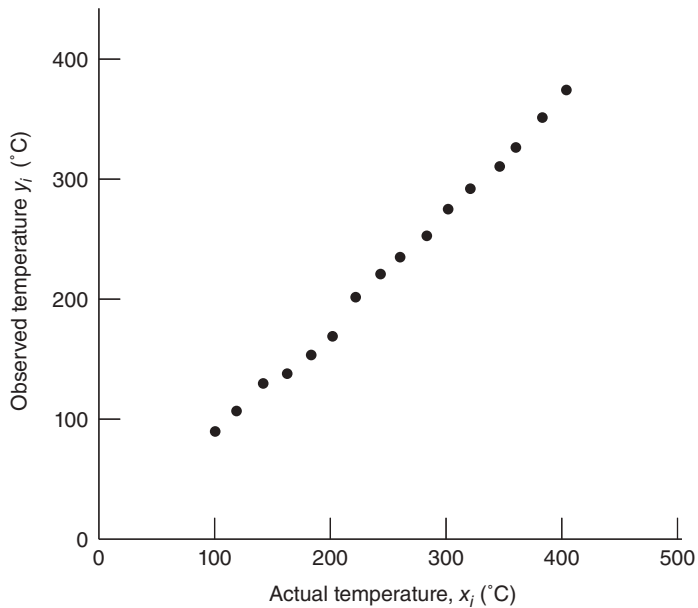

Figure 15.7 Scatterplot of observed and actual temperatures, Example 15.2.

Other Approaches Many people do not find the classical procedure outlined in Example 15.2 entirely satisfactory. Williams [1969] claims that the classical estimator has infinite variance based on the assumption that this estimator follows a Cauchy-like distribution. A Cauchy random variable is the inverse of a standard normal random variable. This standard normal random variable has a mean of 0, which does create problems for the Cauchy distribution. The analyst always can rescale the calibration data such that the slope is one. Typically, the variances for calibration experiments are very small, on the order of $\sigma = 0.01$. In such a case, the slope for the calibration data is approximately 100 standard deviations away from 0. Williams and similar arguments about infinite variance have no practical import.

The biggest practical complaint about the classical estimator is the difficulty in implementing the procedure. Many analysts, particularly outside the classical laboratory-calibration context, prefer **inverse regression**, where the analyst treats the x s in the calibration experiment as the response and the y s as the regressor. Of course, this reversal of roles is problematic in itself. Ordinary least squares regression assumes that the regressors are measured without error and that the response is random. Clearly, inverse regression violates this basic assumption.

Krutchkoff [1967, 1969] performed a series of simulations comparing the classical approach to inverse regression. He concluded that inverse regression was a better approach in terms of mean squared error of prediction. However, Berkson [1969], Halperin [1970], and Williams [1969] criticized Krutchkoff's results and conclusions.

Parker et al. [2010] perform a thorough comparison of the classical approach and inverse regression. They show that both approaches yield biased estimates. The bias for the classical estimator is

$$\frac{(x_0 - \bar{x})\sigma^2}{\beta_1^2 S_{xx}}$$

The bias for inverse regression is approximately

$$-\frac{x_0}{1 + \frac{1}{\sigma^2}}$$

Interestingly, inverse regression suffers from more bias than the classical approach.

Parker et al. conclude that for quite accurate instruments ($\sigma \approx 0.01$), the classical approach and inverse regression yield virtually the same intervals. For borderline instruments ($\sigma \approx 0.1$), inverse regression gives slightly smaller widths. Both procedures yield coverage probabilities as advertised.

A number of other estimators have been proposed. Graybill [1961, 1976] considers the case where we have repeated observations on y at the unknown value of x . He develops point and interval estimates for x using the classical approach. The probability of obtaining a finite confidence interval for the unknown x is greater when those are repeat observations on y . Hoadley [1970] gives a Bayesian treatment of the problem and derives an estimator that is a compromise between the classical and inverse approaches. He notes that the inverse estimator is the Bayes estimator for a particular choice of prior distribution. Other estimators have been proposed

by Kalotay [1971], Naszódi [1978], Perng and Tong [1974], and Tucker [1980]. The paper by Scheffé [1973] is also of interest. In general, Parker et al. [2010] show that these approaches are not satisfactory since the resulting intervals are very conservative with the actual coverage probability much greater than $100(1 - \alpha)$.

In many, if not most, calibration studies the analyst can **design the data collection experiment**. That is, he or she can specify what x values are to be observed. Ott and Myers [1968] have considered the choice of an appropriate design for the inverse estimation problem assuming that the unknown x is estimated by the classical approach. They develop designs that are optimal in the sense of minimizing the integrated mean square error. Figures are provided to assist the analyst in design selection.

15.4 BOOTSTRAPPING IN REGRESSION

For the standard linear regression model, when the assumptions are satisfied, there are procedures available for examining the precision of the estimated regression coefficients, as well as the precision of the estimate of the mean or the prediction of a future observation at any point of interest. These procedures are the familiar standard errors, confidence intervals, and prediction intervals that we have discussed in previous chapters. However, there are many regression model-fitting situations either where there is no standard procedure available or where the results available are only approximate techniques because they are based on large-sample or asymptotic theory. For example, for ridge regression and for many types of robust fitting procedures there is no theory available for construction of confidence intervals or statistical tests, while in both nonlinear regression and generalized linear models the only tests and intervals available are large-sample results.

Bootstrapping is a computer-intensive procedure that was developed to allow us to determine reliable estimates of the standard errors of regression estimates in situations such as we have just described. The bootstrap approach was originally developed by Efron [1979, 1982]. Other important and useful references are Davison and Hinkley [1997], Efron [1987], Efron and Tibshirani [1986, 1993], and Wu [1986]. We will explain and illustrate the bootstrap in the context of finding the standard error of an estimated regression coefficient. The same procedure would be applied to obtain standard errors for the estimate of the mean response or a future observation on the response at a particular point. Subsequently we will show how to obtain approximate confidence intervals through bootstrapping.

Suppose that we have fit a regression model, and our interest focuses on a particular regression coefficient, say $\hat{\beta}$. We wish to estimate the precision of this estimate by the bootstrap method. Now this regression model was fit using a sample of n observations. The bootstrap method requires us to select a random sample of size n with replacement from this original sample. This is called the bootstrap sample. Since it is selected with replacement, the bootstrap sample will contain observations from the original sample, with some of them duplicated and some of them omitted. Then we fit the model to this bootstrap sample, using the same regression procedure as for the original sample. This produces the first bootstrap estimate, say $\hat{\beta}_1^*$. This process is repeated a large number of times. On each repetition, a bootstrap sample is selected, the model is fit, and an estimate $\hat{\beta}_i^*$ is obtained for $i = 1, 2, \dots, m$

bootstrap samples. Because repeated samples are taken from the original sample, bootstrapping is also called a **resampling procedure**. Denote the estimated standard deviation of the m bootstrap estimates $\hat{\beta}_i^*$ by $s(\hat{\beta}^*)$. This **bootstrap standard deviation** $s(\hat{\beta}^*)$ is an estimate of the standard deviation of the sampling distribution of $\hat{\beta}$ and, consequently, it is a measure of the precision of estimation for the regression coefficient β .

15.4.1 Bootstrap Sampling in Regression

We will describe how bootstrap sampling can be applied to a regression model. For convenience, we present the procedures in terms of a linear regression model, but they could be applied to a nonlinear regression model or a generalized linear model in essentially the same way.

There are two basic approaches for bootstrapping regression estimates. In the first approach, we fit the linear regression model $\mathbf{y} = \mathbf{X}\boldsymbol{\beta} + \boldsymbol{\varepsilon}$ and obtain the n residuals $\mathbf{e}' = [e_1, e_2, \dots, e_n]$. Choose a random sample of size n with replacement from these residuals and arrange them in a **bootstrap residual vector** \mathbf{e}^* . Attach the bootstrapped residuals to the predicted values $\hat{\mathbf{y}} = \mathbf{X}\hat{\boldsymbol{\beta}}$ to form a bootstrap vector of responses \mathbf{y}^* . That is, calculate

$$\mathbf{y}^* = \mathbf{X}\hat{\boldsymbol{\beta}} + \mathbf{e}^* \quad (15.19)$$

These bootstrapped responses are now regressed on the original regressors by the regression procedure used to fit the original model. This produces the first bootstrap estimate of the vector of regression coefficients. We could now also obtain bootstrap estimates of any quantity of interest that is a **function** of the parameter estimates. This procedure is usually referred to as **bootstrapping residuals**.

Another bootstrap sampling procedure, usually called **bootstrapping cases** (or bootstrapping **pairs**), is often used in situations where there is some doubt about the adequacy of the regression function being considered or when the error variance is not constant and/or when the regressors are not fixed-type variables. In this variation of bootstrap sampling, it is the n sample **pairs** (\mathbf{x}_i, y_i) that are considered to be the data that are to be resampled. That is, the n original sample pairs (\mathbf{x}_i, y_i) are sampled with replacement n times, yielding a bootstrap sample, say (\mathbf{x}_i^*, y_i^*) for $i = 1, 2, \dots, n$. Then we fit a regression model to this bootstrap sample, say

$$\mathbf{y}^* = \mathbf{X}\hat{\boldsymbol{\beta}} + \boldsymbol{\varepsilon} \quad (15.20)$$

resulting in the first bootstrap estimate of the vector of regression coefficients.

These bootstrap sampling procedures would be repeated m times. Generally, the choice of m depends on the application. Sometimes, reliable results can be obtained from the bootstrap with a fairly small number of bootstrap samples. Typically, however, 200–1000 bootstrap samples are employed. One way to select m is to observe the variability of the bootstrap standard deviation $s(\hat{\beta}^*)$ as m increases. When $s(\hat{\beta}^*)$ stabilizes, a bootstrap sample of adequate size has been reached.

15.4.2 Bootstrap Confidence Intervals

We can use bootstrapping to obtain **approximate confidence intervals** for regression coefficients and other quantities of interest, such as the mean response at a particular point in x space, or an approximate prediction interval for a future observation on the response. As in the previous section, we will focus on regression coefficients, as the extension to other regression quantities is straightforward.

A simple procedure for obtaining an approximate $100(1 - \alpha)$ percent confidence interval through bootstrapping is the **reflection method** (also known as the **percentile method**). This method usually works well when we are working with an unbiased estimator. The reflection confidence interval method uses the lower $100(\alpha/2)$ and upper $100(1 - \alpha/2)$ percentiles of the bootstrap distribution of $\hat{\beta}_i^*$. Let these percentiles be denoted by $\hat{\beta}^*(\alpha/2)$ and $\hat{\beta}^*(1 - \alpha/2)$, respectively. Operationally, we would obtain these percentiles from the sequence of bootstrap estimates that we have computed, $\hat{\beta}_i^*$, $i = 1, 2, \dots, m$. Define the distances of these percentiles from $\hat{\beta}$, the estimate of the regression coefficient obtained for the original sample, as follows:

$$\begin{aligned} D_1 &= \hat{\beta} - \hat{\beta}^*(\alpha/2) \\ D_2 &= \hat{\beta}^*(1 - \alpha/2) - \hat{\beta} \end{aligned} \quad (15.21)$$

Then the approximate $100(1 - \alpha/2)$ percent **bootstrap confidence interval** for the regression coefficient β is given by

$$\hat{\beta} - D_2 \leq \beta \leq \hat{\beta} + D_1 \quad (15.22)$$

Before presenting examples of this procedure, we note two important points:

1. When using the reflection method to construct bootstrap confidence intervals, it is generally a good idea to use a larger number of bootstrap samples than would ordinarily be used to obtain a bootstrap standard error. The reason is that small tail percentiles of the bootstrap distribution are required, and a larger sample will provide more reliable results. Using at least $m = 500$ bootstrap samples is recommended.
2. The confidence interval expression in Eq. (15.22) associates D_2 with the lower confidence limit and D_1 with the upper confidence limit, and at first glance this looks rather odd since D_1 involves the lower percentile of the bootstrap distribution and D_2 involves the upper percentile. To see why this is so, consider the usual sampling distribution of $\hat{\beta}$ for which the lower $100(\alpha/2)$ and upper $100(1 - \alpha/2)$ percentiles are denoted by $\hat{\beta}(\alpha/2)$ and $\hat{\beta}(1 - \alpha/2)$, respectively. Now we can state with probability $100(1 - \alpha/2)$ that $\hat{\beta}$ will fall in the interval

$$\hat{\beta}(\alpha/2) \leq \hat{\beta} \leq \hat{\beta}(1 - \alpha/2) \quad (15.23)$$

Expressing these percentiles in terms of the distances from the mean of the sampling distribution of $\hat{\beta}$, that is, $E(\hat{\beta}) = \beta$, we obtain

$$d_1 = \beta - \hat{\beta}(\alpha/2) \quad \text{and} \quad d_2 = \hat{\beta}(1 - \alpha/2) - \beta$$

Therefore,

$$\begin{aligned} \hat{\beta}(\alpha/2) &= \beta - d_1 \\ \hat{\beta}(1 - \alpha/2) &= \beta + d_2 \end{aligned} \tag{15.24}$$

Substituting Eq. (15.24) into Eq. (15.23) produces

$$\beta - d_1 \leq \hat{\beta} \leq \beta + d_2$$

which can be written as

$$\begin{aligned} \beta - \beta - \hat{\beta} - d_1 &\leq \hat{\beta} - \beta - \hat{\beta} \leq \beta - \beta - \hat{\beta} + d_2 \\ -\hat{\beta} - d_1 &\leq -\beta \leq -\hat{\beta} + d_2 \\ \hat{\beta} - d_2 &\leq \beta \leq \hat{\beta} + d_1 \end{aligned}$$

this last equation is of the same form as the bootstrap confidence interval, Eq. (15.22), with D_1 and D_2 replacing d_1 , and d_2 and using $\hat{\beta}$ as an estimate of the mean of the sampling distribution.

We now present two examples. In the first example, standard methods are available for constructing the confidence interval, and our objective is to show that similar results are obtained by bootstrapping. The second example involves nonlinear regression, and the only confidence interval results available are based on asymptotic theory. We show how the bootstrap can be used to check the adequacy of the asymptotic results.

Example 15.3 The Delivery Time Data

The multiple regression version of these data, first introduced in Example 3.1 has been used several times throughout the book to illustrate various regression techniques. We will show how to obtain a bootstrap confidence interval for the regression coefficient for the predictor cases, β_1 . From Example 3.1, the least-squares estimate of β_1 is $\hat{\beta}_1 = 1.61591$. In Example 3.8 we found that the standard error of $\hat{\beta}_1$ is 0.17073, and the 95% confidence interval for β_1 is $1.26181 \leq \beta_1 \leq 1.97001$.

Since the model seems to fit the data well, and there is not a problem with inequality of variance, we will bootstrap residuals to obtain an approximate 95% bootstrap confidence interval for β_1 . Table 3.3 shows the fitted values and residuals for all 25 observations based on the original least-squares fit. To construct the first bootstrap sample, consider the first observation. The fitted value for this observation is $\hat{y}_1 = 21.7081$, from Table 3.3. Now select a residual at random from the last column of this table, say $e_5 = -0.4444$. This becomes the first bootstrap residual $e_1^* = -0.4444$. Then the first bootstrap observation becomes $y_1^* = y_1 + e_1^* = 21.7081 - 0.4444 = 21.2637$. Now we would repeat this process for each subsequent observation using the fitted values \hat{y}_i and the bootstrapped residuals e_i^* for $i = 2, 3, \dots, 25$ to construct the

remaining observations in the bootstrap sample. Remember that the residuals are sampled from the last column of Table 3.3 **with replacement**. After the bootstrap sample is complete, fit a linear regression model to the observations (x_{i1}, x_{i2}, y_i^*) , $i = 2, 3, \dots, 25$. The result from this yields the first bootstrap estimate of the regression coefficient, $\hat{\beta}_{1,1}^* = 1.64231$. We repeated this process $m = 1000$ times, producing 1000 bootstrap estimates $\hat{\beta}_{1,u}^*$, $u = 1, 2, \dots, 1000$. Figure 15.8 shows the histogram of these bootstrap estimates. Note that the shape of this histogram closely resembles the normal distribution. This is not unexpected, since the sampling distribution of $\hat{\beta}_1$ **should** be a normal distribution. Furthermore, the standard deviation of the 1000 bootstrap estimates is $s(\hat{\beta}_1^*) = 0.18994$, which is reasonably close to the usual normal-theory-based standard error of $\hat{\beta}_1$, $se(\hat{\beta}_1) = 0.17073$.

To construct the approximate 95% bootstrap confidence interval for $\hat{\beta}_1$, we need the 2.5th and 97.5th percentiles of the bootstrap sampling distribution. These quantities are $\hat{\beta}_1^*(0.025) = 1.24652$ and $\hat{\beta}_1^*(0.975) = 1.98970$, respectively (refer to Figure 15.8). The distances D_1 and D_2 are computed from Eq. (15.21) as follows:

$$D_1 = \hat{\beta}_1 - \hat{\beta}_1^*(0.025) = 1.61591 - 1.24652 = 0.36939$$

$$D_2 = \hat{\beta}_1^*(0.975) - \hat{\beta}_1 = 1.98970 - 1.61591 = 0.37379$$

Finally, the approximate 95% bootstrap confidence interval is obtained from Eq. (15.22).

$$\hat{\beta}_1 - D_2 \leq \beta_1 \leq \hat{\beta}_1 + D_1$$

$$1.61591 - 0.37379 \leq \beta_1 \leq 1.61591 + 0.36939$$

$$1.24212 \leq \beta_1 \leq 1.98530$$

This is very similar to the exact normal-theory confidence interval found in Example 3.8, $1.26181 \leq \beta_1 \leq 1.97001$. We would expect the two confidence intervals to closely agree, since there is no serious problem here with the usual regression assumptions. ■

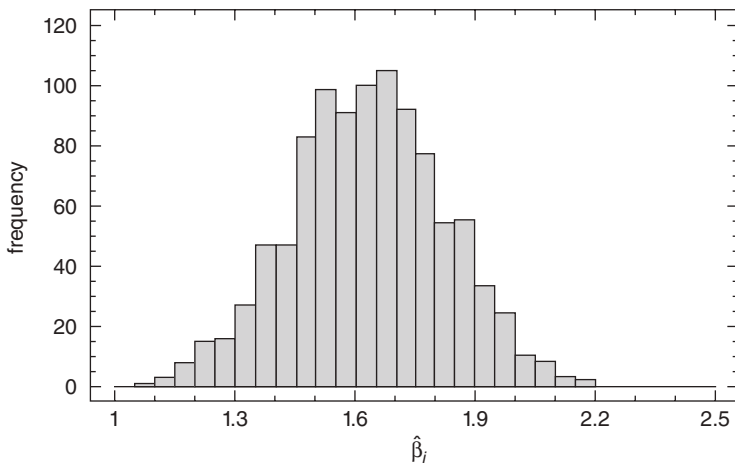

$$\bar{\beta}_1^* = 1.63166, S(\hat{\beta}_1^*) = 0.18994, \hat{\beta}_1^*(0.025) = 1.24652, \hat{\beta}_1^*(0.975) = 1.98970$$

Figure 15.8 Histogram of bootstrap $\hat{\beta}_1^*$, Example 15.3.

The most important applications of the bootstrap in regression are in situations either where there is no theory available on which to base statistical inference or where the procedures utilize large-sample or asymptotic results. For example, in nonlinear regression, all the statistical tests and confidence intervals are large-sample procedures and can only be viewed as approximate procedures. In a specific problem the bootstrap could be used to examine the validity of using these asymptotic procedures.

Example 15.4 The Puromycin data

Examples 12.2 and 12.3 introduced the puromycin data, and we fit the Michaelis-Menten model

$$y = \frac{\theta_1 x}{x + \theta_2} + \varepsilon$$

to the data in Table 12.1 which resulted in estimates of $\hat{\theta}_1 = 212.7$ and $\hat{\theta}_2 = 0.0641$, respectively. We also found the large-sample standard errors for these parameter estimates to be $\text{se}(\hat{\theta}_1) = 6.95$ and $\text{se}(\hat{\theta}_2) = 8.28 \times 10^{-3}$, and the approximate 95% confidence intervals were computed in Example 12.6 as

$$197.2 \leq \theta_1 \leq 228.2$$

and

$$0.0457 \leq \theta_2 \leq 0.0825$$

Since the inference procedures used here are based on large-sample theory, and the sample size used to fit the model is relatively small ($n = 12$), it would be useful to check the validity of applying the asymptotic results by computing bootstrap standard deviations and bootstrap confidence intervals for θ_1 and θ_2 . Since the Michaelis-Menten model seems to fit the data well, and there are no significant problems with inequality of variance, we used the approach of bootstrapping residuals to obtain 1000 bootstrap samples each of size $n = 12$. Histograms of the resulting bootstrap estimates of θ_1 and θ_2 are shown in Figures 15.9 and 15.10, respectively. The sample average, standard deviation, and 2.5th and 97.5th percentiles are also shown for each bootstrap distribution. Notice that the bootstrap averages and standard deviations are reasonably close to the values obtained from the original nonlinear least-squares fit. Furthermore, both histograms are reasonably normal in appearance, although the distribution for $\hat{\theta}_1^*$ may be slightly skewed.

We can calculate the approximate 95% confidence intervals for θ_1 and θ_2 . Consider first θ_1 . From Eq. (15.21) and the information in Figure 15.9 we find

$$\begin{aligned} D_1 &= \hat{\theta}_1 - \hat{\theta}_1^*(0.025) = 212.7 - 200.386 = 12.314 \\ D_2 &= \hat{\theta}_1^*(0.975) - \hat{\theta}_1 = 226.614 - 212.7 = 13.914 \end{aligned}$$

Therefore, the approximate 95% confidence interval is found from Eq. (15.22) as follows:

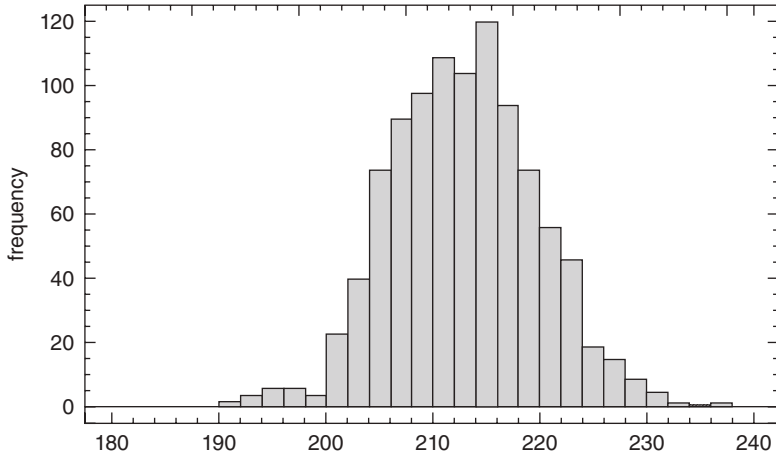

$\bar{\theta}_1^* = 212.88599, S(\hat{\theta}_1^*) = 6.87566, \hat{\theta}_1^*(0.025) = 200.386, \hat{\theta}_1^*(0.975) = 226.614$

Figure 15.9 Histogram of bootstrap estimates $\hat{\theta}_1^*$, Example 15.4.

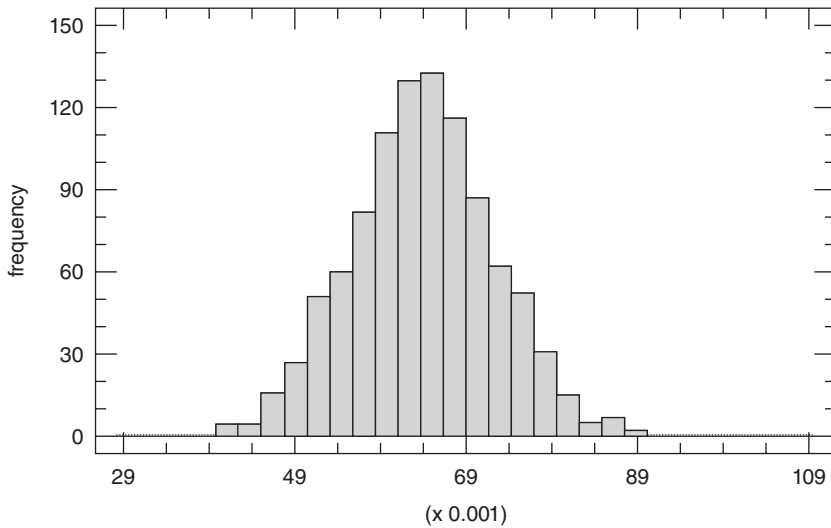

$\bar{\theta}_2^* = 0.06388, S(\hat{\theta}_2^*) = 0.00845, \hat{\theta}_2^*(0.025) = 0.04757, \hat{\theta}_2^*(0.975) = 0.08043$

Figure 15.10 Histogram of bootstrap estimates $\hat{\theta}_2^*$, Example 15.4.

$$\begin{aligned} \hat{\theta}_1 - D_2 &\leq \theta_1 \leq \hat{\theta}_1 + D_1 \\ 212.7 - 13.914 &\leq \theta_1 \leq 212.7 + 12.314 \\ 198.786 &\leq \theta_1 \leq 225.014 \end{aligned}$$

This is very close to the asymptotic normal-theory interval calculated in the original problem. Following a similar procedure we obtain the approximate 95% bootstrap confidence interval for θ_2 as

$$0.04777 \leq \theta_2 \leq 0.08063$$

Once again, this result is similar to the asymptotic normal-theory interval calculated in the original problem. This gives us some assurance that the asymptotic results apply, even though the sample size in this problem is only $n = 12$. ■

15.5 CLASSIFICATION AND REGRESSION TREES (CART)

The general classification problem can be stated as follows: given a response of interest and certain taxonomic data (measurement data or categorical descriptors) on a collection of units, use these data to predict the “class” into which each unit falls. The algorithm for accomplishing this task can then be used to make predictions about future units where the taxonomic data are known but the response is not. This is, of course, a very general problem, and many different statistical tools might be applied to it, including standard multiple regression, logistic regression or generalized linear models, cluster analysis, discriminant analysis, and so forth. In recent years, statisticians and computer scientists have developed **tree-based algorithms** for the classification problem. We give a brief introduction to these techniques in this section. For more details, see Breiman, Friedman, Olshen, and Stone [1984] and Gunter [1997a,b, 1998].

When the response variable is discrete, the procedure is usually called **classification**, and when it is continuous, the procedure leads to a **regression tree**. The usual acronym for the algorithms that perform these procedures is **CART**, which stands for **classification and regression trees**. A classification or regression tree is a hierarchical display of a series of questions about each unit in the sample. These questions relate to the values of the taxonomic data on each unit. When these questions are answered, we will know the “class” to which each unit most likely belongs. The usual display of this information is called a tree because it is logical to represent the questions as an upside-down tree with a root at the top, a series of branches connecting nodes, and leaves at the bottom. At each node, a question about one of the taxonomic variables is posed and the branch taken at the node depends on the answer. Determining the order in which the questions are asked is important, because it determines the structure of the tree. While there are many ways of doing this, the general principle is to ask the question that maximizes the gain in **node purity** at each node-splitting opportunity, where node purity is improved by minimizing the variability in the response data at the node. Thus, if the response is a discrete classification, higher purity would imply fewer classes or categories. A node containing a single class or category of the response would be completely pure. If the response is continuous, then a measure of variability such as a standard deviation, a mean square error, or a mean absolute deviation of the responses at a node should be made as small as possible to maximize node purity.

There are numerous specific algorithms for implementing these very general ideas, and many different computer software codes are available. CART techniques are often applied to very large or massive data sets, so they tend to be very computer intensive. There are many applications of CART techniques in situations ranging from interpretation of data from designed experiments to large-scale data exploration (often called data mining, or knowledge discovery in data bases).

Example 15.5 The Gasoline Mileage Data

Table B.3 presents gasoline mileage performance data on 32 automobiles, along with 11 taxonomic variables. There are missing values in two of the observations, so we will confine our analysis to only the 30 vehicles for which complete samples are available. Figure 15.11 presents a regression tree produced by S-PLUS applied to this data set. The bottom portion of the figure shows the descriptive information (also in hierarchical format) produced by S-PLUS for each node in the tree. The measure of node purity or **deviance** at each node is just the corrected sum of squares of the observations at that node, **yval** is the average of these observations, and *n* refers to the number of observations at the node.

At the root node, we have all 30 cars, and the deviance there is just the corrected sum of squares of all 30 cars. The average mileage in the sample is 20.04 mpg. The first branch is on the variable CID, or cubic inches of engine displacement. There are four cars in node 2 that have a CID below 115.25, their deviance is 22.55, and the average mileage performance is 33.38 mpg. The deviance in node 3 from the right-hand branch of the root node is 295.6 and the sum of the deviances from nodes 2 and 3 is 318.15. There are no other splits possible at any level on any variable to classify the observations that will result in a lower sum of deviances than 318.15.

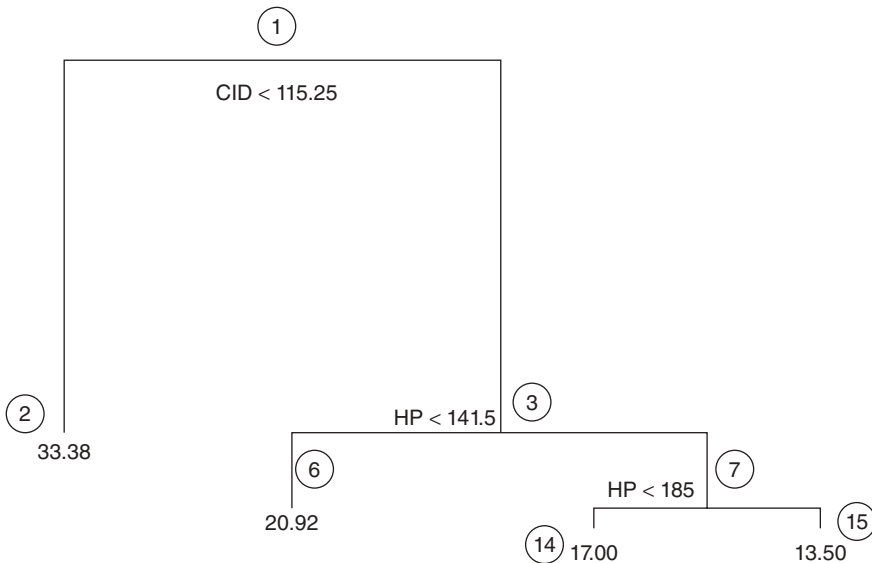

```

dc), split, n, deviance, yval
* denotes terminal node
1) root 30 1139.0000 20.04
2) CID < 115.25 4 22.5500 33.38 *
3) CID > 115.25 295.6000 17.99
6) HP < 141.5 11 32.4200 20.92 *
7) HP > 141.5 11 99.0400 15.83
14) HP < 185 10 50.1600 17.00 *
15) HP > 185.5 8.1400 13.50 *
    
```

Figure 15.11 CART analysis from S-PLUS for the gasoline mileage data from Table B.3.

Node 2 is a **terminal node** because the node deviance is a smaller percentage of the root node deviance than the user specified allowance. Terminal nodes can also occur if there are not enough observations (again, user specified) to split the node. So, at this point, if one wishes to identify cars in the highest-mileage performance group, all we need to look at is engine displacement.

Node 3 contains 26 cars, and it is subsequently split at the next node by horsepower. Eleven cars with horsepower below 141.5 form one branch from this node, while 15 cars with horsepower above 141.5 form the other branch. The left-hand branch results in the terminal node 6. The right-hand branch enters another node (7) which is branched again on horsepower. This illustrates an important feature of regression trees; the same question can be asked more than once at different nodes of the tree, reflecting the complexity of the interrelationships among the variables in the problem. Nodes 14 and 15 are terminal nodes, and the cars in both terminal nodes have similar mileage performance.

The tree indicates that we may be able to classify cars into higher-mileage, medium-mileage, and lower-mileage classifications by examining CID and horsepower—only 2 of the 11 taxonomic variables given in the original data set. For purposes of comparison, forward variable selection using mpg as the response would choose CID as the only important variable, and either stepwise regression or backward elimination would select rear axle ratio, length, and weight. However, remember that the objectives of CART and multiple regression are somewhat different: one is trying to find an optimal (or near-optimal) classification structure, while the other seeks to develop a prediction equation. ■

15.6 NEURAL NETWORKS

Neural networks, or more accurately **artificial neural networks**, have been motivated by the recognition that the human brain processes information in a way that is fundamentally different from the typical digital computer. The neuron is the basic structural element and information-processing module of the brain. A typical human brain has an enormous number of them (approximately 10 billion neurons in the cortex and 60 trillion synapses or connections between them) arranged in a highly complex, nonlinear, and parallel structure. Consequently, the human brain is a very efficient structure for information processing, learning, and reasoning.

An artificial neural network is a structure that is designed to solve certain types of problems by attempting to emulate the way the human brain would solve the problem. The general form of a neural network is a “black-box” type of model that is often used to model high-dimensional, nonlinear data. Typically, most neural networks are used to solve prediction problems for some system, as opposed to formal model building or development of underlying knowledge of how the system works. For example, a computer company might want to develop a procedure for automatically reading handwriting and converting it to typescript. If the procedure can do this quickly and accurately, the company may have little interest in the specific model used to do it.

Multilayer feedforward artificial neural networks are multivariate statistical models used to relate p predictor variables x_1, x_2, \dots, x_p to q response variables $y_1,$

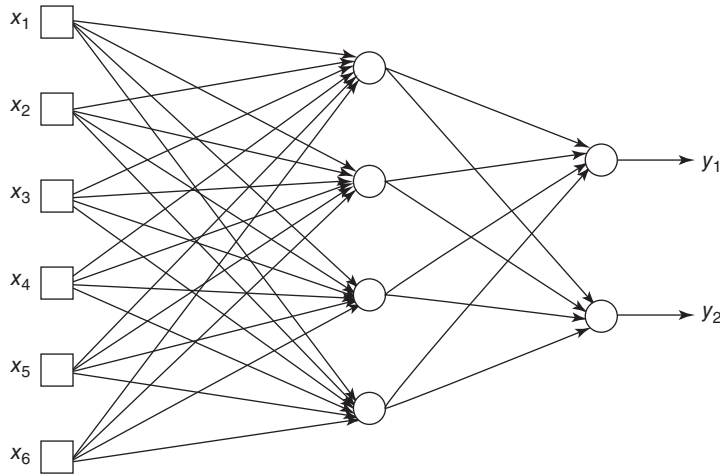

Figure 15.12 Artificial neural network with one hidden layer.

y_2, \dots, y_q . The model has several **layers**, each consisting of either the original or some constructed variables. The most common structure involves three layers: the **inputs**, which are the original predictors; the **hidden layer**, comprised of a set of constructed variables; and the output layer, made up of the responses. Each variable in a layer is called a **node**. Figure 15.12 shows a typical three-layer artificial neural network.

A node takes as its input a transformed linear combination of the outputs from the nodes in the layer below it. Then it sends as an output a transformation of itself that becomes one of the inputs, to one or more nodes on the next layer. The transformation functions are usually either sigmoidal (S shaped) or linear and are usually called **activation functions** or **transfer functions**. Let each of the k hidden layer nodes a_u be a linear combination of the input variables:

$$a_u = \sum_{j=1}^p w_{1ju} x_j + \theta_u$$

where the w_{1ju} are unknown parameters that must be estimated (called weights) and θ_u is a parameter that plays the role of an intercept in linear regression (this parameter is sometimes called the bias node).

Each node is transformed by the activation function $g(\cdot)$. Much of the neural networks literature refers to these activation functions notationally as $\sigma(\cdot)$ because of their S shape (this is an unfortunate choice of notation so far as statisticians are concerned). Let the output of node a_u be denoted by $Z_u = g(a_u)$. Now we form a linear combination of these outputs, say $b_v = \sum_{u=0}^k w_{2uv} z_u$, where $z_0 = 1$. Finally, the v th response y is a transformation of the b , say $y_v = \tilde{g}(b_v)$, where $\tilde{g}(\cdot)$ is the activation function for the response. This can all be combined to give

$$y_v = \tilde{g} \left[\sum_{u=1}^k w_{2uv} g \left(\sum_{j=1}^p w_{1ju} x_j + \theta_{1j} \right) + \theta_{2u} \right] \quad (15.25)$$

The response y_v is a transformed linear combination of transformed linear combinations of the original predictors. For the hidden layer, the activation function is often chosen to be either the logistic function $g(x) = 1/(1 + e^{-x})$ or the hyperbolic tangent function $g(x) = \tanh(x) = (e^x - e^{-x})/(e^x + e^{-x})$. The choice of activation function for the output layer depends on the nature of the response. If the response is bounded or dichotomous, the output activation function is usually taken to be sigmoidal, while if it is continuous, an identify function is often used.

The model in Eq. (15.25) is a very flexible form containing many parameters, and it is this feature that gives a neural network a nearly universal approximation property. That is, it will fit many naturally occurring functions. However, the parameters in Eq. (15.25) must be estimated, and there are a lot of them. The usual approach is to estimate the parameters by minimizing the overall residual sum of squares taken over all responses and all observations. This is a nonlinear least-squares problem, and a variety of algorithms can be used to solve it. Often a procedure called **backpropagation** (which is a variation of steepest descent) is used, although derivative-based gradient methods have also been employed. As in any nonlinear estimation procedure, starting values for the parameters must be specified in order to use these algorithms. It is customary to standardize all the input variables, so small essentially random values are chosen for the starting values.

With so many parameters involved in a complex nonlinear function, there is considerable danger of **overfitting**. That is, a neural network will provide a nearly perfect fit to a set of historical or “training” data, but it will often predict new data very poorly. Overfitting is a familiar problem to statisticians trained in empirical model building. The neural network community has developed various methods for dealing with this problem, such as reducing the number of unknown parameters (this is called “optimal brain surgery”), stopping the parameter estimation process before complete convergence and using cross-validation to determine the number of iterations to use, and adding a penalty function to the residual sum of squares that increases as a function of the sum of the squares of the parameter estimates. There are also many different strategies for choosing the number of layers and number of neurons and the form of the activation functions. This is usually referred to as choosing the **network architecture**. Cross-validation can be used to select the number of nodes in the hidden layer. Good references on artificial neural networks are Bishop [1995], Haykin [1994], and Ripley [1994].

Artificial neural networks are an active area of research and application, particularly for the analysis of large, complex, highly nonlinear problems. The overfitting issue is frequently overlooked by many users and advocates of neural networks, and because many members of the neural network community do not have sound training in empirical model building, they often do not appreciate the difficulties overfitting may cause. Furthermore, many computer programs for implementing neural networks do not handle the overfitting problem particularly well. Our view is that neural networks are a complement to the familiar statistical tools of regression analysis and designed experiments and not a replacement for them, because a neural

network can only give a prediction model and not fundamental insight into the underlying process mechanism that produced the data.

15.7 DESIGNED EXPERIMENTS FOR REGRESSION

Many properties of the fitted regression model depend on the levels of the predictor variables. For example, the $\mathbf{X}'\mathbf{X}$ matrix determines the variances and covariances of the model regression coefficients. Consequently, in situations where the levels of the x 's can be chosen it is natural to consider the problem of **experimental design**. That is, if we can choose the levels of each of the predictor variables (and even the number of observations to use), how should we go about this? We have already seen an example of this in Chapter 5 on fitting polynomials where a central composite design was used to fit a second-order polynomial in two variables. Because many problems in engineering, business, and the sciences use low-order polynomial models (typically first-order and second-order polynomials) in their solution there is an extensive literature on experimental designs for fitting these models. For example, see the book on experimental design by Montgomery (2009) and the book on response surface methodology by Myers, Montgomery, and Anderson-Cook (2009). This section gives an overview of designed experiments for regression models and some useful references.

Suppose that we want to fit a first-order polynomial in three variables, say,

$$y = \beta_0 + \beta_1 x_1 + \beta_2 x_2 + \beta_3 x_3 + \varepsilon$$

and we can specify the levels of the three regressor variables. Assume that the regressor variables are continuous and can be varied over the range from -1 to $+1$; that is, $-1 \leq x_i \leq +1$, $i = 1, 2, 3$. **Factorial designs** are very useful for fitting regression models. By a factorial design we mean that every possible level of a factor is run in combination with every possible level of all other factors. For example, suppose that we want to run each of the regressor variables at two levels, -1 and $+1$. Then the factorial design is called a 2^3 factorial design and it has $n = 8$ runs. The design matrix \mathbf{D} is just an 8×3 matrix containing the levels of the regressors:

$$\mathbf{D} = \begin{bmatrix} -1 & -1 & -1 \\ 1 & -1 & -1 \\ -1 & 1 & -1 \\ 1 & 1 & -1 \\ -1 & -1 & 1 \\ 1 & -1 & 1 \\ -1 & 1 & 1 \\ 1 & 1 & 1 \end{bmatrix}$$

The \mathbf{X} matrix (or model matrix) is

$$\mathbf{X} = \begin{bmatrix} 1 & -1 & -1 & -1 \\ 1 & 1 & -1 & -1 \\ 1 & -1 & 1 & -1 \\ 1 & 1 & 1 & -1 \\ 1 & -1 & -1 & 1 \\ 1 & 1 & -1 & 1 \\ 1 & -1 & 1 & 1 \\ 1 & 1 & 1 & 1 \end{bmatrix}$$

and the $\mathbf{X}'\mathbf{X}$ matrix is

$$\mathbf{X}'\mathbf{X} = \begin{bmatrix} 8 & 0 & 0 & 0 \\ 0 & 8 & 0 & 0 \\ 0 & 0 & 8 & 0 \\ 0 & 0 & 0 & 8 \end{bmatrix}$$

Notice that the $\mathbf{X}'\mathbf{X}$ matrix is diagonal, indicating that the 2^3 factorial design is **orthogonal**. The variance of any regression coefficient is

$$\text{Var}(\hat{\beta}) = \frac{\sigma^2}{8}$$

Furthermore, there is no other eight-run design on the design space bounded by ± 1 that would make the variance of the model regression coefficients smaller.

For the 2^3 design, the determinant of the $\mathbf{X}'\mathbf{X}$ matrix is $|\mathbf{X}'\mathbf{X}| = 4096$. This is the maximum possible value of the determinant for an eight-run design on the design space bounded by ± 1 . It turns out that the volume of the joint confidence region that contains all the model regression coefficients is inversely proportional to the square root of the determinant of $\mathbf{X}'\mathbf{X}$. Therefore, to make this joint confidence region as small as possible, we would want to choose a design that makes the determinant of $\mathbf{X}'\mathbf{X}$ as large as possible. This is accomplished by choosing the 2^3 design.

These results generalize to the case of a first-order model in k variables, or a first-order model with interaction. A 2^k factorial design (i.e., a factorial design with all k factors at two levels (± 1)) will minimize the variance of the regression coefficients and minimize the volume of the joint confidence region on all of the model parameters. A design with this property is called a **D-optimal design**. Optimal designs resulted from the work of Kiefer (1959, 1961) and Kiefer and Wolfowitz (1959). Their work is couched in a measure theoretic framework in which an experimental design is viewed in terms of design measure. Design optimality moved into the practical arena in the 1970s and 1980s as designs were put forth as being **efficient** in terms of criteria inspired by Kiefer and his coworkers. Computer algorithms were developed that allowed “optimal” designs to be generated by a computer package

based on the practitioner's choice of sample size, model, ranges on variables, and other constraints.

Now consider the variance of the predicted response for the first-order model in the 2^3 design

$$\begin{aligned} \text{Var}[\hat{y}(x_1, x_2, x_3)] &= \text{Var}(\hat{\beta}_0 + \hat{\beta}_1 x_1 + \hat{\beta}_2 x_2 + \hat{\beta}_3 x_3) \\ &= \frac{\sigma^2}{8}(1 + x_1^2 + x_2^2 + x_3^2) \end{aligned}$$

The variance of the predicted response is a function of the point in the design space where the prediction is made (x_1 , x_2 , and x_3) and the variance of the model regression coefficients. The estimates of the regression coefficients are independent because the 2^3 design is orthogonal and the model parameters all have variance $\sigma^2/8$. Therefore, the maximum prediction variance occurs when $x_1 = x_2 = x_3 = \pm 1$ and is equal to $\sigma^2/2$.

To determine how good this is, we need to know the best possible value of prediction variance that can be attained. It turns out that the smallest possible value of the maximum prediction variance over the design space is $p\sigma^2/n$, where p is the number of model parameters and n is the number of runs in the design. The 2^3 design has $n = 8$ runs and the model has $p = 4$ parameters, so the model that we fit to the data from this experiment minimizes the maximum prediction variance over the design region. A design that has this property is called a **G-optimal design**. In general, 2^k designs are G-optimal designs for fitting the first-order model or the first-order model with interaction.

We can evaluate the prediction variance at any point of interest in the design space. For example, when we are at the center of the design where $x_1 = x_2 = x_3 = 0$, the prediction variance is

$$\text{Var}[\hat{y}(x_1 = 0, x_2 = 0, x_3 = 0)] = \text{Var}(\hat{\beta}_0) = \frac{\sigma^2}{8}$$

and when $x_1 = 1, x_2 = x_3 = 0$, the prediction variance is

$$\text{Var}[\hat{y}(x_1 = 1, x_2 = 0, x_3 = 0)] = \text{Var}(\hat{\beta}_0 + \hat{\beta}_1) = \frac{\sigma^2}{4}$$

The average prediction variance at these two points is

$$\frac{1}{2} \left(\frac{\sigma^2}{8} + \frac{\sigma^2}{4} \right) = \frac{3\sigma^2}{16}.$$

A design that minimizes the average prediction variance over a selected set of points is called a **V-optimal design**.

An alternative to averaging the prediction variance over a specific set of points in the design space is to consider the **average prediction variance** over the entire

design space. One way to calculate this average prediction variance or the **integrated variance** is

$$I = \frac{1}{A} \int_R \text{Var}[\hat{y}(\mathbf{x})] d\mathbf{x}$$

where A is the area or volume of the design space and R is the design region. To compute the average, we are integrating the variance function over the design space and dividing by the area or volume of the region. Now for a 2^3 design, the volume of the design region is 8, and the integrated variance is

$$I = \sigma^2 \frac{1}{8} \int_{-1}^1 \int_{-1}^1 \int_{-1}^1 (1 + x_1^2 + x_2^2 + x_3^2) dx_1 dx_2 dx_3 = 0.25\sigma^2$$

It turns out that this is the smallest possible value of the average prediction variance that can be obtained from an eight-run design used to fit a first-order model on this design space. A design with this property is called an **I-optimal design**. In general, 2^k designs are *I*-optimal designs for fitting the first-order model or the first-order model with interaction.

Now consider designs for fitting second-order polynomials. As we noted in Chapter 7, second-order polynomial models are widely used in industry in the application of **response surface methodology** (RSM), a collection of experimental design, model fitting, and optimization techniques that are widely used in process improvement and optimization. The second-order polynomial in k factors is

$$y = \beta_0 + \sum_{i=1}^k \beta_i x_i + \sum_{i=1}^k \beta_{ii} x_i^2 + \sum_{i < j=2}^k \beta_{ij} x_i x_j + \varepsilon_i.$$

This model has $1 + 2k + k(k - 1)/2$ parameters, so the design must contain at least this many runs. In Section 7.4 we illustrated designing an experiment to fit a second-order model in $k = 2$ factors and the associated model fitting and analysis typical of most RSM studies.

There are a number of standard designs for fitting second-order models. The two most widely used designs are the **central composite design** and the **Box-Behnken** design. The central composite design was used in Section 7.4. A central composite design consists of a 2^k factorial design (or a fractional factorial that will allow estimation of all of the second-order model terms), $2k$ axial runs, defined as follows:

x_1	x_2	...	x_k
$-\alpha$	0	...	0
α	0	...	0
0	$-\alpha$...	0
0	α	...	0
\vdots	\vdots		\vdots
0	0	...	$-\alpha$
0	0	...	α

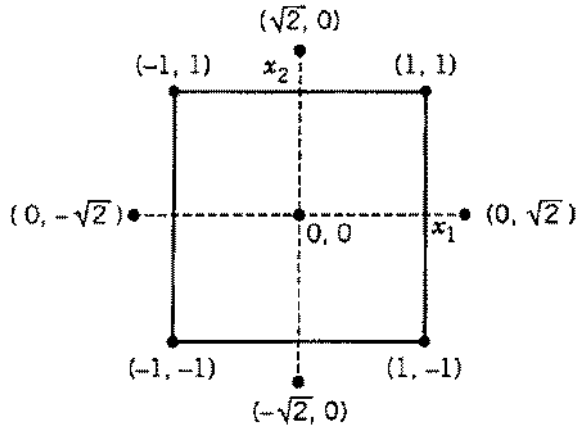

Figure 15.13 The central composite design for $k = 2$ and $\alpha = \sqrt{k} = \sqrt{2}$.

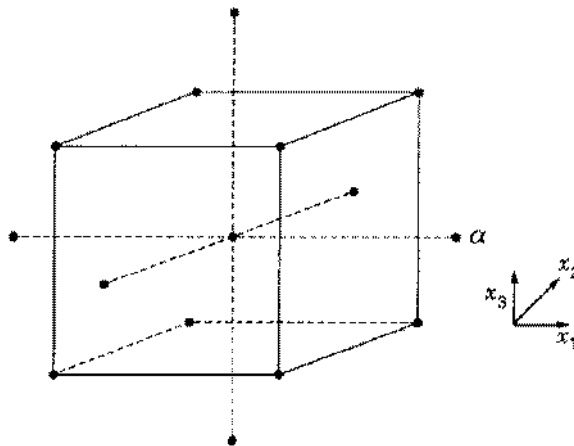

Figure 15.14 The central composite design for $k = 3$ and $\alpha = \sqrt{k} = \sqrt{3}$.

and n_C center runs at $x_1 = x_2 = \dots = x_k = 0$. There is considerable flexibility in the use of the central composite design because the experimenter can choose both the axial distance α and the number of center runs. The choice of these two parameters can be very important. Figures 15.13 and 15.14 show the CCD for $k = 2$ and $k = 3$. The value of the axial distance generally varies from 1.0 to \sqrt{k} , the former placing all of the axial points on the face of the cube or hypercube producing a design on a **cuboidal** region, the latter resulting in all points being equidistant from the design center producing a design on a **spherical** region. When $\alpha = 1$ the central composite design is usually called a **face-centered cube** design. As we observed in Section 7.4, when the axial distance $\alpha = \sqrt[4]{F}$, where F is the number of factorial design points, the central composite design is **rotatable**; that is, the variance of the predicted response $Var[\hat{y}(\mathbf{x})]$ is constant for all points that are the same distance from the design center. Rotatability is a desirable property when the model fit to the data from the design is going to be used for optimization. It ensures that the variance of the predicted

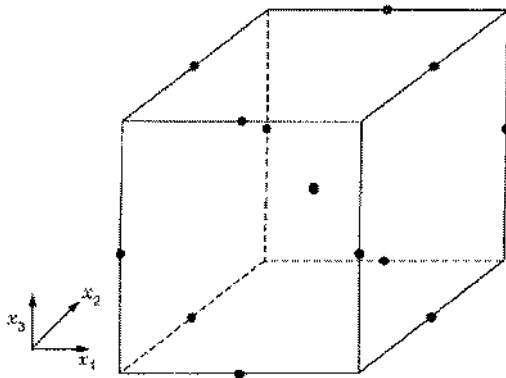

Figure 15.15 The Box–Behnken design for $k = 3$ factors with one center point.

response depends only on the distance of the point of interest from the design center and not on the direction. Both the central composite design and the Box–Behnken design also perform reasonably well relative to the D -optimality and I -optimality criteria.

The Box–Behnken design is also a spherical design that is either rotatable or approximately rotatable. The Box–Behnken design for $k = 3$ factors is shown in Figure 15.15. All of the points in this design are on the surface of a sphere of radius $\sqrt{2}$. Refer to Montgomery (2009) or Myers, Montgomery, and Anderson-Cook (2009) for additional details of central composite and Box–Behnken designs as well as information on other standard designs for fitting the second-order polynomial model.

The JMP software will construct D -optimal and I -optimal designs. The approach used is based on a coordinate exchange algorithm developed by Meyer and Nachtsheim (1995). The experimenter specifies the number of factors, the model that is to be fit, the number of runs in the design, any constraints or restrictions on the design region, and the optimality criterion to be used (D or I). The coordinate exchange technique begins with a randomly chosen design and then systematically searches over each coordinate of each run to find a setting for that coordinate that produces the best value of the criterion. When the search is completed on the last run, it begins again with the first coordinate of the first run. This is continued until no further improvement in the criterion can be made. Now it is possible that the design found by this method is not optimal because it may depend on the random starting design, so another random design is created and the coordinate exchange process repeated. After several random starts the best design found is declared optimal. This algorithm is extremely efficient and usually produces optimal or very near optimal designs.

To illustrate the construction of optimal designs suppose that we want to run an experiment to fit a second-order model in $k = 4$ factors. The region of interest is cuboidal and all four factors are defined to be in the interval from -1 to $+1$. This model has $p = 15$ parameters, so the design must have at least 15 runs. The central composite design in $k = 4$ factors has between 25 and 30 runs, depending on the number of center points. This is a relatively large design in comparison to the number of parameters that must be estimated. A fairly typical use of optimal designs

TABLE 15.5 An 18 Run D -Optimal Design for a Second-Order Model in $k = 4$ Factors

Run	X1	X2	X3	X4
1	0	0	1	0
2	1	1	1	-1
3	-1	-1	1	1
4	1	1	-1	1
5	-1	1	1	1
6	-1	-1	1	-1
7	1	-1	1	-1
8	1	-1	1	1
9	0	1	-1	-1
10	1	0	-1	-1
11	-1	0	-1	1
12	-1	1	1	-1
13	-1	-1	-1	-1
14	0	1	0	1
15	-1	0	0	-1
16	1	-1	0	0
17	-1	1	-1	0
18	0	-1	-1	1

is to create a custom design in situations where resources do not permit using the number of runs associated with a standard design. We will construct optimal designs with 18 runs. The 18-run D -optimal design constructed using JMP is shown in Table 15.5, and the I -optimal design is shown in Table 15.6. Both of these designs look somewhat similar. JMP reports the D -efficiency of the design in Table 15.5 as 44.98232% and the D -efficiency of the design in Table 15.6 as 39.91903%. Note that the D -optimal design algorithm did not produce a design with 100% D -efficiency, because the D -efficiency is computed relative to a “theoretical” orthogonal design that may not exist. The G -efficiency for the design in Table 15.5 is 75.38478% and for the design in Table 15.6 it is 73.57805%. The G -efficiency of a design is easy to calculate, because as we observed earlier the theoretical minimum value of the maximum value of the scaled prediction variance over the design space design space is $p\sigma^2/n$, where p is the number of model parameters and n is the number of runs in the design, so all we have to do is find the actual maximum value of the prediction variance, and the G -efficiency can be calculated from

$$G_{\text{Efficiency}} = \frac{p}{\text{Max} \left\{ \frac{n \text{Var}[\hat{y}(\mathbf{x})]}{\sigma^2} \right\}}$$

Typically, efficiencies are reported on a percentage basis. Both designs have very similar G -efficiencies. JMP also reports the average (integrated) prediction variance over the design space as $0.652794 \sigma^2$ for the D -optimal design and $0.48553 \sigma^2$ for the I -optimal design. It is not surprising that the integrated variance is smaller for the I -optimal design as it was constructed to minimize this quantity.

TABLE 15.6 An 18 Run *I*-Optimal Design for a Second-Order Model in $k = 4$ Factors

Run	X1	X2	X3	X4
1	1	0	1	1
2	-1	-1	1	1
3	-1	-1	0	-1
4	1	1	1	-1
5	0	-1	1	-1
6	-1	1	1	0
7	1	-1	-1	1
8	1	-1	-1	-1
9	0	1	0	1
10	-1	1	-1	-1
11	0	0	0	0
12	0	0	0	0
13	-1	0	-1	1
14	1	-1	0	0
15	-1	0	1	-1
16	0	-1	-1	0
17	1	1	-1	0
18	0	0	0	-1

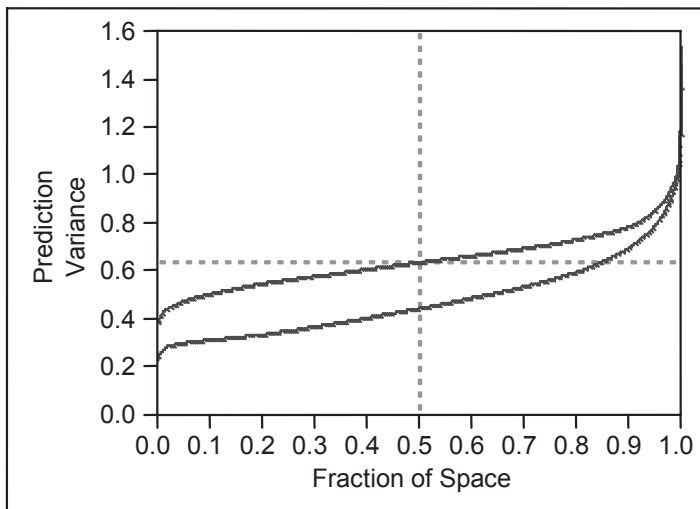

Figure 15.16 Fraction of design space plot for the *D*-optimal and *I*-optimal designs in Tables 15.5 and 15.6.

To further compare these two designs, consider the graph in Figure 15.16. This is a fraction of design space (FDS) plot. For any value of prediction variance on the vertical scale the curve shows the fraction or proportion of the total design space in which the prediction variance is less than or equal to the vertical scale value. An “ideal” design would have a low, flat curve on the FDS plot. The lower curve in Figure 15.16 is the *I*-optimal design and the upper curve is for the *D*-optimal

design. Obviously, the I -optimal design outperforms the D -optimal design in terms of prediction variance over almost all of the design space. It does have a lower G -efficiency, indicating that there is a very small portion of the design space where the maximum prediction variance for the D -optimal design is less than the prediction variance for the I -optimal design. That point is at the extreme end of the region.

PROBLEMS

15.1 Explain why an estimator with a breakdown point of 50% may not give satisfactory results in fitting a regression model.

15.2 Consider the continuous probability distribution $f(x)$. Suppose that θ is an unknown location parameter and that the density may be written as $f(x - \theta)$ for $-\infty < \theta < \infty$. Let x_1, x_2, \dots, x_n be a random sample of size n from the density.

a. Show that the maximum-likelihood estimator of θ is the solution to

$$\sum_{i=1}^n \psi(x_i - \theta) = 0$$

that maximizes the logarithm of the likelihood function $L(\mu) = \sum_{i=1}^n \ln f(x_i - \theta)$, where $\psi(x) = \rho'(x)$ and $\rho(x) = -\ln f(x)$.

b. If $f(x)$ is a normal distribution, find $\rho(x)$, $\psi(x)$ and the corresponding maximum-likelihood estimator of θ .

c. If $f(x) = (2\sigma)^{-1}e^{-|x|/\sigma}$ (the double-exponential distribution), find $\rho(x)$ and $\psi(x)$. Show that the maximum-likelihood estimator of θ is the sample median. Compare this estimator with the estimator found in part b. Does the sample median seem to be a reasonable estimator in this case?

d. If $f(x) = [\pi(1+x^2)]^{-1}$ (the Cauchy distribution), find $\rho(x)$ and $\psi(x)$. How would you solve $\sum_{i=1}^n \psi(x_i - \theta)$ in this case?

15.3 **Tukey's Biweight.** A popular ψ function for robust regression is Tukey's biweight, where

$$\psi(z) = \begin{cases} z[1 - (z/a)^2]^2, & |z| \leq a \\ 0, & |z| > a \end{cases}$$

with $a = 5, 6$ Sketch the ψ function for $a = 5$ and discuss its behavior. Do you think that Tukey's biweight would give results similar to Andrews' wave function?

15.4 The U.S. Air Force uses regression models for cost estimating, an application that almost always involves outliers. Simpson and Montgomery [1998a] present 19 observations on first-unit satellite cost data (y) and the weight of the electronics suite (x). The data are shown in the following table.

Observation	Cost (\$K)	Weight (lb)
1	2449	90.6
2	2248	87.8
3	3545	38.6
4	794	28.6
5	1619	28.9
6	2079	23.3
7	918	21.1
8	1231	17.5
9	3641	27.6
10	4314	39.2
11	2628	34.9
12	3989	46.6
13	2308	80.9
14	376	14.6
15	5428	48.1
16	2786	38.1
17	2497	73.2
18	5551	40.8
19	5208	44.6

- a. Draw a scatter diagram of the data. Discuss what types of outliers may be present.
 - b. Fit a straight line to these data with OLS. Does this fit seem satisfactory?
 - c. Fit a straight line to these data with an M -estimator of your choice. Is the fit satisfactory? Discuss why the M -estimator is a poor choice for this problem.
 - d. Discuss the types of estimators that you think might be appropriate for this data set.
- 15.5** Table B.14 presents data on the transient points of an electronic inverter. Fit a model to those data using an M -estimator. Is there an indication that observations might have been incorrectly recorded?
- 15.6** Consider the regression model in Problem 2.10 relating systolic blood pressure to weight. Suppose that we wish to predict an individual's weight given an observed value of systolic blood pressure. Can this be done using the procedure for predicting x given a value of y described in Section 15.3? In this particular application, how would you respond to the suggestion of building a regression model relating weight to systolic blood pressure?
- 15.7** Consider the regression model in Problem 2.4 relating gasoline mileage to engine displacement.
- a. If a particular car has an observed gasoline mileage of 17 miles per gallon, find a point estimate of the corresponding engine displacement.
 - b. Find a 95% confidence interval on engine displacement.

- 15.8** Consider a regression model relating total heat flux to radial deflection for the solar energy data in Table B.2.
- Suppose that the observed total heat flux is 250 kW. Find a point estimate of the corresponding radial deflection.
 - Construct a 90% confidence interval on radial deflection.
- 15.9** Consider the soft drink delivery time data in Example 3.1. Find an approximate 95% bootstrap confidence interval on the regression coefficient for distance using $m = 1000$ bootstrap samples. Compare this to the usual normal-theory confidence interval.
- 15.10** Consider the soft drink delivery time data in Example 3.1. Find the bootstrap estimate of the standard deviation of $\hat{\beta}_1$ using the following numbers of bootstrap samples: $m = 100$, $m = 200$, $m = 300$, $m = 400$, and $m = 500$. Can you draw any conclusions about how many bootstrap samples are necessary to obtain a reliable estimate of the precision of estimation for $\hat{\beta}_1$?
- 15.11** Describe how you would find a bootstrap estimate of the standard deviation of the estimate of the mean response at a particular point, say \mathbf{x}_0 .
- 15.12** Describe how you would find an approximate bootstrap confidence interval on the mean response at a particular point, say \mathbf{x}_0 .
- 15.13** Consider the nonlinear regression model fit to the data in Problem 12.11. Find the bootstrap standard errors for the regression coefficients $\hat{\theta}_1$, $\hat{\theta}_2$, and $\hat{\theta}_3$ using $m = 1000$ bootstrap samples. Based on the results you obtain, comment on how the asymptotic theory seems to apply to this problem.
- 15.14** Consider the nonlinear regression model fit to the data in Problem 12.11. Find approximate 95% bootstrap confidence intervals for the regression coefficients $\hat{\theta}_1$, $\hat{\theta}_2$, and $\hat{\theta}_3$ using $m = 1000$ bootstrap samples. Compare these intervals to the ones based on the large-sample results. Based on the comparison of these intervals, comment on how the asymptotic theory seems to apply to this problem.
- 15.15** Consider the NFL team performance data in Table B.1. Construct a regression tree for this data set.
- 15.16** **A Designed Experiment for Linear Regression.** You wish to fit a simple linear regression model over the region $-1 \leq x \leq 1$ using $n = 10$ observations. Four experimental designs are under consideration: (i) 5 observations at $x = -1$ and 5 observations at $x = +1$, (ii) 4 observations at $x = -1$, 2 observations at $x = 0$, and 4 observations at $x = +1$, (iii) 2 observations at $x = -1$, $-\frac{1}{2}$, 0 , $+\frac{1}{2}$, and $+1$, and (iv) 1 observation at $x = -1$, -0.8 , -0.6 , -0.4 , -0.2 , $+0.2$, $+0.4$, $+0.6$, $+0.8$, and $+1$. For each of these designs, find the number of degrees of freedom available for evaluating pure error and testing lack of fit, the standard error of the slope (up to a constant σ), and the value of the determinant of $\mathbf{X}'\mathbf{X}$. Based on these analyses, which design would you select?
- 15.17** An analyst is fitting a simple linear regression model with the objective of obtaining a minimum-variance estimate of the intercept β_0 . How should the data collection experiment be designed?

- 15.18** Suppose that you are fitting a simple linear regression model that will be used to predict the mean response at a particular point such as x_0 . How should the data collection experiment be designed so that a minimum-variance estimate of the mean of y at x_0 is obtained?
- 15.19** Consider the linear regression model $y = \beta_0 + \beta_1 x_1 + \beta_2 x_2 + \varepsilon$, where the regressors have been coded so that

$$\sum_{i=1}^n x_{i1} = \sum_{i=1}^n x_{i2} = 0 \quad \text{and} \quad \sum_{i=1}^n x_{i1}^2 = \sum_{i=1}^n x_{i2}^2 = n$$

- a.** Show that an orthogonal design ($\mathbf{X}'\mathbf{X}$ diagonal) minimizes the variance of $\hat{\beta}_1$ and $\hat{\beta}_2$.
- b.** Show that any design for fitting this first-order model that is orthogonal is also rotatable.

APPENDIX A

STATISTICAL TABLES

- Table A.1** Cumulative Standard Normal Distribution
- Table A.2** Percentage Points of the χ^2 Distribution
- Table A.3** Percentage Points of the t Distribution
- Table A.4** Percentage Points of the F Distribution
- Table A.5** Orthogonal Polynomials
- Table A.6** Critical Values of the Durbin–Watson Statistic

TABLE A.1 Cumulative Standard Normal Distribution

$$\Phi(z) = \int_{-\infty}^z \frac{1}{\sqrt{2\pi}} e^{-u^2/2} du$$

<i>z</i>	.00	.01	.02	.03	.04	<i>z</i>
.0	.50000	.50399	.50798	.51197	.51595	.0
.1	.53983	.54379	.54776	.55172	.55567	.1
.2	.57926	.58317	.58706	.59095	.59483	.2
.3	.61791	.62172	.62551	.62930	.63307	.3
.4	.65542	.65910	.66276	.66640	.67003	.4
.5	.69146	.69497	.69847	.70194	.70540	.5
.6	.72575	.72907	.73237	.73565	.73891	.6
.7	.75803	.76115	.76424	.76730	.77035	.7
.8	.78814	.79103	.79389	.79673	.79954	.8
.9	.81594	.81859	.82121	.82381	.82639	.9
1.0	.84134	.84375	.84613	.84849	.85083	1.0
1.1	.86433	.86650	.86864	.87076	.87285	1.1
1.2	.88493	.88686	.88877	.89065	.89251	1.2
1.3	.90320	.90490	.90658	.90824	.90988	1.3
1.4	.91924	.92073	.92219	.92364	.92506	1.4
1.5	.93319	.93448	.93574	.93699	.93822	1.5
1.6	.94520	.94630	.94738	.94845	.94950	1.6
1.7	.95543	.95637	.95728	.95818	.95907	1.7
1.8	.96407	.96485	.96562	.96637	.96711	1.8
1.9	.97128	.97193	.97257	.97320	.97381	1.9
2.0	.97725	.97778	.97831	.97882	.97932	2.0
2.1	.98214	.98257	.98300	.98341	.98382	2.1
2.2	.98610	.98645	.98679	.98713	.98745	2.2
2.3	.98928	.98956	.98983	.99010	.99036	2.3
2.4	.99180	.99202	.99224	.99245	.99266	2.4
2.5	.99379	.99396	.99413	.99430	.99446	2.5
2.6	.99534	.99547	.99560	.99573	.99585	2.6
2.7	.99653	.99664	.99674	.99683	.99693	2.7
2.8	.99744	.99752	.99760	.99767	.99774	2.8
2.9	.99813	.99819	.99825	.99831	.99836	2.9
3.0	.99865	.99869	.99874	.99878	.99882	3.0
3.1	.99903	.99906	.99910	.99913	.99916	3.1
3.2	.99931	.99934	.99936	.99938	.99940	3.2
3.3	.99952	.99953	.99955	.99957	.99958	3.3
3.4	.99966	.99968	.99969	.99970	.99971	3.4
3.5	.99977	.99978	.99978	.99979	.99980	3.5
3.6	.99984	.99985	.99985	.99986	.99986	3.6
3.7	.99989	.99990	.99990	.99990	.99991	3.7
3.8	.99993	.99993	.99993	.99994	.99994	3.8
3.9	.99995	.99995	.99996	.99996	.99996	3.9

TABLE A.1 (Continued)

$$\Phi(z) = \int_{-\infty}^z \frac{1}{\sqrt{2\pi}} e^{-u^2/2} du$$

z	.05	.06	.07	.08	.09	z
.0	.51994	.52392	.52790	.53188	.53586	.0
.1	.55962	.56356	.56749	.57142	.57534	.1
.2	.59871	.60257	.60642	.61026	.61409	.2
.3	.63683	.64058	.64431	.64803	.65173	.3
.4	.67364	.67724	.68082	.68438	.68793	.4
.5	.70884	.71226	.71566	.71904	.72240	.5
.6	.74215	.74537	.74857	.75175	.75490	.6
.7	.77337	.77637	.77935	.78230	.78523	.7
.8	.80234	.80510	.80785	.81057	.81327	.8
.9	.82894	.83147	.83397	.83646	.83891	.9
1.0	.85314	.85543	.85769	.85993	.86214	1.0
1.1	.87493	.87697	.87900	.88100	.88297	1.1
1.2	.89435	.89616	.89796	.89973	.90147	1.2
1.3	.91149	.91308	.91465	.91621	.91773	1.3
1.4	.92647	.92785	.92922	.93056	.93189	1.4
1.5	.93943	.94062	.94179	.94295	.94408	1.5
1.6	.95053	.95154	.95254	.95352	.95448	1.6
1.7	.95994	.96080	.96164	.96246	.96327	1.7
1.8	.96784	.96856	.96926	.96995	.97062	1.8
1.9	.97441	.97500	.97558	.97615	.97660	1.9
2.0	.97982	.98030	.98077	.98124	.98169	2.0
2.1	.98422	.98461	.98500	.98537	.98574	2.1
2.2	.98778	.98809	.98840	.98870	.98899	2.2
2.3	.99061	.99086	.99111	.99134	.99158	2.3
2.4	.99286	.99305	.99324	.99343	.99361	2.4
2.5	.99461	.99477	.99492	.99506	.99520	2.5
2.6	.99598	.99609	.99621	.99632	.99643	2.6
2.7	.99702	.99711	.99720	.99728	.99736	2.7
2.8	.99781	.99788	.99795	.99801	.99807	2.8
2.9	.99841	.99846	.99851	.99856	.99861	2.9
3.0	.99886	.99889	.99893	.99897	.99900	3.0
3.1	.99918	.99921	.99924	.99926	.99929	3.1
3.2	.99942	.99944	.99946	.99948	.99950	3.2
3.3	.99960	.99961	.99962	.99964	.99965	3.3
3.4	.99972	.99973	.99974	.99975	.99976	3.4
3.5	.99981	.99981	.99982	.99983	.99983	3.5
3.6	.99987	.99987	.99988	.99988	.99989	3.6
3.7	.99991	.99992	.99992	.99992	.99992	3.7
3.8	.99994	.99994	.99995	.99995	.99995	3.8
3.9	.99996	.99996	.99996	.99997	.99997	3.9

Source: Reproduced with permission from *Probability and Statistics in Engineering and Management Science*, 3rd ed., 1990, by W. W. Hines and D. C. Montgomery, Wiley, New York.

TABLE A.2 Percentage Points of the χ^2 Distribution

ν	α										
	.995	.990	.975	.950	.900	.500	.100	.050	.025	.010	.005
1	.00+	.00+	.00+	.00+	.02	.45	2.71	3.84	5.02	6.63	7.88
2	.01	.02	.05	.10	.21	1.39	4.61	5.99	7.38	9.21	10.60
3	.07	.11	.22	.35	.58	2.37	6.25	7.81	9.35	11.34	12.84
4	.21	.30	.48	.71	1.06	3.36	7.48	9.49	11.14	13.28	14.86
5	.41	.55	.83	1.15	1.61	4.35	9.24	11.07	12.83	15.09	16.75
6	.68	.87	1.24	1.64	2.20	5.35	10.65	12.59	14.45	16.81	18.55
7	.99	1.24	1.69	2.17	2.83	6.35	12.02	14.07	16.01	18.48	20.28
8	1.34	1.65	2.18	2.73	3.49	7.34	13.36	15.51	17.53	20.09	21.96
9	1.73	2.09	2.70	3.33	4.17	8.34	14.68	16.92	19.02	21.67	23.59
10	2.16	2.56	3.25	2.94	4.87	9.34	15.99	18.31	20.48	23.21	25.19
11	2.60	3.05	3.82	4.57	5.58	10.34	17.28	19.68	21.92	24.72	26.76
12	3.07	3.57	4.40	5.23	6.30	11.34	18.55	21.03	23.34	26.22	28.30
13	3.57	4.11	5.01	5.89	7.04	12.34	19.81	22.36	24.74	27.69	29.82
14	4.07	4.66	5.63	6.57	7.79	13.34	21.06	23.68	26.12	29.14	31.32
15	4.60	5.23	6.27	7.26	8.55	14.34	22.31	25.00	27.49	30.58	32.80
16	5.14	5.81	6.91	7.96	9.31	15.34	23.54	26.30	28.85	32.00	34.27
17	5.70	6.41	7.56	8.67	10.09	16.34	24.77	27.59	30.19	33.41	35.72
18	6.26	7.01	8.23	9.39	10.87	17.34	25.99	28.87	31.53	34.81	37.16
19	6.84	7.63	8.91	10.12	11.65	18.34	27.20	30.14	32.85	36.19	38.58
20	7.43	8.26	9.59	10.85	12.44	19.34	28.41	31.41	34.17	37.57	40.00
21	8.03	8.90	10.28	11.59	13.24	20.34	29.62	32.67	35.48	38.93	41.40
22	8.64	9.54	10.98	12.34	14.04	21.34	30.81	33.92	36.78	40.29	42.80
23	9.26	10.20	11.69	13.09	14.85	22.34	32.01	35.17	38.08	41.64	44.18
24	9.89	10.86	12.40	13.85	15.66	23.34	33.20	36.42	39.36	42.98	45.45
25	10.52	11.52	13.12	14.61	16.47	24.34	34.28	37.65	40.65	44.31	46.93
26	11.16	12.20	13.84	15.38	17.29	25.34	35.56	38.89	41.92	45.64	48.29
27	11.81	12.88	14.57	16.15	18.11	26.34	36.74	40.11	43.19	46.96	49.65
28	12.46	13.57	15.31	16.93	18.94	27.34	37.92	41.34	44.46	48.28	50.99
29	13.12	14.26	16.05	17.71	19.77	28.34	39.09	42.56	45.72	49.59	52.34
30	13.79	14.95	16.79	18.49	20.60	29.34	40.26	43.77	46.98	50.89	53.67
40	20.71	22.16	24.43	26.51	29.05	39.34	51.81	55.76	59.34	63.69	66.77
50	27.99	29.71	32.36	34.76	37.69	49.33	63.17	67.50	71.42	76.15	79.49
60	35.53	37.48	40.48	43.19	46.46	59.33	74.40	79.08	83.30	88.38	91.95
70	43.28	45.44	48.76	51.74	55.33	69.33	85.53	90.53	95.02	100.42	104.22
80	51.17	53.54	57.15	60.39	64.28	79.33	96.58	101.88	106.63	112.33	116.32
90	59.20	61.75	65.65	69.13	73.29	89.33	107.57	113.14	118.14	124.12	128.30
100	67.33	70.06	74.22	77.93	82.36	99.33	118.50	124.34	139.56	135.81	140.17

ν = degrees of freedom.

Source: Reproduced with permission from *Probability and in Engineering and Management Science*, 3rd ed., 1990, by W. W. Hines and D. C. Montgomery, Wiley, New York.

TABLE A.3 Percentage Points of the *t* Distribution

<i>v</i>	<i>α</i>									
	.40	.25	.10	.05	.025	.01	.005	.0025	.001	.0005
1	.325	1.000	3.078	6.314	12.706	31.821	63.657	127.32	318.31	636.62
2	.289	.816	1.886	2.920	4.303	6.965	9.925	14.089	23.326	31.598
3	.277	.765	1.638	2.353	3.182	4.541	5.841	7.453	10.213	12.924
4	.271	.741	1.533	2.132	2.776	3.747	4.604	5.598	7.173	8.610
5	.267	.727	1.476	2.015	2.571	3.365	4.032	4.773	5.893	6.869
6	.265	.718	1.440	1.943	2.447	3.143	3.707	4.317	5.208	5.959
7	.263	.711	1.415	1.895	2.365	2.998	3.499	4.029	4.785	5.408
8	.262	.706	1.397	1.860	2.306	2.896	3.355	2.833	4.504	5.041
9	.261	.703	1.383	1.833	2.262	2.821	3.250	3.690	4.297	4.781
10	.260	.700	1.372	1.812	2.228	2.764	3.169	3.581	4.144	4.587
11	.260	.697	1.363	1.796	2.201	2.718	3.106	3.497	4.025	4.437
12	.259	.695	1.356	1.782	2.179	2.681	3.055	3.428	3.930	4.318
13	.259	.694	1.350	1.771	2.160	2.650	3.012	3.372	3.852	4.221
14	.258	.692	1.345	1.761	2.145	2.624	2.977	3.326	3.787	4.140
15	.258	.691	1.341	1.753	2.131	2.602	2.947	3.286	3.733	4.073
16	.258	.690	1.337	1.746	2.120	2.583	2.921	3.252	3.686	4.015
17	.257	.689	1.333	1.740	2.110	2.567	2.898	3.222	3.646	3.965
18	.257	.688	1.330	1.734	2.101	2.552	2.878	3.197	3.610	3.922
19	.257	.688	1.328	1.729	2.093	2.539	2.861	3.174	3.579	3.883
20	.257	.687	1.325	1.725	2.086	2.528	2.845	3.153	3.552	3.850
21	.257	.686	1.323	1.721	2.080	2.518	2.831	3.135	3.527	3.819
22	.256	.686	1.321	1.717	2.074	2.508	2.819	3.119	3.505	3.792
23	.256	.685	1.319	1.714	2.069	2.500	2.807	3.104	3.485	2.767
24	.256	.685	1.318	1.711	2.064	2.492	2.797	3.091	3.467	3.745
25	.256	.684	1.316	1.708	2.060	2.485	2.787	3.078	3.450	3.725
26	.256	.684	1.315	1.706	2.056	2.479	2.779	3.067	3.435	3.707
27	.256	.684	1.314	1.703	2.052	2.473	2.771	3.057	3.421	3.690
28	.256	.683	1.313	1.701	2.048	2.467	2.763	3.047	3.408	2.674
29	.256	.683	1.311	1.699	2.045	2.462	2.756	3.308	3.396	3.659
30	.256	.683	1.310	1.697	2.042	2.457	2.750	3.030	3.385	3.646
40	.255	.681	1.303	1.648	2.021	2.423	2.704	2.971	3.307	3.551
60	.254	.679	1.296	1.671	2.000	2.390	2.660	2.915	3.232	3.460
120	.254	.677	1.289	1.658	1.980	2.358	2.617	2.860	3.160	3.373
∞	.253	.674	1.282	1.645	1.960	2.326	2.576	2.807	3.090	3.291

Source: Adapted with pennission from *Biometrika Tables for Statisticians*, Vol. 1, 3rd ed., 1966, by E. S. Pearson and H. O. Hartley, Cambridge University Press, Cambridge.

TABLE A.4 Percentage Points of the F-Distribution

$F_{.25; \nu_1, \nu_2}$

ν_2	Degrees of Freedom for the Numerator (ν_1)																	∞	
	1	2	3	4	5	6	7	8	9	10	12	15	20	24	30	40	60		120
1	5.83	7.50	8.20	8.58	8.82	8.98	9.10	9.19	9.26	9.32	9.41	9.49	9.58	9.63	9.67	9.71	9.76	9.80	9.85
2	2.57	3.00	3.15	3.23	3.28	3.31	3.34	3.35	3.37	3.38	3.39	3.41	3.43	3.43	3.44	3.45	3.46	3.47	3.48
3	2.02	2.28	2.36	2.39	2.41	2.42	2.43	2.44	2.44	2.44	2.45	2.46	2.46	2.46	2.47	2.47	2.47	2.47	2.47
4	1.81	2.00	2.05	2.06	2.07	2.08	2.08	2.08	2.08	2.08	2.08	2.08	2.08	2.08	2.08	2.08	2.08	2.08	2.08
5	1.69	1.85	1.88	1.89	1.89	1.89	1.89	1.89	1.89	1.89	1.89	1.89	1.88	1.88	1.88	1.88	1.87	1.87	1.87
6	1.62	1.76	1.78	1.79	1.79	1.78	1.78	1.78	1.77	1.77	1.77	1.76	1.76	1.75	1.75	1.75	1.74	1.74	1.74
7	1.57	1.70	1.72	1.72	1.71	1.71	1.70	1.70	1.70	1.69	1.68	1.68	1.67	1.67	1.66	1.66	1.65	1.65	1.65
8	1.54	1.66	1.67	1.66	1.66	1.65	1.64	1.64	1.63	1.63	1.62	1.62	1.61	1.60	1.60	1.59	1.59	1.58	1.58
9	1.51	1.62	1.63	1.63	1.62	1.61	1.60	1.60	1.59	1.59	1.58	1.57	1.56	1.56	1.55	1.54	1.54	1.53	1.53
10	1.49	1.60	1.60	1.59	1.59	1.58	1.57	1.56	1.56	1.55	1.54	1.53	1.52	1.52	1.51	1.51	1.50	1.49	1.48
11	1.47	1.58	1.58	1.57	1.56	1.55	1.54	1.53	1.53	1.52	1.51	1.50	1.49	1.49	1.48	1.47	1.47	1.46	1.45
12	1.46	1.56	1.56	1.55	1.54	1.53	1.52	1.51	1.51	1.50	1.49	1.48	1.47	1.46	1.45	1.45	1.44	1.43	1.42
13	1.45	1.55	1.55	1.53	1.52	1.51	1.50	1.49	1.49	1.48	1.47	1.46	1.45	1.44	1.43	1.42	1.42	1.41	1.40
14	1.44	1.53	1.53	1.52	1.51	1.50	1.49	1.48	1.47	1.46	1.45	1.44	1.43	1.42	1.41	1.41	1.40	1.39	1.38
15	1.43	1.52	1.52	1.51	1.49	1.48	1.47	1.46	1.46	1.45	1.44	1.43	1.41	1.41	1.40	1.39	1.38	1.37	1.36
16	1.42	1.51	1.51	1.50	1.48	1.47	1.46	1.45	1.44	1.44	1.43	1.41	1.40	1.39	1.38	1.37	1.36	1.35	1.34
17	1.42	1.51	1.50	1.49	1.47	1.46	1.45	1.44	1.43	1.43	1.41	1.40	1.39	1.38	1.37	1.36	1.35	1.34	1.33
18	1.41	1.50	1.49	1.48	1.46	1.45	1.44	1.43	1.42	1.42	1.40	1.39	1.38	1.37	1.36	1.35	1.34	1.33	1.32
19	1.41	1.49	1.49	1.47	1.46	1.44	1.43	1.42	1.41	1.41	1.40	1.38	1.37	1.36	1.35	1.34	1.33	1.32	1.30
20	1.40	1.49	1.48	1.47	1.45	1.44	1.43	1.42	1.41	1.40	1.39	1.37	1.36	1.35	1.34	1.33	1.32	1.31	1.29
21	1.40	1.48	1.48	1.46	1.44	1.43	1.42	1.41	1.40	1.39	1.38	1.37	1.35	1.34	1.33	1.32	1.31	1.30	1.28
22	1.40	1.48	1.47	1.45	1.44	1.42	1.41	1.40	1.39	1.39	1.37	1.36	1.34	1.33	1.32	1.31	1.30	1.29	1.28
23	1.39	1.47	1.47	1.45	1.43	1.42	1.41	1.40	1.39	1.38	1.37	1.35	1.34	1.33	1.32	1.31	1.30	1.28	1.27
24	1.39	1.47	1.46	1.44	1.43	1.41	1.40	1.39	1.38	1.38	1.36	1.35	1.33	1.32	1.31	1.30	1.29	1.28	1.26
25	1.39	1.47	1.46	1.44	1.42	1.41	1.40	1.39	1.38	1.37	1.36	1.34	1.33	1.32	1.31	1.29	1.28	1.27	1.25
26	1.38	1.46	1.45	1.44	1.42	1.41	1.39	1.38	1.37	1.37	1.35	1.34	1.32	1.31	1.30	1.29	1.28	1.26	1.25
27	1.38	1.46	1.45	1.43	1.42	1.40	1.39	1.38	1.37	1.36	1.35	1.33	1.32	1.31	1.30	1.28	1.27	1.26	1.24
28	1.38	1.46	1.45	1.43	1.41	1.40	1.39	1.38	1.37	1.36	1.34	1.33	1.31	1.30	1.29	1.28	1.27	1.25	1.24
29	1.38	1.45	1.45	1.43	1.41	1.40	1.38	1.37	1.36	1.35	1.34	1.32	1.31	1.30	1.29	1.27	1.26	1.25	1.23
30	1.38	1.45	1.44	1.42	1.41	1.39	1.38	1.37	1.36	1.35	1.34	1.32	1.30	1.29	1.28	1.27	1.26	1.24	1.23
40	1.36	1.44	1.42	1.40	1.39	1.37	1.36	1.35	1.34	1.33	1.31	1.30	1.28	1.26	1.25	1.24	1.22	1.21	1.19
60	1.35	1.42	1.41	1.38	1.37	1.35	1.33	1.32	1.31	1.30	1.29	1.27	1.25	1.24	1.22	1.21	1.19	1.17	1.15
120	1.34	1.40	1.39	1.37	1.35	1.33	1.31	1.30	1.29	1.28	1.26	1.24	1.22	1.21	1.19	1.18	1.16	1.13	1.10
∞	1.32	1.39	1.37	1.35	1.33	1.31	1.29	1.28	1.27	1.25	1.24	1.22	1.19	1.18	1.16	1.14	1.12	1.08	1.00

Degrees of Freedom for the Numerator (ν_1)

ν_2	1	2	3	4	5	6	7	8	9	10	12	15	20	24	30	40	60	120	∞
1	39.86	49.50	53.59	55.83	57.24	58.20	58.91	59.44	59.86	60.19	60.71	61.22	61.74	62.00	62.26	62.53	62.79	63.06	63.33
2	8.53	9.00	9.16	9.24	9.29	9.33	9.35	9.37	9.38	9.39	9.41	9.42	9.44	9.45	9.46	9.47	9.47	9.48	9.49
3	5.54	5.46	5.39	5.34	5.31	5.28	5.27	5.25	5.24	5.23	5.22	5.20	5.18	5.18	5.17	5.16	5.15	5.14	5.13
4	4.54	4.32	4.19	4.11	4.05	4.01	3.98	3.95	3.94	3.92	3.90	3.87	3.84	3.83	3.82	3.80	3.79	3.78	3.76
5	4.06	3.78	3.62	3.52	3.45	3.40	3.37	3.34	3.32	3.30	3.27	3.24	3.21	3.19	3.17	3.16	3.14	3.12	3.10
6	3.78	3.46	3.29	3.18	3.11	3.05	3.01	2.98	2.96	2.94	2.90	2.87	2.84	2.82	2.80	2.78	2.76	2.74	2.72
7	3.59	3.26	3.07	2.96	2.88	2.83	2.78	2.75	2.72	2.70	2.67	2.63	2.59	2.58	2.56	2.54	2.51	2.49	2.47
8	3.46	3.11	2.92	2.81	2.73	2.67	2.62	2.59	2.56	2.54	2.50	2.46	2.42	2.40	2.38	2.36	2.34	2.32	2.29
9	3.36	3.01	2.81	2.69	2.61	2.55	2.51	2.47	2.44	2.42	2.38	2.34	2.30	2.28	2.25	2.23	2.21	2.18	2.16
10	3.29	2.92	2.73	2.61	2.52	2.46	2.41	2.38	2.35	2.32	2.28	2.24	2.20	2.18	2.16	2.13	2.11	2.08	2.06
11	3.23	2.86	2.66	2.54	2.45	2.39	2.34	2.30	2.27	2.25	2.21	2.17	2.12	2.10	2.08	2.05	2.03	2.00	1.97
12	3.18	2.81	2.61	2.48	2.39	2.33	2.28	2.24	2.21	2.19	2.15	2.10	2.06	2.04	2.01	1.99	1.96	1.93	1.90
13	3.14	2.76	2.56	2.43	2.35	2.28	2.23	2.20	2.16	2.14	2.10	2.05	2.01	1.98	1.96	1.93	1.90	1.88	1.85
14	3.10	2.73	2.52	2.39	2.31	2.24	2.19	2.15	2.12	2.10	2.05	2.01	1.96	1.94	1.91	1.89	1.86	1.83	1.80
15	3.07	2.70	2.49	2.36	2.27	2.21	2.16	2.12	2.09	2.06	2.02	1.97	1.92	1.90	1.87	1.85	1.82	1.79	1.76
16	3.05	2.67	2.46	2.33	2.24	2.18	2.13	2.09	2.06	2.03	1.99	1.94	1.89	1.87	1.84	1.81	1.78	1.75	1.72
17	3.03	2.64	2.44	2.31	2.22	2.15	2.10	2.06	2.03	2.00	1.96	1.91	1.86	1.84	1.81	1.78	1.75	1.72	1.69
18	3.01	2.62	2.42	2.29	2.20	2.13	2.08	2.04	2.00	1.98	1.93	1.89	1.84	1.81	1.78	1.75	1.72	1.69	1.66
19	2.99	2.61	2.40	2.27	2.18	2.11	2.06	2.02	1.98	1.96	1.91	1.86	1.81	1.79	1.76	1.73	1.70	1.67	1.63
20	2.97	2.59	2.38	2.25	2.16	2.09	2.04	2.00	1.96	1.94	1.89	1.84	1.79	1.77	1.74	1.71	1.68	1.64	1.61
21	2.96	2.57	2.36	2.23	2.14	2.08	2.02	1.98	1.95	1.92	1.87	1.83	1.78	1.75	1.72	1.69	1.66	1.62	1.59
22	2.95	2.56	2.35	2.22	2.13	2.06	2.01	1.97	1.93	1.90	1.86	1.81	1.76	1.73	1.70	1.67	1.64	1.60	1.57
23	2.94	2.55	2.34	2.21	2.11	2.05	1.99	1.95	1.92	1.89	1.84	1.80	1.74	1.72	1.69	1.66	1.62	1.59	1.55
24	2.93	2.54	2.33	2.19	2.10	2.04	1.98	1.94	1.91	1.88	1.83	1.78	1.73	1.70	1.67	1.64	1.61	1.57	1.53
25	2.92	2.53	2.32	2.18	2.09	2.02	1.97	1.93	1.89	1.87	1.82	1.77	1.72	1.69	1.66	1.63	1.59	1.56	1.52
26	2.91	2.52	2.31	2.17	2.08	2.01	1.96	1.92	1.88	1.86	1.81	1.76	1.71	1.68	1.65	1.61	1.58	1.54	1.50
27	2.90	2.51	2.30	2.17	2.07	2.00	1.95	1.91	1.87	1.85	1.80	1.75	1.70	1.67	1.64	1.60	1.57	1.53	1.49
28	2.89	2.50	2.29	2.16	2.06	2.00	1.94	1.90	1.87	1.84	1.79	1.74	1.69	1.66	1.63	1.59	1.56	1.52	1.48
29	2.89	2.50	2.28	2.15	2.06	1.99	1.93	1.89	1.86	1.83	1.78	1.73	1.68	1.65	1.62	1.58	1.55	1.51	1.47
30	2.88	2.49	2.28	2.14	2.03	1.98	1.93	1.88	1.85	1.82	1.77	1.72	1.67	1.64	1.61	1.57	1.54	1.50	1.46
40	2.84	2.44	2.23	2.09	2.00	1.93	1.87	1.83	1.79	1.76	1.71	1.66	1.61	1.57	1.54	1.51	1.47	1.42	1.38
60	2.79	2.39	2.18	2.04	1.95	1.87	1.82	1.77	1.74	1.71	1.66	1.60	1.54	1.51	1.48	1.44	1.40	1.35	1.29
120	2.75	2.35	2.13	1.99	1.90	1.82	1.77	1.72	1.68	1.65	1.60	1.55	1.48	1.45	1.41	1.37	1.32	1.26	1.19
∞	2.17	2.30	2.08	1.94	1.85	1.77	1.72	1.67	1.63	1.60	1.55	1.49	1.42	1.38	1.34	1.30	1.24	1.17	1.00

Degrees of Freedom for the Denominator (ν_2)

(Continued)

TABLE A.4 (Continued)

		Degrees of Freedom for the Numerator (ν_1)																		
		1	2	3	4	5	6	7	8	9	10	12	15	20	24	30	40	60	120	∞
Degrees of Freedom for the Denominator (ν_2)	1	161.4	199.5	215.7	224.6	230.2	234.0	236.8	238.9	240.5	241.9	243.9	245.9	248.0	249.1	250.1	251.1	252.2	253.3	254.3
	2	18.51	19.00	19.16	19.25	19.30	19.33	19.35	19.37	19.38	19.40	19.41	19.43	19.45	19.45	19.46	19.47	19.48	19.49	19.50
	3	10.13	9.55	9.28	9.12	9.01	8.94	8.89	8.85	8.81	8.79	8.74	8.70	8.66	8.64	8.62	8.59	8.57	8.55	8.53
	4	7.71	6.94	6.59	6.39	6.26	6.16	6.09	6.04	6.00	5.96	5.91	5.86	5.80	5.77	5.75	5.72	5.69	5.66	5.63
	5	6.61	5.79	5.41	5.19	5.05	4.95	4.88	4.82	4.77	4.74	4.68	4.62	4.56	4.53	4.50	4.46	4.43	4.40	4.36
	6	5.99	5.14	4.76	4.53	4.39	4.28	4.21	4.15	4.10	4.06	4.00	3.94	3.87	3.84	3.81	3.77	3.74	3.70	3.67
	7	5.59	4.74	4.35	4.12	3.97	3.87	3.79	3.73	3.68	3.64	3.57	3.51	3.44	3.41	3.38	3.34	3.30	3.27	3.23
	8	5.32	4.46	4.07	3.84	3.69	3.58	3.50	3.44	3.39	3.35	3.30	3.22	3.15	3.12	3.08	3.04	3.01	2.97	2.93
	9	5.12	4.26	3.86	3.63	3.48	3.37	3.29	3.23	3.18	3.14	3.07	3.01	2.94	2.90	2.86	2.83	2.79	2.75	2.71
	10	4.96	4.10	3.71	3.48	3.33	3.22	3.14	3.07	3.02	2.98	2.91	2.85	2.77	2.74	2.70	2.66	2.62	2.58	2.54
	11	4.48	3.98	3.59	3.36	3.20	3.09	3.01	2.95	2.90	2.85	2.75	2.69	2.62	2.54	2.51	2.47	2.43	2.38	2.30
	12	4.75	3.89	3.41	3.18	3.03	2.92	2.83	2.77	2.71	2.67	2.60	2.53	2.46	2.42	2.38	2.34	2.30	2.25	2.21
13	4.67	3.81	3.41	3.18	3.03	2.92	2.83	2.77	2.71	2.67	2.60	2.53	2.46	2.39	2.35	2.31	2.27	2.22	2.18	
14	4.60	3.74	3.34	3.11	2.96	2.85	2.76	2.70	2.65	2.60	2.53	2.46	2.39	2.32	2.29	2.25	2.20	2.16	2.11	
15	4.54	3.68	3.29	3.06	2.90	2.79	2.71	2.64	2.59	2.54	2.49	2.42	2.35	2.28	2.24	2.19	2.15	2.11	2.06	
16	4.49	3.63	3.24	3.01	2.85	2.74	2.66	2.59	2.54	2.49	2.42	2.35	2.28	2.22	2.18	2.15	2.10	2.06	2.01	
17	4.45	3.59	3.20	2.96	2.81	2.70	2.62	2.55	2.49	2.45	2.38	2.31	2.24	2.19	2.15	2.10	2.06	2.01	1.96	
18	4.41	3.55	3.16	2.93	2.77	2.66	2.58	2.51	2.46	2.41	2.34	2.27	2.19	2.15	2.11	2.06	2.02	1.97	1.92	
19	4.38	3.52	3.13	2.90	2.74	2.63	2.54	2.48	2.42	2.38	2.31	2.23	2.16	2.11	2.07	2.03	1.98	1.93	1.88	
20	4.35	3.49	3.10	2.87	2.71	2.60	2.51	2.45	2.39	2.35	2.28	2.20	2.12	2.08	2.04	1.99	1.95	1.90	1.84	
21	4.32	3.47	3.07	2.84	2.68	2.57	2.49	2.42	2.37	2.32	2.25	2.18	2.10	2.05	2.01	1.96	1.92	1.87	1.81	
22	4.30	3.44	3.05	2.82	2.66	2.55	2.46	2.40	2.34	2.30	2.23	2.15	2.07	2.03	1.98	1.94	1.89	1.84	1.78	
23	4.28	3.42	3.03	2.80	2.64	2.53	2.44	2.37	2.32	2.27	2.20	2.13	2.05	2.01	1.96	1.91	1.86	1.81	1.76	
24	4.26	3.40	3.01	2.78	2.62	2.51	2.42	2.36	2.30	2.25	2.18	2.11	2.03	1.98	1.94	1.89	1.84	1.79	1.73	
25	4.24	3.39	2.99	2.76	2.60	2.49	2.40	2.34	2.28	2.24	2.16	2.09	2.01	1.96	1.92	1.87	1.82	1.77	1.71	
26	4.23	3.37	2.98	2.74	2.59	2.47	2.39	2.32	2.27	2.22	2.15	2.07	1.99	1.95	1.90	1.85	1.80	1.75	1.69	
27	4.21	3.35	2.96	2.73	2.57	2.46	2.37	2.31	2.25	2.20	2.13	2.06	1.97	1.93	1.88	1.84	1.79	1.73	1.67	
28	4.20	3.34	2.95	2.71	2.56	2.45	2.36	2.29	2.24	2.19	2.12	2.04	1.96	1.91	1.87	1.82	1.77	1.71	1.65	
29	4.18	3.33	2.93	2.70	2.55	2.43	2.35	2.28	2.22	2.18	2.10	2.03	1.94	1.90	1.85	1.81	1.75	1.70	1.64	
30	4.17	3.32	2.92	2.69	2.53	2.42	2.33	2.27	2.21	2.16	2.09	2.01	1.92	1.89	1.84	1.79	1.74	1.68	1.62	
40	4.08	3.23	2.84	2.61	2.45	2.34	2.25	2.18	2.12	2.08	2.00	1.92	1.84	1.79	1.74	1.69	1.64	1.58	1.51	
60	4.00	3.15	2.76	2.53	2.37	2.25	2.17	2.10	2.04	1.99	1.92	1.84	1.75	1.70	1.65	1.59	1.53	1.47	1.39	
120	3.92	3.07	2.68	2.45	2.29	2.17	2.09	2.02	1.96	1.91	1.83	1.75	1.66	1.61	1.55	1.49	1.43	1.35	1.25	
∞	3.84	3.00	2.60	2.37	2.21	2.10	2.01	1.94	1.88	1.83	1.75	1.67	1.57	1.52	1.46	1.39	1.32	1.22	1.00	

$F_{0.05, v_1, v_2}$

Degrees of Freedom for the Numerator (v_1)

v_2	1	2	3	4	5	6	7	8	9	10	12	15	20	24	30	40	60	100	1010	1014	120	∞	
1	647.8	799.5	864.2	899.6	921.8	937.1	948.2	956.7	963.3	968.6	976.7	984.9	993.1	997.2	1001	1006	1010	1014	1018	1018	1014	120	∞
2	38.51	39.00	39.17	39.25	39.30	39.33	39.36	39.37	39.39	39.40	39.41	39.43	39.45	39.46	39.46	39.47	39.48	39.49	39.50	39.50	39.49	120	1018
3	17.44	16.04	15.44	15.10	14.88	14.73	14.62	14.54	14.47	14.42	14.34	14.25	14.17	14.12	14.08	14.04	13.99	13.95	13.90	13.90	13.95	120	1018
4	12.22	10.65	9.98	9.60	9.36	9.20	9.07	8.98	8.90	8.84	8.75	8.66	8.56	8.51	8.46	8.41	8.36	8.31	8.26	8.26	8.31	120	1018
5	10.01	8.43	7.76	7.39	7.15	6.98	6.85	6.76	6.68	6.62	6.52	6.43	6.33	6.28	6.23	6.18	6.12	6.07	6.02	6.02	6.07	120	1018
6	8.81	7.26	6.60	6.23	5.99	5.82	5.70	5.60	5.52	5.46	5.37	5.27	5.17	5.12	5.07	5.01	4.96	4.90	4.85	4.85	4.90	120	1018
7	8.07	6.54	5.89	5.52	5.29	5.12	4.99	4.90	4.82	4.76	4.67	4.57	4.47	4.42	4.36	4.31	4.25	4.20	4.14	4.14	4.20	120	1018
8	7.57	6.06	5.42	5.05	4.82	4.65	4.53	4.43	4.36	4.30	4.20	4.10	4.00	3.95	3.89	3.84	3.78	3.73	3.67	3.67	3.73	120	1018
9	7.21	5.71	5.08	4.72	4.48	4.32	4.20	4.10	4.03	3.96	3.87	3.77	3.67	3.61	3.56	3.51	3.45	3.39	3.33	3.33	3.39	120	1018
10	6.94	5.46	4.83	4.47	4.24	4.07	3.95	3.85	3.78	3.72	3.62	3.52	3.42	3.37	3.31	3.26	3.20	3.14	3.08	3.08	3.14	120	1018
11	6.72	5.26	4.63	4.28	4.04	3.88	3.76	3.66	3.59	3.53	3.43	3.33	3.23	3.17	3.12	3.06	3.00	2.94	2.88	2.88	2.94	120	1018
12	6.55	5.10	4.47	4.12	3.89	3.73	3.61	3.51	3.44	3.37	3.28	3.18	3.07	3.02	2.96	2.91	2.85	2.79	2.72	2.72	2.79	120	1018
13	6.41	4.97	4.35	4.00	3.77	3.60	3.48	3.39	3.31	3.25	3.15	3.05	2.95	2.89	2.84	2.78	2.72	2.66	2.60	2.60	2.66	120	1018
14	6.30	4.86	4.24	3.89	3.66	3.50	3.38	3.29	3.21	3.15	3.05	2.95	2.84	2.79	2.73	2.67	2.61	2.55	2.49	2.49	2.55	120	1018
15	6.20	4.77	4.15	3.80	3.58	3.41	3.29	3.20	3.12	3.06	2.96	2.86	2.76	2.70	2.64	2.59	2.52	2.46	2.40	2.40	2.46	120	1018
16	6.12	4.69	4.08	3.73	3.50	3.34	3.22	3.12	3.05	2.99	2.89	2.79	2.68	2.63	2.57	2.51	2.45	2.38	2.32	2.32	2.38	120	1018
17	6.04	4.62	4.01	3.66	3.44	3.28	3.16	3.06	2.98	2.92	2.82	2.72	2.62	2.56	2.50	2.44	2.38	2.32	2.25	2.25	2.32	120	1018
18	5.98	4.56	3.95	3.61	3.38	3.22	3.10	3.01	2.93	2.87	2.77	2.67	2.56	2.50	2.44	2.38	2.32	2.26	2.19	2.19	2.26	120	1018
19	5.92	4.51	3.90	3.56	3.33	3.17	3.05	2.96	2.88	2.82	2.72	2.62	2.51	2.45	2.39	2.33	2.27	2.20	2.13	2.13	2.20	120	1018
20	5.87	4.46	3.86	3.51	3.29	3.13	3.01	2.91	2.84	2.77	2.68	2.57	2.46	2.41	2.35	2.29	2.22	2.16	2.09	2.09	2.16	120	1018
21	5.83	4.42	3.82	3.48	3.25	3.09	2.97	2.87	2.80	2.73	2.64	2.53	2.42	2.37	2.31	2.25	2.18	2.11	2.04	2.04	2.11	120	1018
22	5.79	4.38	3.78	3.44	3.22	3.05	2.93	2.84	2.76	2.70	2.60	2.50	2.39	2.33	2.27	2.21	2.14	2.08	2.00	2.00	2.08	120	1018
23	5.75	4.35	3.75	3.41	3.18	3.02	2.90	2.81	2.73	2.67	2.57	2.47	2.36	2.30	2.24	2.18	2.11	2.04	1.97	1.97	2.04	120	1018
24	5.72	4.32	3.72	3.38	3.15	2.99	2.87	2.78	2.70	2.64	2.54	2.44	2.33	2.27	2.21	2.15	2.08	2.01	1.94	1.94	2.01	120	1018
25	5.69	4.29	3.69	3.35	3.13	2.97	2.85	2.75	2.68	2.61	2.51	2.41	2.30	2.24	2.18	2.12	2.05	1.98	1.91	1.91	1.98	120	1018
26	5.66	4.27	3.67	3.33	3.10	2.94	2.82	2.73	2.65	2.59	2.49	2.39	2.28	2.22	2.16	2.09	2.03	1.95	1.88	1.88	1.95	120	1018
27	5.63	4.24	3.65	3.31	3.08	2.92	2.80	2.71	2.63	2.57	2.47	2.36	2.25	2.19	2.13	2.07	2.00	1.93	1.85	1.85	1.93	120	1018
28	5.61	4.22	3.63	3.29	3.06	2.90	2.78	2.69	2.61	2.55	2.45	2.34	2.23	2.17	2.11	2.05	1.98	1.91	1.83	1.83	1.91	120	1018
29	5.59	4.20	3.61	3.27	3.04	2.88	2.76	2.67	2.59	2.53	2.43	2.32	2.21	2.15	2.09	2.03	1.96	1.89	1.81	1.81	1.89	120	1018
30	5.57	4.18	3.59	3.25	3.03	2.87	2.75	2.65	2.57	2.51	2.41	2.31	2.20	2.14	2.07	2.01	1.94	1.87	1.79	1.79	1.87	120	1018
40	5.42	4.05	3.46	3.13	2.90	2.74	2.62	2.53	2.45	2.39	2.29	2.18	2.07	2.01	1.94	1.88	1.80	1.72	1.64	1.64	1.72	120	1018
60	5.29	3.93	3.34	3.01	2.79	2.63	2.51	2.41	2.33	2.27	2.17	2.06	1.94	1.88	1.82	1.74	1.67	1.58	1.48	1.48	1.58	120	1018
120	5.15	3.80	3.23	2.89	2.67	2.52	2.39	2.30	2.22	2.16	2.05	1.94	1.82	1.76	1.69	1.61	1.53	1.43	1.31	1.31	1.43	120	1018
∞	5.02	3.69	3.12	2.79	2.57	2.41	2.29	2.19	2.11	2.05	1.94	1.83	1.71	1.64	1.57	1.48	1.39	1.27	1.10	1.10	1.27	120	1018

Degrees of Freedom for the Denominator (v_2)

(Continued)

TABLE A.4 (Continued)

$F_{0.01, v_1, v_2}$		Degrees of Freedom for the Numerator (v_1)																	
v_2	1	2	3	4	5	6	7	8	9	10	12	15	20	24	30	40	60	120	∞
1	4052	4999.5	5403	5625	5764	5859	5928	5982	6022	6056	6106	6157	6209	6235	6261	6287	6313	6339	6366
2	98.50	99.00	99.17	99.25	99.30	99.33	99.36	99.37	99.39	99.40	99.42	99.43	99.45	99.46	99.47	99.47	99.48	99.49	99.50
3	34.12	30.82	29.46	28.71	28.24	27.91	27.67	27.49	27.35	27.23	27.05	26.87	26.69	26.00	26.50	26.41	26.32	26.22	26.13
4	21.20	18.00	16.69	15.98	15.52	15.21	14.98	14.80	14.66	14.55	14.37	14.20	14.02	13.93	13.84	13.75	13.65	13.56	13.46
5	16.26	13.27	12.06	11.39	10.97	10.67	10.46	10.29	10.16	10.05	9.89	9.72	9.55	9.47	9.38	9.29	9.20	9.11	9.02
6	13.75	10.92	9.78	9.15	8.75	8.47	8.26	8.10	7.98	7.87	7.72	7.56	7.40	7.31	7.23	7.14	7.06	6.97	6.88
7	12.25	9.55	8.45	7.85	7.46	7.19	6.99	6.84	6.72	6.62	6.47	6.31	6.16	6.07	5.99	5.91	5.82	5.74	5.65
8	11.26	8.65	7.59	7.01	6.63	6.37	6.18	6.03	5.91	5.81	5.67	5.52	5.36	5.28	5.20	5.12	5.03	4.95	4.86
9	10.56	8.02	6.99	6.42	6.06	5.80	5.61	5.47	5.35	5.26	5.11	4.96	4.81	4.73	4.65	4.57	4.48	4.40	4.31
10	10.04	7.56	6.55	5.99	5.64	5.39	5.20	5.06	4.94	4.85	4.71	4.56	4.41	4.33	4.25	4.17	4.08	4.00	3.91
11	9.65	7.21	6.22	5.67	5.32	5.07	4.89	4.74	4.63	4.54	4.40	4.25	4.10	4.02	3.94	3.86	3.78	3.69	3.60
12	9.33	6.93	5.95	5.41	5.06	4.82	4.64	4.50	4.39	4.30	4.16	4.01	3.86	3.78	3.70	3.62	3.54	3.45	3.36
13	9.07	6.70	5.74	5.21	4.86	4.62	4.44	4.30	4.19	4.10	3.96	3.82	3.66	3.59	3.51	3.43	3.34	3.25	3.17
14	8.86	6.51	5.56	5.04	4.69	4.46	4.28	4.14	4.03	3.94	3.80	3.66	3.51	3.43	3.35	3.27	3.18	3.09	3.00
15	8.68	6.36	5.42	4.89	4.54	4.32	4.14	4.00	3.89	3.80	3.67	3.52	3.37	3.29	3.21	3.13	3.05	2.96	2.87
16	8.53	6.23	5.29	4.77	4.44	4.20	4.03	3.89	3.78	3.69	3.55	3.41	3.26	3.18	3.10	3.02	2.93	2.84	2.75
17	8.40	6.11	5.18	4.67	4.34	4.10	3.93	3.79	3.68	3.59	3.46	3.31	3.16	3.08	3.00	2.92	2.83	2.75	2.65
18	8.29	6.01	5.09	4.58	4.25	4.01	3.84	3.71	3.60	3.51	3.37	3.23	3.08	3.00	2.92	2.84	2.75	2.66	2.57
19	8.18	5.93	5.01	4.50	4.17	3.94	3.77	3.63	3.52	3.43	3.30	3.15	3.00	2.92	2.84	2.76	2.67	2.58	2.50
20	8.10	5.85	4.94	4.43	4.10	3.87	3.70	3.56	3.46	3.37	3.23	3.09	2.94	2.86	2.78	2.69	2.61	2.52	2.42
21	8.02	5.78	4.87	4.37	4.04	3.81	3.64	3.51	3.40	3.31	3.17	3.03	2.88	2.80	2.72	2.64	2.55	2.46	2.36
22	7.95	5.72	4.82	4.31	3.99	3.76	3.59	3.45	3.35	3.26	3.12	2.98	2.83	2.75	2.67	2.58	2.50	2.40	2.31
23	7.88	5.66	4.76	4.26	3.94	3.71	3.54	3.41	3.30	3.21	3.07	2.93	2.78	2.70	2.62	2.54	2.45	2.35	2.26
24	7.82	5.61	4.72	4.22	3.90	3.67	3.50	3.36	3.26	3.17	3.03	2.89	2.74	2.66	2.58	2.49	2.40	2.31	2.21
25	7.77	5.57	4.68	4.18	3.85	3.63	3.46	3.32	3.22	3.13	2.99	2.85	2.70	2.62	2.54	2.45	2.36	2.27	2.17
26	7.72	5.53	4.64	4.14	3.82	3.59	3.42	3.29	3.18	3.09	2.96	2.81	2.66	2.58	2.50	2.42	2.33	2.23	2.13
27	7.68	5.49	4.60	4.11	3.78	3.56	3.39	3.26	3.15	3.06	2.93	2.78	2.63	2.55	2.47	2.38	2.29	2.20	2.10
28	7.64	5.45	4.57	4.07	3.75	3.53	3.36	3.23	3.12	3.03	2.90	2.75	2.60	2.52	2.44	2.35	2.26	2.17	2.06
29	7.60	5.42	4.54	4.04	3.73	3.50	3.33	3.20	3.09	3.00	2.87	2.73	2.57	2.49	2.41	2.33	2.23	2.14	2.03
30	7.56	5.39	4.51	4.02	3.70	3.47	3.30	3.17	3.07	2.98	2.84	2.70	2.55	2.47	2.39	2.30	2.21	2.11	2.01
40	7.31	5.18	4.31	3.83	3.51	3.29	3.12	2.99	2.89	2.80	2.66	2.52	2.37	2.29	2.20	2.11	2.02	1.92	1.80
60	7.08	4.98	4.13	3.65	3.34	3.12	2.95	2.82	2.72	2.63	2.50	2.35	2.20	2.12	2.03	1.94	1.84	1.73	1.60
120	6.85	4.79	3.95	3.48	3.17	2.96	2.79	2.66	2.56	2.47	2.34	2.19	2.03	1.95	1.86	1.76	1.66	1.53	1.38
∞	6.63	4.61	3.78	3.32	3.02	2.80	2.64	2.51	2.41	2.32	2.18	2.04	1.88	1.79	1.70	1.59	1.47	1.32	1.00

Source: Adapted with permission from *Biometrika Tables for Statisticians*, Vol. 1, 3rd ed., 1966, by E. S. Pearson and H. O. Hartley, Cambridge University Press, Cambridge.

TABLE A.5 Orthogonal Polynomials

X_j	$n=3$		$n=4$		$n=5$		$n=6$		$n=7$		$\sum_{j=1}^n \{P_j(X_j)\}^2$							
	P_1	P_2	P_1	P_2	P_1	P_2	P_1	P_2	P_1	P_2		P_3	P_4	P_5	P_6			
1	-1	1	-3	1	-1	2	-1	1	-5	5	-1	1	-3	5	-1	3	-1	1
2	0	-2	-1	-1	3	-1	2	-4	-3	-1	7	-3	5	0	1	-7	4	-6
3	1	1	1	-1	-3	0	-2	0	6	-1	4	2	-10	-1	-3	1	1	-5
4			3	1	1	1	-1	-2	-4	1	-4	2	10	0	-4	0	6	0
5						2	2	1	1	3	-1	-7	-3	-5	1	-3	-1	1
6									5	5	5	1	1	2	0	-1	-7	-4
7										5	5	1	1	3	5	1	3	1
λ	2	6	20	4	20	10	14	10	70	84	180	28	252	28	84	6	154	84
	1	3	2	1	$\frac{10}{3}$	1	1	$\frac{5}{6}$	2	$\frac{3}{2}$	$\frac{5}{3}$	$\frac{7}{12}$	$\frac{21}{10}$	1	1	$\frac{1}{6}$	$\frac{7}{12}$	$\frac{7}{20}$
X_j	$n=8$		$n=8$		$n=9$		$n=9$		$n=10$		$\sum_{j=1}^n \{P_j(X_j)\}^2$							
	P_1	P_2	P_3	P_4	P_5	P_6	P_1	P_2	P_3	P_4		P_5	P_6	P_1	P_2	P_3	P_4	P_5
1	-7	7	-7	7	-7	1	-4	28	-14	14	-4	4	-9	6	-42	18	-6	3
2	-5	1	5	-13	23	-5	-3	7	7	-21	11	-17	-7	2	14	-22	14	-11
3	-3	-3	7	-3	-17	9	-2	-8	13	-11	-4	22	-5	-5	35	-17	-1	10
4	-1	-5	3	9	-15	-5	-1	-17	9	9	-9	1	-3	-3	31	3	-11	6
5	1	-5	-3	9	15	-5	0	-20	0	18	0	-20	-1	-4	12	18	-6	-8
6	3	-3	-7	-3	17	9	1	-17	-9	9	9	1	1	-4	-12	18	6	-8
7	5	1	-5	-13	-23	-5	2	-8	-13	-11	4	22	3	-3	-31	3	11	6
8	7	7	7	7	7	1	3	7	-7	-21	-11	-17	5	-1	-35	-17	1	10
9						4	4	28	14	14	4	4	7	2	-14	-22	-14	-11
10													9	6	42	18	6	3
λ	2	1	$\frac{2}{3}$	$\frac{7}{12}$	$\frac{7}{10}$	$\frac{11}{60}$	1	3	$\frac{5}{6}$	$\frac{7}{12}$	$\frac{3}{20}$	$\frac{11}{60}$	2	$\frac{1}{2}$	$\frac{5}{3}$	$\frac{5}{12}$	$\frac{1}{10}$	$\frac{11}{240}$

Source: Adapted with permission from *Biometrika Tables for Statisticians*, Vol. 1, 3rd ed., 1966, by E. S. Pearson and H. O. Hartley, Cambridge University Press. Cambridge.

TABLE A.6 Critical Values of the Durbin—Watson Statistic

Sample Size	Probability in Lower Tail (Significance Level = α)	$k =$ Number of Regressors (Excluding the Intercept)									
		1		2		3		4		5	
		d_L	d_U	d_L	d_U	d_L	d_U	d_L	d_U	d_L	d_U
15	.01	.81	1.07	.70	1.25	.59	1.46	.49	1.70	.39	1.96
	.025	.95	1.23	.83	1.40	.71	1.61	.59	1.84	.48	2.09
	.05	1.08	1.36	.95	1.54	.82	1.75	.69	1.97	.56	2.21
20	.01	.95	1.15	.86	1.27	.77	1.41	.63	1.57	.60	1.74
	.025	1.08	1.28	.99	1.41	.89	1.55	.79	1.70	.70	1.87
	.05	1.20	1.41	1.10	1.54	1.00	1.68	.90	1.83	.79	1.99
25	.01	1.05	1.21	.98	1.30	.90	1.41	.83	1.52	.75	1.65
	.025	1.13	1.34	1.10	1.43	1.02	1.54	.94	1.65	.86	1.77
	.05	1.20	1.45	1.21	1.55	1.12	1.66	1.04	1.77	.95	1.89
30	.01	1.13	1.26	1.07	1.34	1.01	1.42	.94	1.51	.88	1.61
	.025	1.25	1.38	1.18	1.46	1.12	1.54	1.05	1.63	.98	1.73
	.05	1.35	1.49	1.28	1.57	1.21	1.65	1.14	1.74	1.07	1.83
40	.01	1.25	1.34	1.20	1.40	1.15	1.46	1.10	1.52	1.05	1.58
	.025	1.35	1.45	1.30	1.51	1.25	1.57	1.20	1.63	1.15	1.69
	.05	1.44	1.54	1.39	1.60	1.34	1.66	1.29	1.72	1.23	1.79
50	.01	1.32	1.40	1.28	1.45	1.24	1.49	1.20	1.54	1.16	1.59
	.025	1.42	1.50	1.38	1.54	1.34	1.59	1.30	1.64	1.26	1.69
	.05	1.50	1.59	1.46	1.63	1.42	1.67	1.38	1.72	1.34	1.77
60	.01	1.38	1.45	1.35	1.48	1.32	1.52	1.28	1.56	1.25	1.60
	.025	1.47	1.54	1.44	1.57	1.40	1.61	1.37	1.65	1.33	1.69
	.05	1.55	1.62	1.51	1.65	1.48	1.69	1.44	1.73	1.41	1.77
80	.01	1.47	1.52	1.44	1.54	1.42	1.57	1.39	1.60	1.36	1.62
	.025	1.54	1.59	1.52	1.62	1.49	1.65	1.47	1.67	1.44	1.70
	.05	1.61	1.66	1.59	1.69	1.56	1.72	1.53	1.74	1.51	1.77
100	.01	1.52	1.56	1.50	1.58	1.48	1.60	1.45	1.63	1.44	1.65
	.025	1.59	1.63	1.57	1.65	1.55	1.67	1.53	1.70	1.51	1.72
	.05	1.65	1.69	1.63	1.72	1.61	1.74	1.59	1.76	1.57	1.78

Source: Adapted from "Testing for Serial Correlation in Least Squares Regression II," by J. Durbin and G. S. Watson, *Biometrika*, Vol. 38, 1951, with permission of the publisher.

APPENDIX B

DATA SETS FOR EXERCISES

Table B.1	National Football League 1976 Team Performance
Table B.2	Solar Thermal Energy Test Data
Table B.3	Gasoline Mileage Performance for 32 Automobiles
Table B.4	Property Valuation Data
Table B.5	Belle Ayr Liquefaction Runs
Table B.6	Tube-Flow Reactor Data
Table B.7	Oil Extraction from Peanuts Data
Table B.8	Clathrate Formation Data
Table B.9	Pressure Drop Data
Table B.10	Kinematic Viscosity Data
Table B.11	Wine Quality Data
Table B.12	Heat Treating Data
Table B.13	Jet Turbine Engine Thrust Data
Table B.14	Electronic Inverter Data
Table B.15	Air Pollution and Mortality Data
Table B.16	Life Expectancy Data
Table B.17	Patient Satisfaction Data
Table B.18	Fuel Consumption Data
Table B.19	Wine Quality of Young Red Wines
Table B.20	Methanol Oxidation in Supercritical Water
Table B.21	Hard Cement Data

TABLE B.1 National Football League 1976 Team Performance

Team	y	x_1	x_2	x_3	x_4	x_5	x_6	x_7	x_8	x_9
Washington	10	2113	1985	38.9	64.7	+4	868	59.7	2205	1917
Minnesota	11	2003	2855	38.8	61.3	+3	615	55.0	2096	1575
New England	11	2957	1737	40.1	60.0	+14	914	65.6	1847	2175
Oakland	13	2285	2905	41.6	45.3	-4	957	61.4	1903	2476
Pittsburgh	10	2971	1666	39.2	53.8	+15	836	66.1	1457	1866
Baltimore	11	2309	2927	39.7	74.1	+8	786	61.0	1848	2339
Los Angeles	10	2528	2341	38.1	65.4	+12	754	66.1	1564	2092
Dallas	11	2147	2737	37.0	78.3	-1	761	58.0	1821	1909
Atlanta	4	1689	1414	42.1	47.6	-3	714	57.0	2577	2001
Buffalo	2	2566	1838	42.3	54.2	-1	797	58.9	2476	2254
Chicago	7	2363	1480	37.3	48.0	+19	984	67.5	1984	2217
Cincinnati	10	2109	2191	39.5	51.9	+6	700	57.2	1917	1758
Cleveland	9	2295	2229	37.4	53.6	-5	1037	58.8	1761	2032
Denver	9	1932	2204	35.1	71.4	+3	986	58.6	1709	2025
Detroit	6	2213	2140	38.8	58.3	+6	819	59.2	1901	1686
Green Bay	5	1722	1730	36.6	52.6	-19	791	54.4	2288	1835
Houston	5	1498	2072	35.3	59.3	-5	776	49.6	2072	1914
Kansas City	5	1873	2929	41.1	55.3	+10	789	54.3	2861	2496
Miami	6	2118	2268	38.2	69.6	+6	582	58.7	2411	2670
New Orleans	4	1775	1983	39.3	78.3	+7	901	51.7	2289	2202
New York Giants	3	1904	1792	39.7	38.1	-9	734	61.9	2203	1988
New York Jets	3	1929	1606	39.7	68.8	-21	627	52.7	2592	2324
Philadelphia	4	2080	1492	35.5	68.8	-8	722	57.8	2053	2550
St. Louis	10	2301	2835	35.3	74.1	+2	683	59.7	1979	2110
San Diego	6	2040	2416	38.7	50.0	0	576	54.9	2048	2628
San Francisco	8	2447	1638	39.9	57.1	-8	848	65.3	1786	1776
Seattle	2	1416	2649	37.4	56.3	-22	684	43.8	2876	2524
Tampa Bay	0	1503	1503	39.3	47.0	-9	875	53.5	2560	2241

y : Games won (per 14-game season)

x_1 : Rushing yards (season)

x_2 : Passing yards (season)

x_3 : Punting average (yards/punt)

x_4 : Field goal percentage (FGs made/FGs attempted 2season)

x_5 : Turnover differential (turnovers acquired–turnovers lost)

x_6 : Penalty yards (season)

x_7 : Percent rushing (rushing plays/total plays)

x_8 : Opponents' rushing yards (season)

x_9 : Opponents' passing yards (season)

TABLE B.2 Solar Thermal Energy Test Data

y	x_1	x_2	x_3	x_4	x_5
271.8	783.35	33.53	40.55	16.66	13.20
264.0	748.45	36.50	36.19	16.46	14.11
238.8	684.45	34.66	37.31	17.66	15.68
230.7	827.80	33.13	32.52	17.50	10.53
251.6	860.45	35.75	33.71	16.40	11.00
257.9	875.15	34.46	34.14	16.28	11.31
263.9	909.45	34.60	34.85	16.06	11.96
266.5	905.55	35.38	35.89	15.93	12.58
229.1	756.00	35.85	33.53	16.60	10.66
239.3	769.35	35.68	33.79	16.41	10.85
258.0	793.50	35.35	34.72	16.17	11.41
257.6	801.65	35.04	35.22	15.92	11.91
267.3	819.65	34.07	36.50	16.04	12.85
267.0	808.55	32.20	37.60	16.19	13.58
259.6	774.95	34.32	37.89	16.62	14.21
240.4	711.85	31.08	37.71	17.37	15.56
227.2	694.85	35.73	37.00	18.12	15.83
196.0	638.10	34.11	36.76	18.53	16.41
278.7	774.55	34.79	34.62	15.54	13.10
272.3	757.90	35.77	35.40	15.70	13.63
267.4	753.35	36.44	35.96	16.45	14.51
254.5	704.70	37.82	36.26	17.62	15.38
224.7	666.80	35.07	36.34	18.12	16.10
181.5	568.55	35.26	35.90	19.05	16.73
227.5	653.10	35.56	31.84	16.51	10.58
253.6	704.05	35.73	33.16	16.02	11.28
263.0	709.60	36.46	33.83	15.89	11.91
265.8	726.90	36.26	34.89	15.83	12.65
263.8	697.15	37.20	36.27	16.71	14.06

y : Total heat flux (kwatts)

x_1 : Insolation (watts/m²)

x_2 : Position of focal point in east direction (inches)

x_3 : Position of focal point in south direction (inches)

x_4 : Position of focal point in north direction (inches)

x_5 : Time of day

TABLE B.3 Gasoline Mileage Performance for 32 Automobiles

Automobile	y	x_1	x_2	x_3	x_4	x_5	x_6	x_7	x_8	x_9	x_{10}	x_{11}
Apollo	18.90	350	165	260	8.0:1	2.56:1	4	3	200.3	69.9	3910	A
Omega	17.00	350	170	275	8.5:1	2.56:1	4	3	199.6	72.9	2860	A
Nova	20.00	250	105	185	8.25:1	2.73:1	1	3	196.7	72.2	3510	A
Monarch	18.25	351	143	255	8.0:1	3.00:1	2	3	199.9	74.0	3890	A
Duster	20.07	225	95	170	8.4:1	2.76:1	1	3	194.1	71.8	3365	M
Jenson Conv.	11.2	440	215	330	8.2:1	2.88:1	4	3	184.5	69	4215	A
Skyhawk	22.12	231	110	175	8.0:1	2.56:1	2	3	179.3	65.4	3020	A
Monza	21.47	262	110	200	8.5:1	2.56:1	2	3	179.3	65.4	3180	A
Scirocco	34.70	89.7	70	81	8.2:1	3.90:1	2	4	155.7	64	1905	M
Corolla SR-5	30.40	96.9	75	83	9.0:1	4.30:1	2	5	165.2	65	2320	M
Camaro	16.50	350	155	250	8.5:1	3.08:1	4	3	195.4	74.4	3885	A
Datsun B210	36.50	85.3	80	83	8.5:1	3.89:1	2	4	160.6	62.2	2009	M
Capri II	21.50	171	109	146	8.2:1	3.22:1	2	4	170.4	66.9	2655	M
Pacer	19.70	258	110	195	8.0:1	3.08:1	1	3	171.5	77	3375	A
Babcat	20.30	140	83	109	8.4:1	3.40:1	2	4	168.8	69.4	2700	M
Granada	17.80	302	129	220	8.0:1	3.0:1	2	3	199.9	74	3890	A
Eldorado	14.39	500	190	360	8.5:1	2.73:1	4	3	224.1	79.8	5290	A
Imperial	14.89	440	215	330	8.2:1	2.71:1	4	3	231.0	79.7	5185	A
Nova LN	17.80	350	155	250	8.5:1	3.08:1	4	3	196.7	72.2	3910	A
Valiant	16.41	318	145	255	8.5:1	2.45:1	2	3	197.6	71	3660	A
Starfire	23.54	231	110	175	8.0:1	2.56:1	2	3	179.3	65.4	3050	A
Cordoba	21.47	360	180	290	8.4:1	2.45:1	2	3	214.2	76.3	4250	A
Trans AM	16.59	400	185	NA	7.6:1	3.08:1	4	3	196	73	3850	A
Corolla E-5	31.90	96.9	75	83	9.0:1	4.30:1	2	5	165.2	61.8	2275	M
Astre	29.40	140	86	NA	8.0:1	2.92:1	2	4	176.4	65.4	2150	M
Mark IV	13.27	460	223	366	8.0:1	3.00:1	4	3	228	79.8	5430	A
Celica GT	23.90	133.6	96	120	8.4:1	3.91:1	2	5	171.5	63.4	2535	M
Charger SE	19.73	318	140	255	8.5:1	2.71:1	2	3	215.3	76.3	4370	A
Cougar	13.90	351	148	243	8.0:1	3.25:1	2	3	215.5	78.5	4540	A
Elite	13.27	351	148	243	8.0:1	3.26:1	2	3	216.1	78.5	4715	A
Matador	13.77	360	195	295	8.25:1	3.15:1	4	3	209.3	77.4	4215	A
Corvette	16.50	350	165	255	8.5:1	2.73:1	4	3	185.2	69	3660	A

y: Miles/gallon

 x_1 : Displacement (cubic in.) x_2 : Horsepower (ft-lb) x_3 : Torque (ft-lb) x_4 : Compression ratio x_5 : Rear axle ratio x_6 : Carburetor (barrels) x_7 : No. of transmission speeds x_8 : Overall length (in.) x_9 : Width (in.) x_{10} : Weight (lb) x_{11} : Type of transmission (A automatic; M manual)Source: *Motor Trend*, 1975.

TABLE B.4 Property Valuation Data

y	x_1	x_2	x_3	x_4	x_5	x_6	x_7	x_8	x_9
25.9	4.9176	1.0	3.4720	0.9980	1.0	7	4	42	0
29.5	5.0208	1.0	3.5310	1.5000	2.0	7	4	62	0
27.9	4.5429	1.0	2.2750	1.1750	1.0	6	3	40	0
25.9	4.5573	1.0	4.0500	1.2320	1.0	6	3	54	0
29.9	5.0597	1.0	4.4550	1.1210	1.0	6	3	42	0
29.9	3.8910	1.0	4.4550	0.9880	1.0	6	3	56	0
30.9	5.8980	1.0	5.8500	1.2400	1.0	7	3	51	1
28.9	5.6039	1.0	9.5200	1.5010	0.0	6	3	32	0
35.9	5.8282	1.0	6.4350	1.2250	2.0	6	3	32	0
31.5	5.3003	1.0	4.9883	1.5520	1.0	6	3	30	0
31.0	6.2712	1.0	5.5200	0.9750	1.0	5	2	30	0
30.9	5.9592	1.0	6.6660	1.1210	2.0	6	3	32	0
30.0	5.0500	1.0	5.0000	1.0200	0.0	5	2	46	1
36.9	8.2464	1.5	5.1500	1.6640	2.0	8	4	50	0
41.9	6.6969	1.5	6.9020	1.4880	1.5	7	3	22	1
40.5	7.7841	1.5	7.1020	1.3760	1.0	6	3	17	0
43.9	9.0384	1.0	7.8000	1.5000	15	7	3	23	0
37.5	5.9894	1.0	5.5200	1.2560	2.0	6	3	40	1
37.9	7.5422	1.5	5.0000	1.6900	1.0	6	3	22	0
44.5	8.7951	1.5	9.8900	1.8200	2.0	8	4	50	1
37.9	6.0831	1.5	6.7265	1.6520	1.0	6	3	44	0
38.9	8.3607	1.5	9.1500	1.7770	2.0	8	4	48	1
36.9	8.1400	1.0	8.0000	1.5040	2.0	7	3	3	0
45.8	9.1416	1.5	7.3262	1.8310	1.5	8	4	31	0

y : Sale price of the house/1000

x_1 : Taxes (local, school, county)/1000

x_2 : Number of baths

x_3 : Lot size (sq ft \times 1000)

x_4 : Living space (sq ft \times 1000)

x_5 : Number of garage stalls

x_6 : Number of rooms

x_7 : Number of bedrooms

x_8 : Age of the home (years)

x_9 : Number of fireplaces

Source: "Prediction, Linear Regression and Minimum Sum of Relative Errors," by S. C. Narula and J. F. Wellington, *Technometrics*, **19**, 1977. Also see "Letter to the Editor," *Technometrics*, **22**, 1980.

TABLE B.5 Belle Ayr Liquefaction Runs

Run No.	y	x_1	x_2	x_3	x_4	x_5	x_6	x_7
1	36.98	5.1	400	51.37	4.24	1484.83	2227.25	2.06
2	13.74	26.4	400	72.33	30.87	289.94	434.90	1.33
3	10.08	23.8	400	71.44	33.01	320.79	481.19	0.97
4	8.53	46.4	400	79.15	44.61	164.76	247.14	0.62
5	36.42	7.0	450	80.47	33.84	1097.26	1645.89	0.22
6	26.59	12.6	450	89.90	41.26	605.06	907.59	0.76
7	19.07	18.9	450	91.48	41.88	405.37	608.05	1.71
8	5.96	30.2	450	98.6	70.79	253.70	380.55	3.93
9	15.52	53.8	450	98.05	66.82	142.27	213.40	1.97
10	56.61	5.6	400	55.69	8.92	1362.24	2043.36	5.08
11	26.72	15.1	400	66.29	17.98	507.65	761.48	0.60
12	20.80	20.3	400	58.94	17.79	377.60	566.40	0.90
13	6.99	48.4	400	74.74	33.94	158.05	237.08	0.63
14	45.93	5.8	425	63.71	11.95	130.66	1961.49	2.04
15	43.09	11.2	425	67.14	14.73	682.59	1023.89	1.57
16	15.79	27.9	425	77.65	34.49	274.20	411.30	2.38
17	21.60	5.1	450	67.22	14.48	1496.51	2244.77	0.32
18	35.19	11.7	450	81.48	29.69	652.43	978.64	0.44
19	26.14	16.7	450	83.88	26.33	458.42	687.62	8.82
20	8.60	24.8	450	89.38	37.98	312.25	468.28	0.02
21	11.63	24.9	450	79.77	25.66	307.08	460.62	1.72
22	9.59	39.5	450	87.93	22.36	193.61	290.42	1.88
23	4.42	29.0	450	79.50	21.52	155.96	233.95	1.43
24	38.89	5.5	460	72.73	17.86	1392.08	2088.12	1.35
25	11.19	11.5	450	77.88	25.20	663.09	994.63	1.61
26	75.62	5.2	470	75.50	8.66	1464.11	2196.17	4.78
27	36.03	10.6	470	83.15	22.39	720.07	1080.11	5.88

y: CO₂ x_1 : Space time, min. x_2 : Temperature, °C x_3 : Percent solvation x_4 : Oil yield (g/100 g MAF) x_5 : Coal total x_6 : Solvent total x_7 : Hydrogen consumption

Source: "Belle Ayr Liquefaction Runs with Solvent," *Industrial Chemical Process Design Development*, **17**, No. 3, 1978.

TABLE B.6 Tube-Flow Reactor Data

Run No.	y	x_1	x_2	x_3	x_4
1	0.000450	0.0105	90.9	0.0164	0.0177
2	0.000450	0.0110	84.6	0.0165	0.0172
3	0.000473	0.0106	88.9	0.0164	0.0157
4	0.000507	0.0116	488.7	0.0187	0.0082
5	0.000457	0.0121	454.4	0.0187	0.0070
6	0.000452	0.0123	439.2	0.0187	0.0065
7	0.000453	0.0122	447.1	0.0186	0.0071
8	0.000426	0.0122	451.6	0.0187	0.0062
9	0.001215	0.0123	487.8	0.0192	0.0153
10	0.001256	0.0122	467.6	0.0192	0.0129
11	0.001145	0.0094	95.4	0.0163	0.0354
12	0.001085	0.0100	87.1	0.0162	0.0342
13	0.001066	0.0101	82.7	0.0162	0.0323
14	0.001111	0.0099	87.0	0.0163	0.0337
15	0.001364	0.0110	516.4	0.0190	0.0161
16	0.001254	0.0117	488.0	0.0189	0.0149
17	0.001396	0.0110	534.5	0.0189	0.0163
18	0.001575	0.0104	542.3	0.0189	0.0164
19	0.001615	0.0067	98.8	0.0163	0.0379
20	0.001733	0.0066	84.8	0.0162	0.0360
21	0.002753	0.0044	69.6	0.0163	0.0327
22	0.003186	0.0073	436.9	0.0189	0.0263
23	0.003227	0.0078	406.3	0.0192	0.0200
24	0.003469	0.0067	447.9	0.0192	0.0197
25	0.001911	0.0091	58.5	0.0164	0.0331
26	0.002588	0.0079	394.3	0.0177	0.0674
27	0.002635	0.0068	461.0	0.0174	0.0770
28	0.002725	0.0065	469.2	0.0173	0.0780

y : NbOCl_3 concentration (g-mol/l)

x_1 : COCl_2 concentration (g-mol/l)

x_2 : Space time (sec)

x_3 : Molar density (g-mol/l)

x_4 : Mole fraction CO_2

Source: "Kinetics of Chlorination of Niobium Oxychloride by Phosgene in a Tube-Flow Reactor," *Industrial and Engineering Chemistry, Process Design Development*, **11**, No. 2, 1972.

TABLE B.7 Oil Extraction from Peanuts Data

Pressure (bars)	Temp. (°C)	Moisture (% by weight)	Flow Rate (L/min)	Particle Size (mm)	Yield
415	25	5	40	1.28	63
550	25	5	40	4.05	21
415	95	5	40	4.05	36
550	95	5	40	1.28	99
415	25	15	40	4.05	24
550	25	15	40	1.28	66
415	95	15	40	1.28	71
550	95	15	40	4.05	54
415	25	5	60	4.05	23
550	25	5	60	1.28	74
415	95	5	60	1.28	80
550	95	5	60	4.05	33
415	25	15	60	1.28	63
550	25	15	60	4.05	21
415	95	15	60	4.05	44
550	95	15	60	1.28	96

Source: "An Application of Fractional Experimental Designs," by M. B. Kilgo, *Quality Engineering*, **1**, pp. 19–23.

TABLE B.8 Clathrate Formation Data

x_1	x_2	y	x_1	x_2	y
0	10	7.5	0.02	30	19
0	50	15	0.02	60	26.4
0	85	22	0.02	90	28.5
0	110	28.6	0.02	120	29
0	140	31.6	0.02	210	35
0	170	34	0.02	30	15.1
0	200	35	0.02	60	26.4
0	230	35.5	0.02	120	27
0	260	36.5	0.02	150	29
0	290	38.5	0.05	20	21
0	10	12.3	0.05	40	27.3
0	30	18	0.05	130	48.5
0	62	20.8	0.05	190	50.4
0	90	25.7	0.05	250	52.5
0	150	32.5	0.05	60	34.4
0	210	34	0.05	90	46.5
0	270	35	0.05	120	50
0.02	10	14.4	0.05	150	51.9

y : Clathrate formation (mass %)

x_1 : Amount of surfactant (mass %)

x_2 : Time (minutes)

Source: "Study on a Cool Storage System Using HCFC (Hydro-chloro-fluoro-carbon)-14 lb (1,1-dichloro-1-fluoro-ethane) Clathrate," by T. Tanii, M. Minemoto, K. Nakazawa, and Y. Ando, *Canadian Journal of Chemical Engineering*, **75**, 353–360.

TABLE B.9 Pressure Drop Data

x_1	x_2	x_3	x_4	y
2.14	10	034	1	28.9
4.14	10	0.34	1	31
8.15	10	0.34	1	26.4
2.14	10	0.34	0.246	27.2
4.14	10	0.34	0.379	26.1
8.15	10	0.34	0.474	23.2
2.14	10	0.34	0.141	19.7
4.14	10	0.34	0.234	22.1
8.15	10	0.34	0.311	22.8
2.14	10	0.34	0.076	29.2
4.14	10	0.34	0.132	23.6
8.15	10	0.34	0.184	23.6
2.14	2.63	0.34	0.679	24.2
4.14	2.63	0.34	0.804	22.1
8.15	2.63	0.34	0.89	20.9
2.14	2.63	0.34	0.514	17.6
4.14	2.63	0.34	0.672	15.7
8.15	2.63	0.34	0.801	15.8
2.14	2.63	0.34	0.346	14
4.14	2.63	0.34	0.506	17.1
8.15	2.63	0.34	0.669	18.3
2.14	2.63	0.34	1	33.8
4.14	2.63	0.34	1	31.7
8.15	2.63	0.34	1	28.1
5.6	1.25	0.34	0.848	18.1
5.6	1.25	0.34	0.737	16.5
5.6	1.25	0.34	0.651	15.4
5.6	1.25	0.34	0.554	15
4.3	2.63	0.34	0.748	19.1
4.3	2.63	0.34	0.682	16.2
4.3	2.63	0.34	0.524	16.3
4.3	2.63	0.34	0.472	15.8
4.3	2.63	0.34	0.398	15.4
5.6	10.1	0.25	0.789	19.2
5.6	10.1	0.25	0.677	8.4
5.6	10.1	0.25	0.59	15
5.6	10.1	0.25	0.523	12
5.6	10.1	0.34	0.789	21.9
5.6	10.1	0.34	0.677	21.3
5.6	10.1	0.34	0.59	21.6
5.6	10.1	0.34	0.523	19.8
4.3	10.1	0.34	0.741	21.6
4.3	10.1	0.34	0.617	17.3
4.3	10.1	0.34	0.524	20
4.3	10.1	0.34	0.457	18.6
2.4	10.1	0.34	0.615	22.1
2.4	10.1	0.34	0.473	14.7
2.4	10.1	0.34	0.381	15.8
2.4	10.1	0.34	0.32	13.2

(Continued)

TABLE B.9 (Continued)

x_1	x_2	x_3	x_4	y
5.6	10.1	0.55	0.789	30.8
5.6	10.1	0.55	0.677	27.5
5.6	10.1	0.55	0.59	25.2
5.6	10.1	0.55	0.523	22.8
2.14	112	0.34	0.68	41.7
4.14	112	0.34	0.803	33.7
8.15	112	0.34	0.889	29.7
2.14	112	0.34	0.514	41.8
4.14	112	0.34	0.672	37.1
8.15	112	0.34	0.801	40.1
2.14	112	0.34	0.306	42.7
4.14	112	0.34	0.506	48.6
8.15	112	0.34	0.668	42.4

y : Dimensionless factor for the pressure drop through a bubble cap

x_1 : Superficial fluid velocity of the gas (cm/s)

x_2 : Kinematic viscosity

x_3 : Mesh opening (cm)

x_4 : Dimensionless number relating the superficial fluid velocity of the gas to the superficial fluid velocity of the liquid

Source: "A Correlation of Two-Phase Pressure Drops in Screen-plate Bubble Column," by C. H. Liu, M. Kan, and B. H. Chen, *Canadian Journal of Chemical Engineering*, **71**, 460–463.

TABLE B.10 Kinematic Viscosity Data

x_1	x_2	y
0.9189	-10	3.128
0.9189	0	2.427
0.9189	10	1.94
0.9189	20	1.586
0.9189	30	1.325
0.9189	40	1.126
0.9189	50	0.9694
0.9189	60	0.8473
0.9189	70	0.7481
0.9189	80	0.6671
0.7547	-10	2.27
0.7547	0	1.819
0.7547	10	1.489
0.7547	20	1.246
0.7547	30	1.062
0.7547	40	0.916
0.7547	50	0.8005
0.7547	60	0.7091
0.7547	70	0.6345
0.7547	80	0.5715
0.5685	-10	1.593
0.5685	0	1.324
0.5685	10	1.118
0.5685	20	0.9576
0.5685	30	0.8302
0.5685	40	0.7282
0.5685	50	0.647
0.5685	60	0.5784
0.5685	70	0.5219
0.5685	80	0.4735
0.361	-10	1.161
0.361	0	0.9925
0.361	10	0.8601
0.361	20	0.7523
0.361	30	0.6663
0.361	40	0.594
0.361	50	0.5338
0.361	60	0.4804
0.361	70	0.4361
0.361	80	0.4016

y : Kinematic viscosity (10^{-6} m²/s).

x_1 : Ratio of 2-methoxyethanol to 1,2-dimethoxyethane (dimensionless).

x_2 : Temperature (°C).

Source: "Viscosimetric Studies on 2-Methoxyethanol + 1, 2-Dimethoxyethane Binary Mixtures from -10 to 80°C," *Canadian Journal of Chemical Engineering*, **75**, 494-501.

TABLE B.11 Wine Quality Data (Found in Minitab)

Clarity, x_1	Aroma, x_2	Body, x_3	Flavor, x_4	Oakiness, x_5	Quality, y	Region
1	3.3	2.8	3.1	4.1	9.8	1
1	4.4	4.9	3.5	3.9	12.6	1
1	3.9	5.3	4.8	4.7	11.9	1
1	3.9	2.6	3.1	3.6	11.1	1
1	5.6	5.1	5.5	5.1	13.3	1
1	4.6	4.7	5	4.1	12.8	1
1	4.8	4.8	4.8	3.3	12.8	1
1	5.3	4.5	4.3	5.2	12	1
1	4.3	4.3	3.9	2.9	13.6	3
1	4.3	3.9	4.7	3.9	13.9	1
1	5.1	4.3	4.5	3.6	14.4	3
0.5	3.3	5.4	4.3	3.6	12.3	2
0.8	5.9	5.7	7	4.1	16.1	3
0.7	7.7	6.6	6.7	3.7	16.1	3
1	7.1	4.4	5.8	4.1	15.5	3
0.9	5.5	5.6	5.6	4.4	15.5	3
1	6.3	5.4	4.8	4.6	13.8	3
1	5	5.5	5.5	4.1	13.8	3
1	4.6	4.1	4.3	3.1	11.3	1
0.9	3.4	5	3.4	3.4	7.9	2
0.9	6.4	5.4	6.6	4.8	15.1	3
1	5.5	5.3	5.3	3.8	13.5	3
0.7	4.7	4.1	5	3.7	10.8	2
0.7	4.1	4	4.1	4	9.5	2
1	6	5.4	5.7	4.7	12.7	3
1	4.3	4.6	4.7	4.9	11.6	2
1	3.9	4	5.1	5.1	11.7	1
1	5.1	4.9	5	5.1	11.9	2
1	3.9	4.4	5	4.4	10.8	2
1	4.5	3.7	2.9	3.9	8.5	2
1	5.2	4.3	5	6	10.7	2
0.8	4.2	3.8	3	4.7	9.1	1
1	3.3	3.5	4.3	4.5	12.1	1
1	6.8	5	6	5.2	14.9	3
0.8	5	5.7	5.5	4.8	13.5	1
0.8	3.5	4.7	4.2	3.3	12.2	1
0.8	4.3	5.5	3.5	5.8	10.3	1
0.8	5.2	4.8	5.7	3.5	13.2	1

The wine type here is Pinot Noir. Region refers to distinct geographic regions.

TABLE B.12 Heat Treating Data

Temp	Soaktime	Soakpct	Difftime	Diffpct	Pitch
1650	0.58	1.10	0.25	0.90	0.013
1650	0.66	1.10	0.33	0.90	0.016
1650	0.66	1.10	0.33	0.90	0.015
1650	0.66	1.10	0.33	0.95	0.016
1600	0.66	1.15	0.33	1.00	0.015
1600	0.66	1.15	0.33	1.00	0.016
1650	1.00	1.10	0.50	0.80	0.014
1650	1.17	1.10	0.58	0.80	0.021
1650	1.17	1.10	0.58	0.80	0.018
1650	1.17	1.10	0.58	0.80	0.019
1650	1.17	1.10	0.58	0.90	0.021
1650	1.17	1.10	0.58	0.90	0.019
1650	1.17	1.15	0.58	0.90	0.021
1650	1.20	1.15	1.10	0.80	0.025
1650	2.00	1.15	1.00	0.80	0.025
1650	2.00	1.10	1.10	0.80	0.026
1650	2.20	1.10	1.10	0.80	0.024
1650	2.20	1.10	1.10	0.80	0.025
1650	2.20	1.15	1.10	0.80	0.024
1650	2.20	1.10	1.10	0.90	0.025
1650	2.20	1.10	1.10	0.90	0.027
1650	2.20	1.10	1.50	0.90	0.026
1650	3.00	1.15	1.50	0.80	0.029
1650	3.00	1.10	1.50	0.70	0.030
1650	3.00	1.10	1.50	0.75	0.028
1650	3.00	1.15	1.66	0.85	0.032
1650	3.33	1.10	1.50	0.80	0.033
1700	4.00	1.10	1.50	0.70	0.039
1650	4.00	1.10	1.50	0.70	0.040
1650	4.00	1.15	1.50	0.85	0.035
1700	12.50	1.00	1.50	0.70	0.056
1700	18.50	1.00	1.50	0.70	0.068

y = PITCH: Results of the pitch carbon analysis test

TEMP: Furnace temperature

SOAKTIME: Duration of the carburizing cycle

SOAKPCT: Carbon concentration

DIFFTIME: Duration of the diffuse cycle

DIFFPCT: Carbon concentration of the diffuse cycle

TABLE B.13 Jet Turbine Engine Thrust Data

Observation Number	y	x_1	x_2	x_3	x_4	x_5	x_6
1	4540	2140	20640	30250	205	1732	99
2	4315	2016	20280	30010	195	1697	100
3	4095	1905	19860	29780	184	1662	97
4	3650	1675	18980	29330	164	1598	97
5	3200	1474	18100	28960	144	1541	97
6	4833	2239	20740	30083	216	1709	87
7	4617	2120	20305	29831	206	1669	87
8	4340	1990	19961	29604	196	1640	87
9	3820	1702	18916	29088	171	1572	85
10	3368	1487	18012	28675	149	1522	85
11	4445	2107	20520	30120	195	1740	101
12	4188	1973	20130	29920	190	1711	100
13	3981	1864	19780	29720	180	1682	100
14	3622	1674	19020	29370	161	1630	100
15	3125	1440	18030	28940	139	1572	101
16	4560	2165	20680	30160	208	1704	98
17	4340	2048	20340	29960	199	1679	96
18	4115	1916	19860	29710	187	1642	94
19	3630	1658	18950	29250	164	1576	94
20	3210	1489	18700	28890	145	1528	94
21	4330	2062	20500	30190	193	1748	101
22	4119	1929	20050	29960	183	1713	100
23	3891	1815	19680	29770	173	1684	100
24	3467	1595	18890	29360	153	1624	99
25	3045	1400	17870	28960	134	1569	100
26	4411	2047	20540	30160	193	1746	99
27	4203	1935	20160	29940	184	1714	99
28	3968	1807	19750	29760	173	1679	99
29	3531	1591	18890	29350	153	1621	99
30	3074	1388	17870	28910	133	1561	99
31	4350	2071	20460	30180	198	1729	102
32	4128	1944	20010	29940	186	1692	101
33	3940	1831	19640	29750	178	1667	101
34	3480	1612	18710	29360	156	1609	101
35	3064	1410	17780	28900	136	1552	101
36	4402	2066	20520	30170	197	1758	100
37	4180	1954	20150	29950	188	1729	99
38	3973	1835	19750	29740	178	1690	99
39	3530	1616	18850	29320	156	1616	99
40	3080	1407	17910	28910	137	1569	100

y : Thrust

x_1 : Primary speed of rotation

x_2 : Secondary speed of rotation

x_3 : Fuel flow rate

x_4 : Pressure

x_5 : Exhaust temperature

x_6 : Ambient temperature at time of test

TABLE B.14 Electronic Inverter Data

Observation Number	x_1	x_2	x_3	x_4	x_5	y
1	3	3	3	3	0	0.787
2	8	30	8	8	0	0.293
3	3	6	6	6	0	1.710
4	4	4	4	12	0	0.203
5	8	7	6	5	0	0.806
6	10	20	5	5	0	4.713
7	8	6	3	3	25	0.607
8	6	24	4	4	25	9.107
9	4	10	12	4	25	9.210
10	16	12	8	4	25	1.365
11	3	10	8	8	25	4.554
12	8	3	3	3	25	0.293
13	3	6	3	3	50	2.252
14	3	8	8	3	50	9.167
15	4	8	4	8	50	0.694
16	5	2	2	2	50	0.379
17	2	2	2	3	50	0.485
18	10	15	3	3	50	3.345
19	15	6	2	3	50	0.208
20	15	6	2	3	75	0.201
21	10	4	3	3	75	0.329
22	3	8	2	2	75	4.966
23	6	6	6	4	75	1.362
24	2	3	8	6	75	1.515
25	3	3	8	8	75	0.751

y : Transient point (volts) of PMOS-NMOS inverters

x_1 : Width of the NMOS device

x_2 : Length of the NMOS device

x_3 : Width of the PMOS device

x_4 : Length of the PMOS device

TABLE B.15 Air Pollution and Mortality Data

City	Mort	Precip	Educ	Nonwhite	Nox	SO ₂
San Jose, CA	790.73	13.00	12.20	3.00	32.00	3.00
Wichita, KS	823.76	28.00	12.10	7.50	2.00	1.00
San Diego, CA	839.71	10.00	12.10	5.90	66.00	20.00
Lancaster, PA	844.05	43.00	9.50	2.90	7.00	32.00
Minneapolis, MN	857.62	25.00	12.10	3.00	11.00	26.00
Dallas, TX	860.10	35.00	11.80	14.80	1.00	1.00
Miami, FL	861.44	60.00	11.50	11.50	1.00	1.00
Los Angeles, CA	861.83	11.00	12.10	7.80	319.00	130.00
Grand Rapids, MI	871.34	31.00	10.90	5.10	3.00	10.00
Denver, CO	871.77	15.00	12.20	4.70	8.00	28.00
Rochester, NY	874.28	32.00	11.10	5.00	4.00	18.00
Hartford, CT	887.47	43.00	11.50	7.20	3.00	10.00
Fort Worth, TX	891.71	31.00	11.40	11.50	1.00	1.00

(Continued)

TABLE B.15 (Continued)

City	Mort	Precip	Educ	Nonwhite	Nox	SO2
Portland, OR	893.99	37.00	12.00	3.60	21.00	44.00
Worcester, MA	895.70	45.00	11.10	1.00	3.00	8.00
Seattle, WA	899.26	35.00	12.20	5.70	7.00	20.00
Bridgeport, CT	899.53	45.00	10.60	5.30	4.00	4.00
Springfield, MA	904.16	45.00	11.10	3.40	4.00	20.00
San Francisco, CA	911.70	18.00	12.20	13.70	171.00	86.00
York, PA	911.82	42.00	9.00	4.80	8.00	49.00
Utica, NY	912.20	40.00	10.30	2.50	2.00	11.00
Canton, OH	912.35	36.00	10.70	6.70	7.00	20.00
Kansas City, MO	919.73	35.00	12.00	12.60	4.00	4.00
Akron, OH	921.87	36.00	11.40	8.80	15.00	59.00
New Haven, CT	923.23	46.00	11.30	8.80	3.00	8.00
Milwaukee, WI	929.15	30.00	11.10	5.80	23.00	125.00
Boston, MA	934.70	43.00	12.10	3.50	32.00	62.00
Dayton, OH	936.23	36.00	11.40	12.40	4.00	16.00
Providence, RI	938.50	42.00	10.10	2.20	4.00	18.00
Flint, MI	941.18	30.00	10.80	13.10	4.00	11.00
Reading, PA	946.18	41.00	9.60	2.70	11.00	89.00
Syracuse, NY	950.67	38.00	11.40	3.80	5.00	25.00
Houston, TX	952.53	46.00	11.40	21.00	5.00	1.00
Saint Louis, MO	953.56	34.00	9.70	17.20	15.00	68.00
Youngstown, OH	954.44	38.00	10.70	11.70	13.00	39.00
Columbus, OH	958.84	37.00	11.90	13.10	9.00	15.00
Detroit, MI	959.22	31.00	10.80	15.80	35.00	124.00
Nashville, TN	961.01	45.00	10.10	21.00	14.00	78.00
Allentown, PA	962.35	44.00	9.80	0.80	6.00	33.00
Washington, DC	967.80	41.00	12.30	25.90	28.00	102.00
Indianapolis, IN	968.66	39.00	11.40	15.60	7.00	33.00
Cincinnati, OH	970.47	40.00	10.20	13.00	26.00	146.00
Greensboro, NC	971.12	42.00	10.40	22.70	3.00	5.00
Toledo, OH	972.46	31.00	10.70	9.50	7.00	25.00
Atlanta, GA	982.29	47.00	11.10	27.10	8.00	24.00
Cleveland, OH	985.95	35.00	11.10	14.70	21.00	64.00
Louisville, KY	989.27	30.00	9.90	13.10	37.00	193.00
Pittsburgh, PA	991.29	36.00	10.60	8.10	59.00	263.00
New York, NY	994.65	42.00	10.70	11.30	26.00	108.00
Albany, NY	997.88	35.00	11.00	3.50	10.00	39.00
Buffalo, NY	1001.90	36.00	10.50	8.10	12.00	37.00
Wilmington, DE	1003.50	45.00	11.30	12.10	11.00	42.00
Memphis, TE	1006.49	50.00	10.40	36.70	18.00	34.00
Philadelphia, PA	1015.02	42.00	10.50	17.50	32.00	161.00
Chattanooga, TN	1017.61	52.00	9.60	22.20	8.00	27.00
Chicago, IL	1024.89	33.00	10.90	16.30	63.00	278.00
Richmond, VA	1025.50	44.00	11.00	28.60	9.00	48.00
Birmingham, AL	1030.38	53.00	10.20	38.50	32.00	72.00
Baltimore, MD	1071.29	43.00	9.60	24.40	38.00	206.00
New Orleans, LA	1113.06	54.00	9.70	31.40	17.00	1.00

TABLE B.16 Life Expectancy Data

Country	LifeExp	People- per-TV	People-per-Dr	LifeExpMale	LifeExpFemale
Argentina	70.5	4	370	74	67
Bangladesh	53.5	315	6,166	53	54
Brazil	65	4	684	68	62
Canada	76.5	1.7	449	80	73
China	70	8	643	72	68
Colombia	71	5.6	1,551	74	68
Egypt	60.5	15	616	61	60
Ethiopia	51.5	503	36,660	53	50
France	78	2.6	403	82	74
Germany	76	2.6	346	79	73
India	57.5	44	2,471	58	57
Indonesia	61	24	7,427	63	59
Iran	64.5	23	2,992	65	64
Italy	78.5	3.8	233	82	75
Japan	79	1.8	609	82	76
Kenya	61	96	7,615	63	59
Korea, North	70	90	370	73	67
Korea, South	70	4.9	1,066	73	67
Mexico	72	6.6	600	76	68
Morocco	64.5	21	4,873	66	63
Burma	54.5	592	3,485	56	53
Pakistan	56.5	73	2,364	57	56
Peru	64.5	14	1,016	67	62
Philippines	64.5	8.8	1,062	67	62
Poland	73	3.9	480	77	69
Romania	72	6	559	75	69
Russia	69	3.2	259	74	64
South Africa	64	11	1,340	67	61
Spain	78.5	2.6	275	82	75
Sudan	53	23	12,550	54	52
Taiwan	75	3.2	965	78	72
Thailand	68.5	11	4,883	73	66
Turkey	70	5	1,189	72	68
Ukraine	70.5	3	226	75	66
United Kingdom	76	3	611	79	73
United States	75.5	1.3	404	79	72
Venezuela	74.5	5.6	576	78	71
Vietnam	65	29	3,096	67	63

Table B.17 Patient Satisfaction Data

Satisfaction	Age	Severity	Surgical-Medical	Anxiety
68	55	50	0	2.1
77	46	24	1	2.8
96	30	46	1	3.3
80	35	48	1	4.5
43	59	58	0	2
44	61	60	0	5.1
26	74	65	1	5.5
88	38	42	1	3.2
75	27	42	0	3.1
57	51	50	1	2.4
56	53	38	1	2.2
88	41	30	0	2.1
88	37	31	0	1.9
102	24	34	0	3.1
88	42	30	0	3
70	50	48	1	4.2
82	58	61	1	4.6
43	60	71	1	5.3
46	62	62	0	7.2
56	68	38	0	7.8
59	70	41	1	7
26	79	66	1	6.2
52	63	31	1	4.1
83	39	42	0	3.5
75	49	40	1	2.1

TABLE B.18 Fuel Consumption Data

y	x_1	x_2	x_3	x_4	x_5	x_6	x_7	x_8
343	0	52.8	811.7	2.11	220	261	87	1.8
356	1	52.8	811.7	2.11	220	261	87	1.8
344	0	50.0	821.3	2.11	223	260	87	16.6
356	1	50.0	821.3	2.11	223	260	87	16.6
352	0	47.2	832.0	2.09	221	261	92	23.0
361	1	47.2	832.0	2.09	221	261	92	23.0
372	0	47.0	831.3	2.26	190	323	75	25.1
355	1	47.0	831.3	2.26	190	323	75	25.1
375	0	48.3	836.8	2.47	180	364	71	26.1
359	1	48.3	836.8	2.47	180	364	71	26.1
364	0	44.7	808.3	1.41	180	300	64	20.0
357	1	44.7	808.3	1.41	180	300	64	20.0
368	0	55.7	808.7	1.44	176	299	64	20.5
360	1	55.7	808.7	1.44	176	299	64	20.5
372	0	52.8	813.2	1.96	175	301	75	17.3
352	1	52.8	813.2	1.96	175	301	75	17.3

y : fuel consumption (g/km)

x_1 : vehicle (0—bus, 1—truck)

x_2 : cetane number

x_3 : density (g/L, 15°C)

x_4 : viscosity (KV, 40°C)

x_5 : initial boiling point (degrees C)

x_6 : final boiling point (degrees C)

x_7 : flash point (degrees C)

x_8 : total aromatics (percent)

Source: “A Multivariate Statistical Analysis of Fuel-Related Polycyclic Aromatic Hydrocarbon Emissions from Heavy-Duty Diesel Vehicles,” by R. Westerholm and H. Li, *Environmental Science and Technology*, **28**, 965–972.

TABLE B.19 Wine Quality of Young Red Wines

y	x_1	x_2	x_3	x_4	x_5	x_6	x_7	x_8	x_9	x_{10}
19.2	0	3.85	66	9.35	5.65	2.40	3.25	0.33	19	0.065
18.3	0	3.73	79	11.15	6.95	3.15	3.80	0.36	21	0.076
17.1	0	3.88	73	9.40	5.75	2.10	3.65	0.40	18	0.073
17.3	0	3.86	99	12.85	7.70	3.90	3.80	0.35	22	0.076
16.8	0	3.98	75	8.55	5.05	2.05	3.00	0.49	12	0.060
16.5	0	3.85	61	10.30	6.20	2.50	3.70	0.38	20	0.074
15.8	0	3.93	66	4.90	2.75	1.20	1.55	0.29	11	0.031
15.2	0	3.66	86	6.40	4.00	1.50	2.50	0.27	19	0.050
15.2	0	3.91	78	5.80	3.30	1.40	1.90	0.40	9	0.038
14.0	0	3.47	178	3.60	2.25	0.75	1.50	0.37	8	0.030
14.0	0	3.91	81	3.90	2.15	1.00	1.15	0.32	7	0.023
13.8	0	3.75	108	5.80	3.20	1.60	1.60	0.38	8	0.032
13.6	0	3.90	92	5.40	2.85	1.55	1.30	0.44	6	0.026
12.8	0	3.92	96	5.00	2.70	1.40	1.30	0.35	7	0.026
18.5	1	3.87	89	9.15	5.60	1.95	3.65	0.46	16	0.073
17.3	1	3.97	59	10.25	6.10	2.40	3.70	0.40	19	0.074
16.3	1	3.76	22	8.20	5.00	1.85	3.15	0.25	25	0.063
16.3	1	3.76	77	8.35	5.05	1.90	3.15	0.37	17	0.063
16.0	1	3.98	58	10.15	6.00	2.60	3.40	0.38	18	0.068
16.0	1	3.88	85	6.85	4.10	1.50	2.60	0.33	16	0.052
15.7	1	3.75	120	8.80	5.50	1.85	3.65	0.39	19	0.073
15.5	1	3.98	94	5.45	3.05	1.50	1.55	0.41	8	0.031
15.3	1	3.69	122	8.00	5.05	1.90	3.15	0.27	23	0.063
15.3	1	3.77	144	5.60	3.35	1.10	2.25	0.36	12	0.045
14.8	1	3.74	10	7.90	4.75	1.95	2.80	0.25	23	0.056
14.3	1	3.76	100	5.55	3.25	1.15	2.10	0.34	12	0.042
14.3	1	3.91	73	4.65	2.70	0.95	1.75	0.36	10	0.035
14.2	1	3.60	301	4.25	2.40	1.25	1.15	0.42	6	0.023
14.0	1	3.76	104	8.70	5.10	2.25	2.85	0.34	17	0.057
13.8	1	3.90	67	7.40	4.40	1.60	2.80	0.45	13	0.056
12.5	1	3.80	89	5.35	3.15	1.20	1.95	0.32	12	0.039
11.5	1	3.65	192	6.35	3.90	1.25	2.65	0.63	8	0.053

y : quality rating (20 maximum)

x_1 : wine varietal (0—Cabernet Sauvignon, 1—Shiraz)

x_2 : pH

x_3 : Total SO_2 (ppm)

x_4 : color density

x_5 : wine color

x_6 : polymeric pigment color

x_7 : anthocyanin color

x_8 : total anthocyanins (g/L)

x_9 : degree of ionization of anthocyanins (percent)

x_{10} : ionized anthocyanins (percent)

Source: "Wine Quality: Correlations with Colour Density and Anthocyanin Equilibria in a Group of Young Red Wines," by T. C. Somers and M. E. Evans, *Journal of the Science of Food and Agriculture*, **25**, 1369–1379.

TABLE B.20 Methanol Oxidation in Supercritical Water

x_1	x_2	x_3	x_4	x_5	y
0	454	8.8	3.90	1.30	1.1
0	474	8.2	3.68	1.16	4.2
0	524	7.0	2.78	1.25	94.2
0	503	7.4	2.27	1.57	20.7
0	493	7.6	2.40	1.55	15.7
0	493	7.6	1.28	2.71	15.9
0	493	7.5	5.68	0.54	14.7
0	493	7.6	4.65	0.74	10.8
0	493	7.4	3.30	1.01	9.6
0	493	7.4	2.52	1.12	12.7
0	493	7.5	2.44	0.86	7.1
0	493	7.5	2.47	0.45	9.0
1	530	6.7	1.97	1.74	96.0
1	522	6.9	2.03	0.94	78.4
1	522	6.9	2.05	0.93	78.3
1	503	7.3	2.16	0.94	71.4
1	453	8.7	2.76	0.90	0.5
1	483	7.7	2.42	0.91	3.1

x_1 : reactor system

x_2 : temperature (degrees C)

x_3 : reactor residence time (seconds)

x_4 : inlet concentration of methanol

x_5 : ratio of inlet oxygen to inlet methanol

y : percent conversion

Source: "Revised Global Kinetic Measurements of Methanol Oxidation in Supercritical Water," by J. W. Tester, P. A. Webley, and H. R. Holgate, *Industrial and Engineering Chemical Research*, **32**, 236–239.

TABLE B.21 Hald Cement Data

Observation					
i	y_i	x_{i1}	x_{i2}	x_{i3}	x_{i4}
1	78.5	7	26	6	60
2	74.3	1	29	15	52
3	104.3	11	56	8	20
4	87.6	11	31	8	47
5	95.9	7	52	6	33
6	109.2	11	55	9	22
7	102.7	3	71	17	6
8	72.5	1	31	22	44
9	93.1	2	54	18	22
10	115.9	21	47	4	26
11	83.8	1	40	23	34
12	113.3	11	66	9	12
13	109.4	10	68	8	12

Source: Hald, A. [1952], *Statistical Theory with Engineering Applications*, Wiley, New York.

SUPPLEMENTAL TECHNICAL MATERIAL

- C.1 Background on Basic Test Statistics
- C.2 Background from the Theory of linear Models
- C.3 Important Results on SS_R and SS_{Res}
- C.4 Gauss-Markov Theorem, $\text{Var}(\mathbf{e}) = \sigma^2\mathbf{I}$
- C.5 Computational Aspects of Multiple Regression
- C.6 Result on the Inverse of a Matrix
- C.7 Development of the PRESS Statistic
- C.8 Development of $S_{(i)}^2$
- C.9 Outlier Test Based on R -Student
- C.10 Independence of Residuals and Fitted Values
- C.11 Gauss-Markov Theorem, $\text{Var}(\mathbf{e}) = \mathbf{V}$
- C.12 Bias in MS_{Res} When the Model Is Underspecified
- C.13 Computation of Influence Diagnostics
- C.14 Generalized Linear Models

C.1 BACKGROUND ON BASIC TEST STATISTICS

We indicate that Y is a random variable that follows a normal distribution with mean μ and variance σ^2 by

$$Y \sim N(\mu, \sigma^2)$$

C.1.1 Central Distributions

1. Let Y_1, Y_2, \dots, Y_n be independent normally distributed random variables with $E(Y_i) = \mu_i$ and $\text{Var}(Y_i) = \sigma_i^2$. Let a_1, a_2, \dots, a_n be known constants. If we define the linear combination of the Y_i 's by

$$U = \sum_{i=1}^n a_i Y_i$$

then

$$U \sim N\left(\sum_{i=1}^n a_i \mu_i, \sum_{i=1}^n a_i^2 \sigma_i^2\right)$$

The key point is that linear combinations of normally distributed random variables also follow normal distributions.

2. If $Y \sim N(\mu, \sigma^2)$, then

$$Z = \frac{Y - \mu}{\sigma} \sim N(0, 1)$$

Z is called the standard normal random variable.

3. Let $Z = (Y - \mu)/\sigma$. If $Y \sim N(\mu, \sigma^2)$, then Z^2 follows a χ^2 distribution, which we denote by

$$Z^2 \sim \chi_1^2$$

The key point is that the square of a standard normal random variable is a χ^2 random variable with one degree of freedom.

4. Let Y_1, Y_2, \dots, Y_n be independent normally distributed random variables with $E(Y_i) = \mu_i$ and $\text{Var}(Y_i) = \sigma_i^2$, and let

$$Z_i = \frac{Y_i - \mu_i}{\sigma_i}.$$

Then

$$\sum_{i=1}^n Z_i^2 \sim \chi_n^2$$

The key points are (1) the sum of n squared standard normal random variables follows a χ^2 distribution with n degrees of freedom and (2) the sum of χ^2 random variables also follows a χ^2 distribution.

5. **The Central Limit Theorem** If Y_1, Y_2, \dots, Y_n are independent and identically distributed random variables with $E(Y_i) = \mu$ and $\text{Var}(Y_i) = \sigma^2 < \infty$, then

$$\frac{\bar{Y} - \mu}{\sigma/\sqrt{n}}$$

converges in distribution to a standard normal distribution as $n \rightarrow \infty$. The key point is that if n is sufficiently large, then \bar{Y} approximately follows a normal distribution. What constitutes sufficiently large depends on the underlying distribution of the Y_i 's.

6. If $Z \sim N(0, 1)$, $V \sim \chi_v^2$, and Z and V are independent, then

$$\frac{Z}{\sqrt{V/v}} \sim t_v$$

where t_v is the t distribution with v degrees of freedom.

7. Let $V \sim \chi_v^2$, and let $W \sim \chi_\eta^2$. If V and W are independent, then

$$\frac{V/v}{W/\eta} \sim F_{v,\eta}.$$

where $F_{v,\eta}$ is the F distribution with v and η degrees of freedom. The key point is that the ratio of two independent χ^2 random variables, each divided by their respective degrees of freedom, follows an F distribution.

C.1.2 Noncentral Distributions

1. Let $X \sim N(\delta, 1)$, and let $V \sim \chi_v^2$. If X and V are independent, then

$$\frac{X}{\sqrt{V/v}} \sim t'_{v,\delta}$$

where $t'_{v,\delta}$ is the noncentral t distribution with v degrees of freedom and noncentrality parameter δ .

2. If $X \sim N(\delta, 1)$, then

$$X^2 \sim \chi_{1,\delta^2}^{\prime 2}$$

where $\chi_{1,\delta^2}^{\prime 2}$ is the noncentral χ^2 distribution with one degree of freedom and noncentrality parameter δ^2 .

3. If X_1, X_2, \dots, X_n are independent normally distributed random variables with $E(X_i) = \delta_i$ and $\text{Var}(X_i) = 1$, then

$$\sum_{i=1}^n X_i^2 \sim \chi_{n,\lambda}^{\prime 2}$$

where the noncentrality parameter, λ , is

$$\lambda = \sum_{i=1}^n \delta_i^2$$

4. Let $V \sim \chi_{v,\lambda}^2$, and let $W \sim \chi_{\eta}^2$. If V and W are independent, then

$$\frac{V/v}{W/\eta} \sim F'_{v,\eta,\lambda}$$

where $F'_{v,\eta,\lambda}$ is a noncentral F distribution with v and η degrees of freedom and noncentrality parameter λ .

C.2 BACKGROUND FROM THE THEORY OF LINEAR MODELS

C.2.1 Basic Definitions

1. **Rank of a Matrix** The rank of a matrix, \mathbf{A} , is the number of linearly independent columns. Equivalently, it is the number of linearly independent rows.
2. **Identity Matrix** The identity matrix of order k , denoted by \mathbf{I} or \mathbf{I}_k , is a $k \times k$ square matrix whose diagonal elements are 1's and whose nondiagonal elements are 0's; thus,

$$\mathbf{I} = \begin{bmatrix} 1 & 0 & 0 & \cdots & 0 \\ 0 & 1 & 0 & \cdots & 0 \\ \vdots & \vdots & \vdots & \ddots & \vdots \\ 0 & 0 & 0 & \cdots & 1 \end{bmatrix}$$

3. **Inverse of a Matrix** Let \mathbf{A} be a $k \times k$ matrix. The inverse of \mathbf{A} , denoted by \mathbf{A}^{-1} , is another $k \times k$ matrix such that

$$\mathbf{A}\mathbf{A}^{-1} = \mathbf{A}^{-1}\mathbf{A} = \mathbf{I}$$

If the inverse exists, it is unique.

4. **Transpose of a Matrix** Let \mathbf{A} be an $n \times k$ matrix. The transpose of \mathbf{A} , denoted by \mathbf{A}' or \mathbf{A}^T , is a $k \times n$ matrix whose columns are the rows of \mathbf{A} ; thus, if

$$\mathbf{A} = \begin{bmatrix} a_{11} & a_{12} & \cdots & a_{1k} \\ a_{21} & a_{22} & \cdots & a_{2k} \\ \vdots & \vdots & \ddots & \vdots \\ a_{n1} & a_{n2} & \cdots & a_{nk} \end{bmatrix}, \quad \text{then } \mathbf{A}' = \begin{bmatrix} a_{11} & a_{21} & \cdots & a_{n1} \\ a_{12} & a_{22} & \cdots & a_{n2} \\ \vdots & \vdots & \ddots & \vdots \\ a_{1k} & a_{2k} & \cdots & a_{nk} \end{bmatrix}$$

Note: If \mathbf{A} is an $n \times m$ matrix and \mathbf{B} is an $m \times p$ matrix, then

$$(\mathbf{AB})' = \mathbf{B}'\mathbf{A}'$$

5. **Symmetric Matrix** Let \mathbf{A} be a $k \times k$ matrix. \mathbf{A} is said to be symmetric if $\mathbf{A} = \mathbf{A}'$.
6. **Idempotent Matrix** Let \mathbf{A} be a $k \times k$ matrix. \mathbf{A} is called idempotent if

$$\mathbf{A} = \mathbf{AA}$$

If \mathbf{A} is also symmetric, then \mathbf{A} is called symmetric idempotent. If \mathbf{A} is symmetric idempotent, then $\mathbf{I} - \mathbf{A}$ is also symmetric idempotent.

7. **Orthonormal Matrix** Let \mathbf{A} be a $k \times k$ matrix. If \mathbf{A} is an orthonormal matrix, then $\mathbf{A}'\mathbf{A} = \mathbf{I}$. As a consequence, if \mathbf{A} is an orthonormal matrix, then $\mathbf{A}^{-1} = \mathbf{A}'$.
8. **Quadratic Form** Let \mathbf{y} be a $k \times 1$ vector, and let \mathbf{A} be a $k \times k$ matrix. The function

$$\mathbf{y}'\mathbf{A}\mathbf{y} = \sum_{i=1}^k \sum_{j=1}^k a_{ij}y_iy_j$$

is called a quadratic form. \mathbf{A} is called the matrix of the quadratic form.

9. **Positive Definite and Positive Semidefinite Matrices** Let \mathbf{A} be a $k \times k$ matrix. \mathbf{A} is said to be positive definite if the following condition holds

- (a) $\mathbf{A} = \mathbf{A}'$ (\mathbf{A} is symmetric)
 (b) $\mathbf{y}'\mathbf{A}\mathbf{y} > 0 \forall \mathbf{y} \in \mathfrak{R}^k, \mathbf{y} \neq \mathbf{0}$

\mathbf{A} is said to be positive semidefinite if the following condition holds:

- (c) $\mathbf{y}'\mathbf{A}\mathbf{y} = 0$ for some $\mathbf{y} \neq \mathbf{0}$

10. **Trace of a Matrix** Let \mathbf{A} be a $k \times k$ matrix. The trace of \mathbf{A} , denoted by $\text{trace}(\mathbf{A})$ or $\text{tr}(\mathbf{A})$, is the sum of the diagonal elements of \mathbf{A} ; thus,

$$\text{trace}(\mathbf{A}) = \sum_{i=1}^k a_{ii}$$

Note:

- (a) If \mathbf{A} is an $m \times n$ matrix and \mathbf{B} is an $n \times m$ matrix, then

$$\text{trace}(\mathbf{AB}) = \text{trace}(\mathbf{BA})$$

- (b) If the matrices are appropriately conformable, then

$$\text{trace}(\mathbf{ABC}) = \text{trace}(\mathbf{CAB})$$

- (c) If \mathbf{A} and \mathbf{B} are $k \times k$ matrices and a and b are scalars, then

$$\text{trace}(a\mathbf{A} + b\mathbf{B}) = a \text{trace}(\mathbf{A}) + b \text{trace}(\mathbf{B})$$

11. **Rank of an Idempotent Matrix** Let \mathbf{A} be an idempotent matrix. The rank of \mathbf{A} is its trace.
12. **An Important Identity for a Partitioned Matrix** Let \mathbf{X} be an $n \times p$ matrix partitioned such that

$$\mathbf{X} = [\mathbf{X}_1 \mathbf{X}_2]$$

We note that

$$\begin{aligned} \mathbf{X}(\mathbf{X}'\mathbf{X})^{-1}\mathbf{X}'\mathbf{X} &= \mathbf{X} \\ \mathbf{X}(\mathbf{X}'\mathbf{X})^{-1}\mathbf{X}'[\mathbf{X}_1\mathbf{X}_2] &= \mathbf{X} \\ \mathbf{X}(\mathbf{X}'\mathbf{X})^{-1}\mathbf{X}'[\mathbf{X}_1\mathbf{X}_2] &= [\mathbf{X}_1\mathbf{X}_2] \end{aligned}$$

Consequently,

$$\mathbf{X}(\mathbf{X}'\mathbf{X})^{-1}\mathbf{X}'\mathbf{X}_1 = \mathbf{X}_1 \quad \text{and} \quad \mathbf{X}(\mathbf{X}'\mathbf{X})^{-1}\mathbf{X}'\mathbf{X}_2 = \mathbf{X}_2$$

Similarly,

$$\mathbf{X}'_1\mathbf{X}(\mathbf{X}'\mathbf{X})^{-1}\mathbf{X}' = \mathbf{X}'_1 \quad \text{and} \quad \mathbf{X}'_2\mathbf{X}(\mathbf{X}'\mathbf{X})^{-1}\mathbf{X}' = \mathbf{X}'_2$$

13. *Inverse of a Partitioned Matrix* Consider a matrix of the form

$$\mathbf{X}'\mathbf{X} = \begin{bmatrix} \mathbf{X}'_1\mathbf{X}_1 & \mathbf{X}'_1\mathbf{X}_2 \\ \mathbf{X}'_2\mathbf{X}_1 & \mathbf{X}'_2\mathbf{X}_2 \end{bmatrix}$$

It can be shown that the inverse of this matrix is

$$(\mathbf{X}'\mathbf{X})^{-1} = \begin{bmatrix} (\mathbf{X}'_1\mathbf{X}_1)^{-1} + (\mathbf{X}'_1\mathbf{X}_1)^{-1}\mathbf{X}'_1\mathbf{X}_2\mathbf{G}\mathbf{X}'_2\mathbf{X}_1(\mathbf{X}'_1\mathbf{X}_1)^{-1} & -(\mathbf{X}'_1\mathbf{X}_1)^{-1}\mathbf{X}'_1\mathbf{X}_2\mathbf{G} \\ -\mathbf{G}\mathbf{X}'_2\mathbf{X}_1(\mathbf{X}'_1\mathbf{X}_1)^{-1} & \mathbf{G} \end{bmatrix}$$

where $\mathbf{H}_1 = \mathbf{X}_1(\mathbf{X}'_1\mathbf{X}_1)^{-1}\mathbf{X}'_1$ and $\mathbf{G} = [\mathbf{X}'_2(\mathbf{I} - \mathbf{H}_1)\mathbf{X}_2]^{-1}$.

C.2.2 Matrix Derivatives

Let \mathbf{A} be a $k \times k$ matrix of constants, \mathbf{a} be a $k \times 1$ vector of constants, and \mathbf{y} be a $k \times 1$ vector of variables.

1. If $\mathbf{z} = \mathbf{a}'\mathbf{y}$, then

$$\frac{\partial \mathbf{z}}{\partial \mathbf{y}} = \frac{\partial \mathbf{a}'\mathbf{y}}{\partial \mathbf{y}} = \mathbf{a}$$

2. If $\mathbf{z} = \mathbf{y}'\mathbf{y}$, then

$$\frac{\partial \mathbf{z}}{\partial \mathbf{y}} = \frac{\partial \mathbf{y}'\mathbf{y}}{\partial \mathbf{y}} = 2\mathbf{y}$$

3. If $\mathbf{z} = \mathbf{a}'\mathbf{A}\mathbf{y}$, then

$$\frac{\partial \mathbf{z}}{\partial \mathbf{y}} = \frac{\partial \mathbf{a}'\mathbf{A}\mathbf{y}}{\partial \mathbf{y}} = \mathbf{A}'\mathbf{a}$$

4. If $\mathbf{z} = \mathbf{y}'\mathbf{A}\mathbf{y}$, then

$$\frac{\partial \mathbf{z}}{\partial \mathbf{y}} = \frac{\partial \mathbf{y}'\mathbf{A}\mathbf{y}}{\partial \mathbf{y}} = \mathbf{A}\mathbf{y} + \mathbf{A}'\mathbf{y}$$

If \mathbf{A} is symmetric, then

$$\frac{\partial \mathbf{y}'\mathbf{A}\mathbf{y}}{\partial \mathbf{y}} = 2\mathbf{A}\mathbf{y}$$

C.2.3 Expectations

Let \mathbf{A} be a $k \times k$ matrix of constants, \mathbf{a} be a $k \times 1$ vector of constants, and \mathbf{y} be a $k \times 1$ random vector with mean $\boldsymbol{\mu}$ and nonsingular variance–covariance matrix \mathbf{V} .

1. $E(\mathbf{a}'\mathbf{y}) = \mathbf{a}'\boldsymbol{\mu}$.
2. $E(\mathbf{A}\mathbf{y}) = \mathbf{A}\boldsymbol{\mu}$.
3. $\text{Var}(\mathbf{a}'\mathbf{y}) = \mathbf{a}'\mathbf{V}\mathbf{a}$.
4. $\text{Var}(\mathbf{A}\mathbf{y}) = \mathbf{A}\mathbf{V}\mathbf{A}'$.

Note: If $\mathbf{V} = \sigma^2\mathbf{I}$, then $\text{Var}(\mathbf{A}\mathbf{y}) = \sigma^2\mathbf{A}\mathbf{A}'$.

5. $E(\mathbf{y}'\mathbf{A}\mathbf{y}) = \text{trace}(\mathbf{A}\mathbf{V}) + \boldsymbol{\mu}'\mathbf{A}\boldsymbol{\mu}$.

Note: If $\mathbf{V} = \sigma^2\mathbf{I}$, then $E(\mathbf{y}'\mathbf{A}\mathbf{y}) = \sigma^2 \text{trace}(\mathbf{A}) + \boldsymbol{\mu}'\mathbf{A}\boldsymbol{\mu}$.

C.2.4 Distribution Theory

Let \mathbf{A} be a $k \times k$ matrix of constants and \mathbf{y} be a $k \times 1$ multivariate normal random vector with mean $\boldsymbol{\mu}$ and nonsingular variance–covariance matrix \mathbf{V} ; thus,

$$\mathbf{y} \sim N(\boldsymbol{\mu}, \mathbf{V})$$

Let U be the quadratic form defined by $U = \mathbf{y}'\mathbf{A}\mathbf{y}$.

1. If $\mathbf{A}\mathbf{V}$ or $\mathbf{V}\mathbf{A}$ is an idempotent matrix of rank p , then

$$U \sim \chi_{p,\lambda}^2$$

where $\lambda = \boldsymbol{\mu}'\mathbf{A}\boldsymbol{\mu}$.

2. Let $\mathbf{V} = \sigma^2\mathbf{I}$, which is a typical assumption. If \mathbf{A} is idempotent with rank p , then

$$\frac{U}{\sigma^2} \sim \chi_{p,\lambda}^2$$

where $\lambda = \boldsymbol{\mu}'\mathbf{A}\boldsymbol{\mu}/\sigma^2$.

3. Let \mathbf{B} be a $q \times k$ matrix, and let \mathbf{W} be the linear form given by $\mathbf{W} = \mathbf{B}\mathbf{y}$. The quadratic form $U = \mathbf{y}'\mathbf{A}\mathbf{y}$ and \mathbf{W} are independent if

$$\mathbf{BVA} = \mathbf{0}$$

Note: If $\mathbf{V} = \sigma^2\mathbf{I}$, then U and \mathbf{W} are independent if $\mathbf{BA} = \mathbf{0}$.

4. Let \mathbf{B} be a $k \times k$ matrix. Let $V = \mathbf{y}'\mathbf{B}\mathbf{y}$. The two quadratic forms, U and V , are independent if

$$\mathbf{AVB} = \mathbf{0}$$

Note: If $\mathbf{V} = \sigma^2\mathbf{I}$, then U and V are independent if $\mathbf{AB} = \mathbf{0}$.

C.3 IMPORTANT RESULTS ON SS_R AND SS_{RES}

C.3.1 SS_R

By definition,

$$SS_R = \sum_{i=1}^n (\hat{y}_i - \bar{y})^2$$

We note that $\hat{\mathbf{y}} = \mathbf{X}(\mathbf{X}'\mathbf{X})^{-1}\mathbf{X}'\mathbf{y}$ and that

$$\bar{y} = \frac{1}{n} \sum_{i=1}^n y_i = \frac{1}{n} \mathbf{1}'\mathbf{y}$$

where $\mathbf{1}$ is an $n \times 1$ vector all of whose elements are 1's. Further, $n = \mathbf{1}'\mathbf{1}$; thus, $\bar{y} = (\mathbf{1}'\mathbf{1})^{-1}\mathbf{1}'\mathbf{y}$. Consequently, we can write SS_R as

$$\begin{aligned} SS_R &= \sum_{i=1}^n (\hat{y}_i - \bar{y})^2 \\ &= [\hat{\mathbf{y}} - \mathbf{1}\bar{y}]' [\hat{\mathbf{y}} - \mathbf{1}\bar{y}] \\ &= [\mathbf{X}(\mathbf{X}'\mathbf{X})^{-1}\mathbf{X}'\mathbf{y} - \mathbf{1}(\mathbf{1}'\mathbf{1})^{-1}\mathbf{1}'\mathbf{y}]' [\mathbf{X}(\mathbf{X}'\mathbf{X})^{-1}\mathbf{X}'\mathbf{y} - \mathbf{1}(\mathbf{1}'\mathbf{1})^{-1}\mathbf{1}'\mathbf{y}] \\ &= \mathbf{y}' [\mathbf{X}(\mathbf{X}'\mathbf{X})^{-1}\mathbf{X}' - \mathbf{1}(\mathbf{1}'\mathbf{1})^{-1}\mathbf{1}']' [\mathbf{X}(\mathbf{X}'\mathbf{X})^{-1}\mathbf{X}' - \mathbf{1}(\mathbf{1}'\mathbf{1})^{-1}\mathbf{1}'] \mathbf{y} \end{aligned}$$

Please note that $\mathbf{X} = [\mathbf{1} \ \mathbf{X}_R]$, where \mathbf{X}_R is the matrix formed by the actual values for the regressors. Consequently, SS_R involves a special case of a partitioned matrix. We thus may use the special identity for partitioned matrices to show that

$$\mathbf{X}(\mathbf{X}'\mathbf{X})^{-1}\mathbf{X}'\mathbf{1} = \mathbf{1} \quad \text{and} \quad \mathbf{1}'\mathbf{X}(\mathbf{X}'\mathbf{X})^{-1}\mathbf{X}' = \mathbf{1}'$$

Consequently, we can show that $[\mathbf{X}(\mathbf{X}'\mathbf{X})^{-1}\mathbf{X}' - \mathbf{1}(\mathbf{1}'\mathbf{1})^{-1}\mathbf{1}']$ is idempotent. Under the assumption that $\text{Var}(\boldsymbol{\varepsilon}) = \sigma^2\mathbf{I}$,

$$\frac{SS_R}{\sigma^2} = \frac{1}{\sigma^2} \mathbf{y}' [\mathbf{X}(\mathbf{X}'\mathbf{X})^{-1}\mathbf{X}' - \mathbf{1}(\mathbf{1}'\mathbf{1})^{-1}\mathbf{1}'] \mathbf{y}$$

follows a noncentral χ^2 distribution with noncentrality parameter λ and degrees of freedom equal to the rank of $[\mathbf{X}(\mathbf{X}'\mathbf{X})^{-1}\mathbf{X}' - \mathbf{1}(\mathbf{1}'\mathbf{1})^{-1}\mathbf{1}']$. Since this matrix is idempotent, its rank is its trace. We note that

$$\begin{aligned}\text{trace}[\mathbf{X}(\mathbf{X}'\mathbf{X})^{-1}\mathbf{X}' - \mathbf{1}(\mathbf{1}'\mathbf{1})^{-1}\mathbf{1}'] &= \text{trace}[\mathbf{X}(\mathbf{X}'\mathbf{X})^{-1}\mathbf{X}'] - \text{trace}[\mathbf{1}(\mathbf{1}'\mathbf{1})^{-1}\mathbf{1}'] \\ &= \text{trace}[\mathbf{X}'\mathbf{X}(\mathbf{X}'\mathbf{X})^{-1}] - \text{trace}[\mathbf{1}'\mathbf{1}(\mathbf{1}'\mathbf{1})^{-1}] \\ &= \text{trace}(\mathbf{I}_p) - \text{trace}(1) \\ &= p - 1 = k\end{aligned}$$

Under the assumption that the model is correct,

$$E(\mathbf{y}) = \mathbf{X}\boldsymbol{\beta} = [\mathbf{1} \quad \mathbf{X}_R] \begin{bmatrix} \beta_0 \\ \boldsymbol{\beta}_R \end{bmatrix} = \beta_0 \mathbf{1} + \mathbf{X}_R \boldsymbol{\beta}_R$$

Thus, the noncentrality parameter is

$$\begin{aligned}\lambda &= \frac{1}{\sigma^2} E(\mathbf{y})' [\mathbf{X}(\mathbf{X}'\mathbf{X})^{-1}\mathbf{X}' - \mathbf{1}(\mathbf{1}'\mathbf{1})^{-1}\mathbf{1}'] E(\mathbf{y}) \\ &= \frac{1}{\sigma^2} \boldsymbol{\beta}' \mathbf{X}' [\mathbf{X}(\mathbf{X}'\mathbf{X})^{-1}\mathbf{X}' - \mathbf{1}(\mathbf{1}'\mathbf{1})^{-1}\mathbf{1}'] \mathbf{X}\boldsymbol{\beta} \\ &= \frac{1}{\sigma^2} [\beta_0 \quad \boldsymbol{\beta}'_R] \begin{bmatrix} \mathbf{1}' \\ \mathbf{X}'_R \end{bmatrix} [\mathbf{X}(\mathbf{X}'\mathbf{X})^{-1}\mathbf{X}' - \mathbf{1}(\mathbf{1}'\mathbf{1})^{-1}\mathbf{1}'] [\mathbf{1} \quad \mathbf{X}_R] \begin{bmatrix} \beta_0 \\ \boldsymbol{\beta}_R \end{bmatrix} \\ &= \frac{1}{\sigma^2} [\beta_0 \quad \boldsymbol{\beta}'_R] \begin{bmatrix} \mathbf{1}'\mathbf{X}(\mathbf{X}'\mathbf{X})^{-1}\mathbf{X}' - \mathbf{1}'\mathbf{1}(\mathbf{1}'\mathbf{1})^{-1}\mathbf{1}' \\ \mathbf{X}'_R\mathbf{X}(\mathbf{X}'\mathbf{X})^{-1}\mathbf{X}' - \mathbf{X}'_R\mathbf{1}(\mathbf{1}'\mathbf{1})^{-1}\mathbf{1}' \end{bmatrix} [\mathbf{1} \quad \mathbf{X}_R] \begin{bmatrix} \beta_0 \\ \boldsymbol{\beta}_R \end{bmatrix} \\ &= \frac{1}{\sigma^2} [\beta_0 \quad \boldsymbol{\beta}'_R] \begin{bmatrix} \mathbf{0}' \\ \mathbf{X}'_R - \mathbf{X}'_R\mathbf{1}(\mathbf{1}'\mathbf{1})^{-1}\mathbf{1}' \end{bmatrix} [\mathbf{1} \quad \mathbf{X}_R] \begin{bmatrix} \beta_0 \\ \boldsymbol{\beta}_R \end{bmatrix} \\ &= \frac{1}{\sigma^2} [\beta_0 \quad \boldsymbol{\beta}'_R] \begin{bmatrix} 0 & \mathbf{0}' \\ \mathbf{0} & \mathbf{X}'_R\mathbf{X}_R - \mathbf{X}'_R\mathbf{1}(\mathbf{1}'\mathbf{1})^{-1}\mathbf{1}'\mathbf{X}_R \end{bmatrix} \begin{bmatrix} \beta_0 \\ \boldsymbol{\beta}_R \end{bmatrix} \\ &= \frac{1}{\sigma^2} \boldsymbol{\beta}'_R [\mathbf{X}'_R\mathbf{X}_R - \mathbf{X}'_R\mathbf{1}(\mathbf{1}'\mathbf{1})^{-1}\mathbf{1}'\mathbf{X}_R] \boldsymbol{\beta}_R\end{aligned}$$

If we define the matrix of **centered** regressors values, \mathbf{X}_C , by

$$\mathbf{X}_C = \begin{bmatrix} x_{11} - \bar{x}_1 & x_{12} - \bar{x}_2 & \cdots & x_{1k} - \bar{x}_k \\ x_{21} - \bar{x}_1 & x_{22} - \bar{x}_2 & \cdots & x_{2k} - \bar{x}_k \\ \vdots & \vdots & & \vdots \\ x_{n1} - \bar{x}_1 & x_{n2} - \bar{x}_2 & \cdots & x_{nk} - \bar{x}_k \end{bmatrix}$$

where \bar{x}_1 is the average value for the first regressor, \bar{x}_2 is the average value for the second regressor, and so forth, then it is easily established that we can rewrite the noncentrality parameter as

$$\lambda = \frac{1}{\sigma^2} \boldsymbol{\beta}'_R [\mathbf{X}'_C\mathbf{X}_C] \boldsymbol{\beta}_R$$

The expected value for SS_R is

$$\begin{aligned} E(SS_R) &= E(\mathbf{y}'[\mathbf{X}(\mathbf{X}'\mathbf{X})^{-1}\mathbf{X}' - \mathbf{1}(\mathbf{1}'\mathbf{1})^{-1}\mathbf{1}']\mathbf{y}) \\ &= \text{trace}([\mathbf{X}(\mathbf{X}'\mathbf{X})^{-1}\mathbf{X}' - \mathbf{1}(\mathbf{1}'\mathbf{1})^{-1}\mathbf{1}']\sigma^2\mathbf{I}) \\ &\quad + E(\mathbf{y})'[\mathbf{X}(\mathbf{X}'\mathbf{X})^{-1}\mathbf{X}' - \mathbf{1}(\mathbf{1}'\mathbf{1})^{-1}\mathbf{1}']E(\mathbf{y}) \\ &= k\sigma^2 + \boldsymbol{\beta}'_R\mathbf{X}'_C\mathbf{X}_C\boldsymbol{\beta}_R \end{aligned}$$

As a result,

$$E(MS_R) = E\left(\frac{SS_R}{k}\right) = \sigma^2 + \frac{\boldsymbol{\beta}'_R\mathbf{X}'_C\mathbf{X}_C\boldsymbol{\beta}_R}{k}$$

C.3.2 SS_{Res}

By definition,

$$SS_{Res} = \sum_{i=1}^n (y_i - \hat{y}_i)^2$$

We note that we can rewrite SS_{Res} as

$$\begin{aligned} SS_{Res} &= (\mathbf{y} - \hat{\mathbf{y}})'(\mathbf{y} - \hat{\mathbf{y}}) \\ &= [\mathbf{y} - \mathbf{X}(\mathbf{X}'\mathbf{X})^{-1}\mathbf{X}'\mathbf{y}]'[\mathbf{y} - \mathbf{X}(\mathbf{X}'\mathbf{X})^{-1}\mathbf{X}'\mathbf{y}] \\ &= \mathbf{y}'[\mathbf{I} - \mathbf{X}(\mathbf{X}'\mathbf{X})^{-1}\mathbf{X}']\mathbf{y} \end{aligned}$$

It is trivial to show that $[\mathbf{I} - \mathbf{X}(\mathbf{X}'\mathbf{X})^{-1}\mathbf{X}']$ is symmetric idempotent. Consequently,

$$\frac{SS_{Res}}{\sigma^2} = \frac{1}{\sigma^2}\mathbf{y}'[\mathbf{I} - \mathbf{X}(\mathbf{X}'\mathbf{X})^{-1}\mathbf{X}']\mathbf{y}$$

follows a χ^2 distribution. The degrees of freedom come from the rank of $[\mathbf{I} - \mathbf{X}(\mathbf{X}'\mathbf{X})^{-1}\mathbf{X}']$, which is the trace. It is straightforward to show that the trace is $n - p$. Under the assumption that the model is correct,

$$E(\mathbf{y}) = \mathbf{X}\boldsymbol{\beta}$$

Thus, the noncentrality parameter is

$$\begin{aligned} \frac{1}{\sigma^2}E(\mathbf{y})'[\mathbf{I} - \mathbf{X}(\mathbf{X}'\mathbf{X})^{-1}\mathbf{X}']E(\mathbf{y}) &= \frac{1}{\sigma^2}\boldsymbol{\beta}'\mathbf{X}'[\mathbf{I} - \mathbf{X}(\mathbf{X}'\mathbf{X})^{-1}\mathbf{X}']\mathbf{X}\boldsymbol{\beta} \\ &= \frac{1}{\sigma^2}\boldsymbol{\beta}'[\mathbf{X}'\mathbf{X} - \mathbf{X}'\mathbf{X}(\mathbf{X}'\mathbf{X})^{-1}\mathbf{X}'\mathbf{X}]\boldsymbol{\beta} = 0 \end{aligned}$$

As a result,

$$\frac{SS_{\text{Res}}}{\sigma^2} \sim \chi_{n-p}^2$$

The expected value for SS_{Res} is

$$\begin{aligned} E(SS_{\text{Res}}) &= E(\mathbf{y}'[\mathbf{I} - \mathbf{X}(\mathbf{X}'\mathbf{X})^{-1}\mathbf{X}']\mathbf{y}) \\ &= \text{trace}([\mathbf{I} - \mathbf{X}(\mathbf{X}'\mathbf{X})^{-1}\mathbf{X}']\sigma^2\mathbf{I}) + E(\mathbf{y})'[\mathbf{I} - \mathbf{X}(\mathbf{X}'\mathbf{X})^{-1}\mathbf{X}']E(\mathbf{y}) \\ &= (n-p)\sigma^2 \end{aligned}$$

As a result,

$$E(MS_{\text{Res}}) = E\left(\frac{SS_{\text{Res}}}{n-p}\right) = \sigma^2$$

C.3.3 Global or Overall F Test

An F statistic is the ratio of two independent χ^2 random variables, each divided by its respective degrees of freedom. We have shown that both SS_{R}/σ^2 and SS_{Res}/σ^2 follow χ^2 distributions. The key point now is to show that they are independent. From basic linear models theory, SS_{R} and SS_{Res} are independent under the assumption that $\text{Var}(\boldsymbol{\varepsilon}) = \sigma^2\mathbf{I}$ if

$$[\mathbf{X}(\mathbf{X}'\mathbf{X})^{-1}\mathbf{X}' - \mathbf{1}(\mathbf{1}'\mathbf{1})^{-1}\mathbf{1}']\sigma^2\mathbf{I}[\mathbf{I} - \mathbf{X}(\mathbf{X}'\mathbf{X})^{-1}\mathbf{X}'] = \mathbf{0}$$

We note that

$$\begin{aligned} &[\mathbf{X}(\mathbf{X}'\mathbf{X})^{-1}\mathbf{X}' - \mathbf{1}(\mathbf{1}'\mathbf{1})^{-1}\mathbf{1}']\sigma^2\mathbf{I}[\mathbf{I} - \mathbf{X}(\mathbf{X}'\mathbf{X})^{-1}\mathbf{X}'] \\ &= \sigma^2[\mathbf{X}(\mathbf{X}'\mathbf{X})^{-1}\mathbf{X}' - \mathbf{1}(\mathbf{1}'\mathbf{1})^{-1}\mathbf{1}'][\mathbf{I} - \mathbf{X}(\mathbf{X}'\mathbf{X})^{-1}\mathbf{X}'] \\ &= \sigma^2[\mathbf{X}(\mathbf{X}'\mathbf{X})^{-1}\mathbf{X}' - \mathbf{1}(\mathbf{1}'\mathbf{1})^{-1}\mathbf{1}' - \mathbf{X}(\mathbf{X}'\mathbf{X})^{-1}\mathbf{X}'\mathbf{X}(\mathbf{X}'\mathbf{X})^{-1}\mathbf{X}' \\ &\quad + \mathbf{1}(\mathbf{1}'\mathbf{1})^{-1}\mathbf{1}'\mathbf{X}(\mathbf{X}'\mathbf{X})^{-1}\mathbf{X}'] \\ &= \mathbf{X}(\mathbf{X}'\mathbf{X})^{-1}\mathbf{X}' - \mathbf{X}(\mathbf{X}'\mathbf{X})^{-1}\mathbf{X}' - \mathbf{1}(\mathbf{1}'\mathbf{1})^{-1}\mathbf{1}' + \mathbf{1}(\mathbf{1}'\mathbf{1})^{-1}\mathbf{1}' = \mathbf{0} \end{aligned}$$

Thus, SS_{R} and SS_{Res} are independent. We next note that

$$\frac{SS_{\text{R}}}{k\sigma^2} = \frac{MS_{\text{R}}}{\sigma^2} \quad \text{and} \quad \frac{SS_{\text{Res}}}{(n-p)\sigma^2} = \frac{MS_{\text{Res}}}{\sigma^2}$$

are χ^2 random variables, each divided by their respective degrees of freedom. As a result,

$$\frac{MS_{\text{R}}}{MS_{\text{Res}}} \sim F'_{k, n-p, \lambda}$$

where

$$\lambda = \frac{1}{\sigma^2} \boldsymbol{\beta}'_{\text{R}} \mathbf{X}'_{\text{C}} \mathbf{X}_{\text{C}} \boldsymbol{\beta}_{\text{R}}$$

In the special case of simple linear regression, we have only a single regressor; thus, $\beta_R = \beta_1$, and

$$\mathbf{X}'_C \mathbf{X}_C = \sum_{i=1}^n (x_i - \bar{x})^2$$

As a result, for simple linear regression,

$$\frac{MS_R}{MS_{Res}} \sim F_{1, n-2, \lambda}$$

where $\lambda = \beta_1^2 \sum_{i=1}^n (x_i - \bar{x})^2$.

C.3.4 Extra-Sum-of-Squares Principle

SS_R is a special case of the extra-sum-of-squares principle. Consider the model

$$\mathbf{y} = \mathbf{X}\boldsymbol{\beta} + \boldsymbol{\varepsilon} = \mathbf{X}_1\boldsymbol{\beta}_1 + \mathbf{X}_2\boldsymbol{\beta}_2 + \boldsymbol{\varepsilon}$$

where \mathbf{X}_1 is the $p_1 \times 1$ model matrix associated with $\boldsymbol{\beta}_1$, \mathbf{X}_2 is the $p_2 \times 1$ model matrix associated with $\boldsymbol{\beta}_2$, and $p_1 + p_2 = p$. A common measure of the contribution of $\boldsymbol{\beta}_2$ given the presence of $\boldsymbol{\beta}_1$ in the model is

$$R(\boldsymbol{\beta}_2 | \boldsymbol{\beta}_1) = \mathbf{y}' [\mathbf{X}(\mathbf{X}'\mathbf{X})^{-1}\mathbf{X}' - \mathbf{X}_1(\mathbf{X}'_1\mathbf{X}_1)^{-1}\mathbf{X}'_1] \mathbf{y}$$

In the case of SS_R , $\mathbf{X}_1 = \mathbf{1}$ and $\mathbf{X}_2 = \mathbf{X}_R$. In some sense, $SS_R = R(\boldsymbol{\beta}_R | \boldsymbol{\beta}_0)$. It can be shown that $[\mathbf{X}(\mathbf{X}'\mathbf{X})^{-1}\mathbf{X}' - \mathbf{X}_1(\mathbf{X}'_1\mathbf{X}_1)^{-1}\mathbf{X}'_1]$ is symmetric idempotent. The keys to this derivation are that $\mathbf{X}(\mathbf{X}'\mathbf{X})^{-1}\mathbf{X}'\mathbf{X}_1 = \mathbf{X}_1$ and that $\mathbf{X}'_1\mathbf{X}(\mathbf{X}'\mathbf{X})^{-1}\mathbf{X}' = \mathbf{X}'_1$. It is then straightforward to show that

$$\frac{R(\boldsymbol{\beta}_2 | \boldsymbol{\beta}_1)}{\sigma^2} \sim \chi_{p_2, \lambda}^2$$

where $\lambda = (1/\sigma^2) \boldsymbol{\beta}'_2 \mathbf{X}'_2 [\mathbf{I} - \mathbf{X}_1(\mathbf{X}'_1\mathbf{X}_1)^{-1}\mathbf{X}'_1] \mathbf{X}_2 \boldsymbol{\beta}_2$. It then follows that

$$\frac{R(\boldsymbol{\beta}_2 | \boldsymbol{\beta}_1)}{p_2 MS_{Res}} \sim F'_{p_2, n-p, \lambda}$$

C.3.5 Relationship of the t Test for an Individual Coefficient and the Extra-Sum-of-Squares Principle

Squaring the t test for an individual coefficient is exactly equivalent to the F test using the extra-sum-of-squares principle, where \mathbf{X}_2 is simply the column vector of the model matrix \mathbf{X} associated with the specific coefficient, β_j . Once again, consider the model

$$\mathbf{y} = \mathbf{X}\boldsymbol{\beta} + \boldsymbol{\varepsilon} = \mathbf{X}_1\boldsymbol{\beta}_1 + \mathbf{X}_2\boldsymbol{\beta}_2 + \boldsymbol{\varepsilon} \tag{C.3.1}$$

To show that the t test is exactly equivalent to the F test based on the extra-sum-of-squares principle, we need to establish that

$$\frac{\hat{\beta}_j^2}{\text{Var}(\hat{\beta}_j)} = \frac{1}{\sigma^2} \mathbf{y}' [\mathbf{X}(\mathbf{X}'\mathbf{X})^{-1}\mathbf{X}' - \mathbf{X}_1(\mathbf{X}_1'\mathbf{X}_1)^{-1}\mathbf{X}_1'] \mathbf{y}$$

We first need to express $\hat{\beta}_j^2/\text{Var}(\hat{\beta}_j)$ in matrix form. We first note that $\hat{\beta}_j$ and $\text{Var}(\hat{\beta}_j)$ are both scalars. As a result,

$$\frac{\hat{\beta}_j^2}{\text{Var}(\hat{\beta}_j)} = \hat{\beta}_j' [\text{Var}(\hat{\beta}_j)]^{-1} \hat{\beta}_j$$

We now need to express $\hat{\beta}_j$ in matrix form. Let $\mathbf{H}_1 = \mathbf{X}_1(\mathbf{X}_1'\mathbf{X}_1)^{-1}\mathbf{X}_1'$. Premultiplying both sides of (C.3.1) by $\mathbf{I} - \mathbf{H}_1$ yields

$$(\mathbf{I} - \mathbf{H}_1)\mathbf{y} = (\mathbf{I} - \mathbf{H}_1)\mathbf{X}_1\beta_1 + (\mathbf{I} - \mathbf{H}_1)\mathbf{X}_2\beta_2 + (\mathbf{I} - \mathbf{H}_1)\boldsymbol{\varepsilon}$$

However,

$$(\mathbf{I} - \mathbf{H}_1)\mathbf{X}_1 = \mathbf{X}_1 - \mathbf{H}_1\mathbf{X}_1 = \mathbf{X}_1 - \mathbf{X}_1(\mathbf{X}_1'\mathbf{X}_1)^{-1}\mathbf{X}_1'\mathbf{X}_1 = \mathbf{X}_1 - \mathbf{X}_1 = \mathbf{0}$$

Thus,

$$(\mathbf{I} - \mathbf{H}_1)\mathbf{y} = (\mathbf{I} - \mathbf{H}_1)\mathbf{X}_2\beta_2 + (\mathbf{I} - \mathbf{H}_1)\boldsymbol{\varepsilon}$$

Let $\mathbf{y}^* = (\mathbf{I} - \mathbf{H}_1)\mathbf{y}$, $\mathbf{X}_2^* = (\mathbf{I} - \mathbf{H}_1)\mathbf{X}_2$, and $\boldsymbol{\varepsilon}^* = (\mathbf{I} - \mathbf{H}_1)\boldsymbol{\varepsilon}$. We observe that

$$\text{Var}(\boldsymbol{\varepsilon}^*) = \text{Var}[(\mathbf{I} - \mathbf{H}_1)\boldsymbol{\varepsilon}] = \sigma^2[\mathbf{I} - \mathbf{H}_1]$$

For this particular case, the ordinary least-squares estimate of β_2 is the same as the generalized least squares estimate. We leave the proof to the reader. The appropriate estimate of β_2 is

$$\begin{aligned} \hat{\beta}_2 &= (\mathbf{X}_2^{*'}\mathbf{X}_2^*)^{-1}\mathbf{X}_2^{*'}\mathbf{y}^* \\ &= [\mathbf{X}_2'(\mathbf{I} - \mathbf{H}_1)'(\mathbf{I} - \mathbf{H}_1)\mathbf{X}_2]^{-1}\mathbf{X}_2'(\mathbf{I} - \mathbf{H}_1)'(\mathbf{I} - \mathbf{H}_1)\mathbf{y} \end{aligned}$$

However, $\mathbf{I} - \mathbf{H}_1$ is symmetric and idempotent. As a result,

$$\hat{\beta}_2 = [\mathbf{X}_2'(\mathbf{I} - \mathbf{H}_1)\mathbf{X}_2]^{-1}\mathbf{X}_2'(\mathbf{I} - \mathbf{H}_1)\mathbf{y}$$

It can be shown that

$$\text{Var}(\hat{\beta}_2) = \sigma^2[\mathbf{X}_2'(\mathbf{I} - \mathbf{H}_1)\mathbf{X}_2]^{-1}$$

As a result,

$$\frac{\hat{\beta}_j^2}{\text{Var}(\hat{\beta}_j)} = \hat{\beta}_2' [\text{Var}(\hat{\beta}_2)]^{-1} \hat{\beta}_2 = \frac{1}{\sigma^2} \mathbf{y}' (\mathbf{I} - \mathbf{H}_1)\mathbf{X}_2 [\mathbf{X}_2'(\mathbf{I} - \mathbf{H}_1)\mathbf{X}_2]^{-1} \mathbf{X}_2'(\mathbf{I} - \mathbf{H}_1)\mathbf{y} \quad (\text{C.3.2})$$

Recall from Section C.2.1 (13),

$$(\mathbf{X}'\mathbf{X})^{-1} = \begin{bmatrix} (\mathbf{X}'_1\mathbf{X}_1)^{-1} + (\mathbf{X}'_1\mathbf{X}_1)^{-1}\mathbf{X}'_1\mathbf{X}_2\mathbf{G}\mathbf{X}'_2\mathbf{X}_1(\mathbf{X}'_1\mathbf{X}_1)^{-1} & -(\mathbf{X}'_1\mathbf{X}_1)^{-1}\mathbf{X}'_1\mathbf{X}_2\mathbf{G} \\ -\mathbf{G}\mathbf{X}'_2\mathbf{X}_1(\mathbf{X}'_1\mathbf{X}_1)^{-1} & \mathbf{G} \end{bmatrix}$$

where $\mathbf{H}_1 = \mathbf{X}_1(\mathbf{X}'_1\mathbf{X}_1)^{-1}\mathbf{X}'_1$ and $\mathbf{G} = [\mathbf{X}'_2(\mathbf{I} - \mathbf{H}_1)\mathbf{X}_2]^{-1}$. As a result,

$$\begin{aligned} \mathbf{X}(\mathbf{X}'\mathbf{X})^{-1}\mathbf{X}' &= [\mathbf{X}_1\mathbf{X}_2] \begin{bmatrix} (\mathbf{X}'_1\mathbf{X}_1)^{-1} + (\mathbf{X}'_1\mathbf{X}_1)^{-1}\mathbf{X}'_1\mathbf{X}_2\mathbf{G}\mathbf{X}'_2\mathbf{X}_1(\mathbf{X}'_1\mathbf{X}_1)^{-1} \\ -\mathbf{G}\mathbf{X}'_2\mathbf{X}_1(\mathbf{X}'_1\mathbf{X}_1)^{-1} \\ -(\mathbf{X}'_1\mathbf{X}_1)^{-1}\mathbf{X}'_1\mathbf{X}_2\mathbf{G} \end{bmatrix} \begin{bmatrix} \mathbf{X}'_1 \\ \mathbf{X}'_2 \end{bmatrix} \\ &= \mathbf{H}_1 + \mathbf{H}_1\mathbf{X}_2\mathbf{G}\mathbf{X}'_2\mathbf{H}_1 - \mathbf{X}_2\mathbf{G}\mathbf{X}'_2\mathbf{H}_1 - \mathbf{H}_1\mathbf{X}_2\mathbf{G}\mathbf{X}'_2 + \mathbf{X}_2\mathbf{G}\mathbf{X}'_2 \\ &= \mathbf{H}_1 - (\mathbf{I} - \mathbf{H}_1)\mathbf{X}_2\mathbf{G}\mathbf{X}'_2(\mathbf{I} - \mathbf{H}_1) \end{aligned}$$

As a result,

$$\mathbf{X}(\mathbf{X}'\mathbf{X})^{-1}\mathbf{X}' - \mathbf{X}_1(\mathbf{X}'_1\mathbf{X}_1)^{-1}\mathbf{X}'_1 = (\mathbf{I} - \mathbf{H}_1)\mathbf{X}_2\mathbf{G}\mathbf{X}'_2(\mathbf{I} - \mathbf{H}_1)$$

Consequently,

$$\begin{aligned} \frac{1}{\sigma^2}\mathbf{y}'[\mathbf{X}(\mathbf{X}'\mathbf{X})^{-1}\mathbf{X}' - \mathbf{X}_1(\mathbf{X}'_1\mathbf{X}_1)^{-1}\mathbf{X}'_1]\mathbf{y} &= \frac{1}{\sigma^2}\mathbf{y}'(\mathbf{I} - \mathbf{H}_1)\mathbf{X}_2\mathbf{G}\mathbf{X}'_2(\mathbf{I} - \mathbf{H}_1)\mathbf{y} \\ &= \frac{1}{\sigma^2}\mathbf{y}(\mathbf{I} - \mathbf{H}_1)\mathbf{X}_2[\mathbf{X}'_2(\mathbf{I} - \mathbf{H}_1)\mathbf{X}_2]^{-1}(\mathbf{I} - \mathbf{H}_1)\mathbf{y} \end{aligned}$$

which is exactly (C.3.2). Thus, the square of the t test for an individual coefficient is exactly the same F statistic based on the extra-sum-of-squares principle.

C.4 GAUSS-MARKOV THEOREM, $\text{VAR}(\varepsilon) = \sigma^2 \mathbf{I}$

The Gauss-Markov Theorem establishes that the ordinary least-squares (OLS) estimator of $\boldsymbol{\beta}$, $\hat{\boldsymbol{\beta}} = (\mathbf{X}'\mathbf{X})^{-1}\mathbf{X}'\mathbf{y}$, is BLUE (**best linear unbiased estimator**). By best, we mean that $\hat{\boldsymbol{\beta}}$ has the smallest variance, in some meaningful sense, among the class of all unbiased estimators that are linear combinations of the data. One problem is that $\hat{\boldsymbol{\beta}}$ is a vector; hence, its variance is actually a matrix. Consequently, we seek to show that $\hat{\boldsymbol{\beta}}$ minimizes the variance for any linear combination of the estimated coefficients, $\ell'\hat{\boldsymbol{\beta}}$. We note that

$$\begin{aligned} \text{Var}(\ell'\hat{\boldsymbol{\beta}}) &= \ell'\text{Var}(\hat{\boldsymbol{\beta}})\ell \\ &= \ell'[\sigma^2(\mathbf{X}'\mathbf{X})^{-1}]\ell \\ &= \sigma^2\ell'(\mathbf{X}'\mathbf{X})^{-1}\ell \end{aligned}$$

which is a scalar. Let $\tilde{\boldsymbol{\beta}}$ be another unbiased estimator of $\boldsymbol{\beta}$ that is a linear combination of the data. Our goal, then, is to show that $\text{Var}(\ell'\tilde{\boldsymbol{\beta}}) \geq \sigma^2\ell'(\mathbf{X}'\mathbf{X})^{-1}\ell$ with at least one ℓ such that $\text{Var}(\ell'\tilde{\boldsymbol{\beta}}) > \sigma^2\ell'(\mathbf{X}'\mathbf{X})^{-1}\ell$.

We first note that we can write any other estimator of β that is a linear combination of the data as

$$\tilde{\beta} = [(\mathbf{X}'\mathbf{X})^{-1}\mathbf{X}' + \mathbf{B}]\mathbf{y} + \mathbf{b}_0$$

where \mathbf{B} is a $p \times n$ matrix and \mathbf{b}_0 is a $p \times 1$ vector of constants that appropriately adjusts the OLS estimator to form the alternative estimate. We next note that if the model is correct, then

$$\begin{aligned} E(\tilde{\beta}) &= E([(\mathbf{X}'\mathbf{X})^{-1}\mathbf{X}' + \mathbf{B}]\mathbf{y} + \mathbf{b}_0) \\ &= [(\mathbf{X}'\mathbf{X})^{-1}\mathbf{X}' + \mathbf{B}](\mathbf{y}) + \mathbf{b}_0 \\ &= [(\mathbf{X}'\mathbf{X})^{-1}\mathbf{X}' + \mathbf{B}]\mathbf{X}\beta + \mathbf{b}_0 \\ &= (\mathbf{X}'\mathbf{X})^{-1}\mathbf{X}'\mathbf{X}\beta + \mathbf{B}\mathbf{X}\beta + \mathbf{b}_0 \\ &= \beta + \mathbf{B}\mathbf{X}\beta + \mathbf{b}_0 \end{aligned}$$

Consequently, $\tilde{\beta}$ is unbiased if and only if both $\mathbf{b}_0 = \mathbf{0}$ and $\mathbf{B}\mathbf{X} = \mathbf{0}$. The variance of $\tilde{\beta}$ is

$$\begin{aligned} \text{Var}(\tilde{\beta}) &= \text{Var}([(\mathbf{X}'\mathbf{X})^{-1}\mathbf{X}' + \mathbf{B}]\mathbf{y}) \\ &= [(\mathbf{X}'\mathbf{X})^{-1}\mathbf{X}' + \mathbf{B}]\text{Var}(\mathbf{y})[(\mathbf{X}'\mathbf{X})^{-1}\mathbf{X}' + \mathbf{B}]' \\ &= [(\mathbf{X}'\mathbf{X})^{-1}\mathbf{X}' + \mathbf{B}]\sigma^2\mathbf{I}[(\mathbf{X}'\mathbf{X})^{-1}\mathbf{X}' + \mathbf{B}]' \\ &= \sigma^2[(\mathbf{X}'\mathbf{X})^{-1}\mathbf{X}' + \mathbf{B}][\mathbf{X}(\mathbf{X}'\mathbf{X})^{-1} + \mathbf{B}'] \\ &= \sigma^2[(\mathbf{X}'\mathbf{X})^{-1}\mathbf{X}' + \mathbf{B}\mathbf{B}'] \end{aligned}$$

because $\mathbf{B}\mathbf{X} = \mathbf{0}$, which in turn implies that $(\mathbf{B}\mathbf{X})' = \mathbf{X}'\mathbf{B}' = \mathbf{0}$. As a result,

$$\begin{aligned} \text{Var}(\ell'\tilde{\beta}) &= \ell'\text{Var}(\tilde{\beta})\ell \\ &= \ell'(\sigma^2[(\mathbf{X}'\mathbf{X})^{-1}\mathbf{X}' + \mathbf{B}\mathbf{B}'])\ell \\ &= \sigma^2\ell'(\mathbf{X}'\mathbf{X})^{-1}\ell + \sigma^2\ell'\mathbf{B}\mathbf{B}'\ell \\ &= \text{Var}(\ell'\tilde{\beta}) + \sigma^2\ell'\mathbf{B}\mathbf{B}'\ell \end{aligned}$$

We first note that $\mathbf{B}\mathbf{B}'$ is at least a positive semidefinite matrix; hence, $\sigma^2\ell'\mathbf{B}\mathbf{B}'\ell \geq 0$. Next note that we can define $\ell^* = \mathbf{B}'\ell$. As a result,

$$\ell'\mathbf{B}\mathbf{B}'\ell = \ell^{*'}\ell^* = \sum_{i=1}^p \ell_i^{*2}$$

which must be strictly greater than 0 for some $\ell \neq \mathbf{0}$ unless $\mathbf{B} = \mathbf{0}$. Thus, the OLS estimate of β is the best linear unbiased estimator.

C.5 COMPUTATIONAL ASPECTS OF MULTIPLE REGRESSION

In this section we briefly outline an important computational procedure for solving the least-squares regression problem. The least-squares criterion is

$$\min_{\beta} S(\beta) = (\mathbf{y} - \mathbf{X}\beta)'(\mathbf{y} - \mathbf{X}\beta)$$

and recall from Section 3.2.2 that the least-squares solution vector is normal to the p -dimensional estimation space. Since the Euclidean norm is invariant under an orthogonal transformation, an equivalent formulation of the least-squares problem is

$$\min_{\beta} S(\beta) = (\mathbf{Q}\mathbf{y} - \mathbf{Q}\mathbf{X}\beta)'(\mathbf{Q}\mathbf{y} - \mathbf{Q}\mathbf{X}\beta) \tag{C.5.1}$$

where \mathbf{Q} is an $n \times n$ orthogonal matrix. Now \mathbf{Q} may be chosen so that

$$\mathbf{Q}\mathbf{X} = \begin{bmatrix} \mathbf{R} \\ \mathbf{0} \end{bmatrix}$$

where \mathbf{R} is a $p \times p$ upper triangular matrix (i.e., a matrix with zeros below the main diagonal). If we let

$$\mathbf{Q}\mathbf{y} = \begin{bmatrix} \mathbf{q}_1 \\ \mathbf{q}_2 \end{bmatrix} = \begin{bmatrix} \mathbf{Q}'_1\mathbf{y} \\ \mathbf{Q}'_2\mathbf{y} \end{bmatrix}$$

where \mathbf{Q}'_1 is a $p \times n$ matrix consisting of the first p rows of \mathbf{Q} , \mathbf{Q}'_2 is an $(n - p) \times n$ matrix consisting of the last $n - p$ rows of \mathbf{Q} , and \mathbf{q}_1 is a $p \times 1$ column vector, then the solution to (C.5.1) satisfies

$$\mathbf{R}\hat{\beta} = \mathbf{q}_1 \tag{C.5.2}$$

or

$$\hat{\beta} = \mathbf{R}^{-1}\mathbf{q}_1 = \mathbf{R}^{-1}\mathbf{Q}'_1\mathbf{y} \tag{C.5.3}$$

One advantage of this approach is that we can obtain a numerically stable inverse of \mathbf{R} by the method of back substitution. To illustrate, suppose that \mathbf{R} and $\mathbf{q}_1 = \mathbf{Q}'_1\mathbf{y}$ are, for $p = 3$,

$$\mathbf{R} = \begin{bmatrix} 3 & 1 & 2 \\ 0 & 3 & 1 \\ 0 & 0 & 2 \end{bmatrix}, \quad \mathbf{q}_1 = \mathbf{Q}'_1\mathbf{y} = \begin{bmatrix} 3 \\ -1 \\ 4 \end{bmatrix}$$

The equations (C.5.2) are

$$\begin{bmatrix} 3 & 1 & 2 \\ 0 & 3 & 1 \\ 0 & 0 & 2 \end{bmatrix} \begin{bmatrix} \hat{\beta}_0 \\ \hat{\beta}_1 \\ \hat{\beta}_2 \end{bmatrix} = \begin{bmatrix} 3 \\ -1 \\ 4 \end{bmatrix}$$

and the system of equations that must actually be solved is

$$\begin{aligned} 3\hat{\beta}_0 + 1\hat{\beta}_1 + 2\hat{\beta}_2 &= 3 \\ 3\hat{\beta}_1 + 1\hat{\beta}_2 &= -1 \\ 2\hat{\beta}_2 &= 4 \end{aligned}$$

From the bottom equation, we have $2\hat{\beta}_2 = 4$ or $\hat{\beta}_2 = 2$. Substituting in the equation directly, it yields $3\hat{\beta}_1 + 1(2) = -1$ or $\hat{\beta}_1 = -1$. Finally, the first equation gives $3\hat{\beta}_0 + 1\hat{\beta}_1 + 2\hat{\beta}_2 = 3$ or $\hat{\beta}_0 = 0$.

Algorithms for computing the **QR** decomposition are described by Golub [1969], Lawson and Hanson [1974], and Seber [1977].

The $(\mathbf{X}'\mathbf{X})^{-1}$ matrix can be found directly from the **QR** factorization. Since

$$\mathbf{QX} = \begin{bmatrix} \mathbf{R} \\ \mathbf{0} \end{bmatrix}$$

then

$$\mathbf{X} = \mathbf{Q}' \begin{bmatrix} \mathbf{R} \\ \mathbf{0} \end{bmatrix} = \mathbf{Q}_1 \mathbf{R}$$

Consequently, since $\mathbf{Q}_1' \mathbf{Q}_1 = \mathbf{I}$,

$$(\mathbf{X}'\mathbf{X})^{-1} = (\mathbf{R}'\mathbf{Q}_1'\mathbf{Q}_1\mathbf{R})^{-1} = (\mathbf{R}'\mathbf{R})^{-1} = \mathbf{R}^{-1}(\mathbf{R}')^{-1} \quad (\text{C.5.4})$$

This decomposition also leads to efficient computation of the elements of the hat matrix, which we have seen to be useful in several respects. Note that

$$\mathbf{H} = \mathbf{X}(\mathbf{X}'\mathbf{X})^{-1}\mathbf{X}' = \mathbf{Q}_1\mathbf{R}\mathbf{R}^{-1}(\mathbf{R}')^{-1}\mathbf{R}'\mathbf{Q}_1' = \mathbf{Q}_1\mathbf{Q}_1' \quad (\text{C.5.5})$$

Therefore, the main diagonal elements of the hat matrix may be formed as the sums of squares of the rows of \mathbf{Q}_1 . Thus, we may easily compute many important regression diagnostic statistics, such as the studentized residuals and Cook's distance measure. Belsley, Kuh, and Welsch [1980] show how a number of regression diagnostics may be computed using these ideas.

C.6 RESULT ON THE INVERSE OF A MATRIX

The result given in this section is the Sherman–Morrison–Woodbury theorem (or the Woodbury matrix identity). It is used in obtaining the computational form of the PRESS statistic and several influence diagnostics. Consider the $p \times p$ matrix $\mathbf{X}'\mathbf{X}$ and let \mathbf{x}' be the i th row of \mathbf{X} . Note that $\mathbf{X}'\mathbf{X} - \mathbf{xx}'$ is the $\mathbf{X}'\mathbf{X}$ matrix with the i th row removed. The result is

$$(\mathbf{X}'\mathbf{X} - \mathbf{xx}')^{-1} = (\mathbf{X}'\mathbf{X})^{-1} + \frac{(\mathbf{X}'\mathbf{X})^{-1}\mathbf{xx}'(\mathbf{X}'\mathbf{X})^{-1}}{1 - \mathbf{x}'(\mathbf{X}'\mathbf{X})^{-1}\mathbf{x}} \quad (\text{C.6.1})$$

This result can be proved by multiplying the right-hand side by $\mathbf{X}'\mathbf{X} - \mathbf{xx}'$ to give an identity matrix as follows:

$$\begin{aligned}
 & \left[(\mathbf{X}'\mathbf{X})^{-1} + \frac{(\mathbf{X}'\mathbf{X})^{-1}\mathbf{xx}'(\mathbf{X}'\mathbf{X})^{-1}}{1 - \mathbf{x}'(\mathbf{X}'\mathbf{X})^{-1}\mathbf{x}} \right] (\mathbf{X}'\mathbf{X} - \mathbf{xx}') \\
 &= \mathbf{I} + \frac{(\mathbf{X}'\mathbf{X})^{-1}\mathbf{xx}'}{1 - \mathbf{x}'(\mathbf{X}'\mathbf{X})^{-1}\mathbf{x}} - (\mathbf{X}'\mathbf{X})^{-1}\mathbf{xx}' - \frac{(\mathbf{X}'\mathbf{X})^{-1}\mathbf{xx}'}{1 - \mathbf{x}'(\mathbf{X}'\mathbf{X})^{-1}\mathbf{x}} (\mathbf{X}'\mathbf{X})^{-1}\mathbf{xx}' \\
 &= \mathbf{I} + \frac{(\mathbf{X}'\mathbf{X})^{-1}\mathbf{xx}' - (\mathbf{X}'\mathbf{X})^{-1}\mathbf{xx}'(1 - \mathbf{x}'(\mathbf{X}'\mathbf{X})^{-1}\mathbf{x}) - (\mathbf{X}'\mathbf{X})^{-1}\mathbf{x}[\mathbf{x}'(\mathbf{X}'\mathbf{X})^{-1}\mathbf{x}]\mathbf{x}'}{1 - \mathbf{x}'(\mathbf{X}'\mathbf{X})^{-1}\mathbf{x}} \\
 &= \mathbf{I} - \frac{(\mathbf{X}'\mathbf{X})^{-1}\mathbf{xx}' - (\mathbf{X}'\mathbf{X})^{-1}\mathbf{xx}' + (\mathbf{X}'\mathbf{X})^{-1}\mathbf{xx}'[\mathbf{x}'(\mathbf{X}'\mathbf{X})^{-1}\mathbf{x}] - (\mathbf{X}'\mathbf{X})^{-1}\mathbf{xx}'[\mathbf{x}'(\mathbf{X}'\mathbf{X})^{-1}\mathbf{x}]}{1 - \mathbf{x}'(\mathbf{X}'\mathbf{X})^{-1}\mathbf{x}} \\
 &= \mathbf{I}
 \end{aligned}$$

Note that we can write the result (C.6.1) as

$$[\mathbf{X}'_{(i)}\mathbf{X}_{(i)}]^{-1} = (\mathbf{X}'\mathbf{X})^{-1} + \frac{(\mathbf{X}'\mathbf{X})^{-1}\mathbf{x}_i\mathbf{x}'_i(\mathbf{X}'\mathbf{X})^{-1}}{1 - h_{ii}} \quad (\text{C.6.2})$$

since $h_{ii} = \mathbf{x}'_i(\mathbf{X}'\mathbf{X})^{-1}\mathbf{x}_i$ and $\mathbf{X}_{(i)}$ represents the original \mathbf{X} matrix with the i th row \mathbf{x}_i withheld.

C.7 DEVELOPMENT OF THE PRESS STATISTIC

We have used the PRESS statistic as a measure of regression model validity and potential performance in prediction. Recall that $e_{(i)} = y_i - \hat{y}_{(i)}$ is the PRESS residual, where $\hat{y}_{(i)}$ is the predicted value obtained from a model fit with the i th observation withheld. Then

$$\text{PRESS} = \sum_{i=1}^n e_{(i)}^2 = \sum_{i=1}^n [y_i - \hat{y}_{(i)}]^2 \quad (\text{C.7.1})$$

It would initially seem that calculating PRESS requires fitting n different regressions. However, it is possible to calculate PRESS from the results of a single least-squares fit to all n observations. To see how this is accomplished, let $\hat{\boldsymbol{\beta}}_{(i)}$ be the vector of regression coefficients obtained by withholding the i th observation. Then

$$\hat{\boldsymbol{\beta}}_{(i)} = [\mathbf{X}'_{(i)}\mathbf{X}_{(i)}]^{-1}\mathbf{X}'_{(i)}\mathbf{y}_{(i)} \quad (\text{C.7.2})$$

where $\mathbf{X}_{(i)}$ and $\mathbf{y}_{(i)}$ are the \mathbf{X} and \mathbf{y} vectors with the i th observation withheld.

Thus, the i th PRESS residual may be written as

$$\begin{aligned}
 e_{(i)} &= y_i - \hat{y}_{(i)} \\
 &= y_i - \mathbf{x}'_i\hat{\boldsymbol{\beta}}_{(i)} \\
 &= y_i - \mathbf{x}'_i(\mathbf{X}'_{(i)}\mathbf{X}_{(i)})^{-1}\mathbf{X}'_{(i)}\mathbf{y}_{(i)}
 \end{aligned}$$

There is a close connection between the $(\mathbf{X}'\mathbf{X})^{-1}$ and $[\mathbf{X}_{(i)}\mathbf{X}_{(i)}]^{-1}$ matrices; specifically, from Eq. (C.6.2),

$$[\mathbf{X}'_{(i)}\mathbf{X}_{(i)}]^{-1} = (\mathbf{X}'\mathbf{X})^{-1} + \frac{(\mathbf{X}'\mathbf{X})^{-1}\mathbf{x}_i\mathbf{x}'_i(\mathbf{X}'\mathbf{X})^{-1}}{1-h_{ii}} \quad (\text{C.7.3})$$

where $h_{ii} = \mathbf{x}'_i(\mathbf{X}'\mathbf{X})^{-1}\mathbf{x}_i$. Using Eq. (C.7.3), we may write

$$\begin{aligned} e_{(i)} &= y_i - \mathbf{x}'_i \left[(\mathbf{X}'\mathbf{X})^{-1} + \frac{(\mathbf{X}'\mathbf{X})^{-1}\mathbf{x}_i\mathbf{x}'_i(\mathbf{X}'\mathbf{X})^{-1}}{1-h_{ii}} \right] \mathbf{X}'_{(i)}\mathbf{y}_{(i)} \\ &= y_i - \mathbf{x}'_i(\mathbf{X}'\mathbf{X})^{-1}\mathbf{X}'_{(i)}\mathbf{y}_{(i)} - \frac{\mathbf{x}'_i(\mathbf{X}'\mathbf{X})^{-1}\mathbf{x}_i\mathbf{x}'_i(\mathbf{X}'\mathbf{X})^{-1}\mathbf{X}'_{(i)}\mathbf{y}_{(i)}}{1-h_{ii}} \\ &= \frac{(1-h_{ii})y_i - (1-h_{ii})\mathbf{x}'_i(\mathbf{X}'\mathbf{X})^{-1}\mathbf{X}'_{(i)}\mathbf{y}_{(i)} - h_{ii}\mathbf{x}'_i(\mathbf{X}'\mathbf{X})^{-1}\mathbf{X}'_{(i)}\mathbf{y}_{(i)}}{1-h_{ii}} \\ &= \frac{(1-h_{ii})y_i - \mathbf{x}'_i(\mathbf{X}'\mathbf{X})^{-1}\mathbf{X}'_{(i)}\mathbf{y}_{(i)}}{1-h_{ii}} \end{aligned}$$

Since $\mathbf{X}'\mathbf{y} = \mathbf{X}'_{(i)}\mathbf{y}_{(i)} + \mathbf{x}_i y_i$, this last equation becomes

$$\begin{aligned} e_{(i)} &= \frac{(1-h_{ii})y_i - \mathbf{x}'_i(\mathbf{X}'\mathbf{X})^{-1}(\mathbf{X}'\mathbf{y} - \mathbf{x}_i y_i)}{1-h_{ii}} \\ &= \frac{(1-h_{ii})y_i - \mathbf{x}'_i(\mathbf{X}'\mathbf{X})^{-1}\mathbf{X}'\mathbf{y} + \mathbf{x}'_i(\mathbf{X}'\mathbf{X})^{-1}\mathbf{x}_i y_i}{1-h_{ii}} \\ &= \frac{(1-h_{ii})y_i - \mathbf{x}'_i\hat{\boldsymbol{\beta}} + h_{ii}y_i}{1-h_{ii}} \\ &= \frac{y_i - \mathbf{x}'_i\hat{\boldsymbol{\beta}}}{1-h_{ii}} \end{aligned} \quad (\text{C.7.4})$$

Now the numerator of Eq. (C.7.4) is the ordinary residual e_i from a least-squares fit to all n observations, so the i th PRESS residual is

$$e_{(i)} = \frac{e_i}{1-h_{ii}} \quad (\text{C.7.5})$$

Thus, since PRESS is just the sum of the squares of the PRESS residuals, a simple computing formula is

$$\text{PRESS} = \sum_{i=1}^n \left(\frac{e_i}{1-h_{ii}} \right)^2 \quad (\text{C.7.6})$$

In this form, it is easy to see that PRESS is just a weighted sum of squares of the residuals, where the weights are related to the leverage of the observations. PRESS weights the residuals corresponding to high-leverage observations more severely than the residuals from less influential points.

C.8 DEVELOPMENT OF $S_{(i)}^2$

In Chapter 4 we presented an expression for the residual mean square in a regression model with the i th observation withheld. The resulting quantity, $S_{(i)}^2$, is used in computing R -student. This computing formula for $S_{(i)}^2$ may be derived by starting with the Sherman–Morrison–Woodbury identity from Section C.6:

$$[\mathbf{X}'_{(i)}\mathbf{X}_{(i)}]^{-1} = (\mathbf{X}'\mathbf{X})^{-1} + \frac{(\mathbf{X}'\mathbf{X})^{-1}\mathbf{x}_i\mathbf{x}'_i(\mathbf{X}'\mathbf{X})^{-1}}{1-h_{ii}}$$

If we postmultiply both sides by $\mathbf{X}'\mathbf{y} - \mathbf{x}_i y_i$, we obtain

$$\hat{\boldsymbol{\beta}}_{(i)} = \hat{\boldsymbol{\beta}} - (\mathbf{X}'\mathbf{X})^{-1}\mathbf{x}_i y_i + \frac{(\mathbf{X}'\mathbf{X})^{-1}\mathbf{x}_i\mathbf{x}'_i(\mathbf{X}'\mathbf{X})^{-1}(\mathbf{X}'\mathbf{y} - \mathbf{x}_i y_i)}{1-h_{ii}}$$

which reduces to

$$\hat{\boldsymbol{\beta}} - \hat{\boldsymbol{\beta}}_{(i)} = \frac{(\mathbf{X}'\mathbf{X})^{-1}\mathbf{x}_i e_i}{1-h_{ii}} \quad (\text{C.8.1})$$

Now

$$(n-p-1)S_{(i)}^2 = \sum_{j \neq i} (y_j - \mathbf{x}'_j \hat{\boldsymbol{\beta}}_{(i)})^2 \quad (\text{C.8.2})$$

and after using Eq. (C.8.1), this becomes

$$\begin{aligned} \sum_{j \neq i} (y_j - \mathbf{x}'_j \hat{\boldsymbol{\beta}}_{(i)})^2 &= \sum_{j=1}^n \left(y_j - \mathbf{x}'_j \hat{\boldsymbol{\beta}} + \frac{\mathbf{x}'_j (\mathbf{X}'\mathbf{X})^{-1} \mathbf{x}_i e_i}{1-h_{ii}} \right)^2 - \left(y_i - \mathbf{x}'_i \hat{\boldsymbol{\beta}} + \frac{h_{ii} e_i}{1-h_{ii}} \right)^2 \\ &= \sum_{j=1}^n \left(e_j + \frac{h_{ij} e_i}{1-h_{ii}} \right)^2 - \frac{e_i^2}{(1-h_{ii})^2} \end{aligned} \quad (\text{C.8.3})$$

When we expand the first term on the right-hand side of Eq. (C.8.3), we obtain

$$\sum_{j=1}^n \left(e_j + \frac{h_{ij} e_i}{1-h_{ii}} \right)^2 = \sum_{j=1}^n e_j^2 + \frac{2e_i}{1-h_{ii}} \sum_{j=1}^n e_j h_{ij} - \frac{e_i^2}{(1-h_{ii})^2} \sum_{j=1}^n h_{ij}^2$$

However, since $\mathbf{H}\mathbf{y} = \mathbf{H}\hat{\mathbf{y}}$, $\sum_{j=1}^n e_j h_{ij} = 0$. Also, since \mathbf{H} is idempotent, $\sum_{j=1}^n h_{ij}^2 = h_{ii}$. Therefore, Eq. (C.8.2) can be written as

$$\begin{aligned} (n-p-1)S_{(i)}^2 &= \sum_{j=1}^n e_j^2 + \frac{h_{ii} e_i^2}{(1-h_{ii})^2} - \frac{e_i^2}{(1-h_{ii})^2} \\ &= \sum_{j=1}^n e_j^2 - \frac{e_i^2}{1-h_{ii}} \\ &= (n-p)MS_{\text{Res}} - \frac{e_i^2}{1-h_{ii}} \end{aligned}$$

Finally, we obtain the result in Eq. (4.12), that is,

$$S_{(i)}^2 = \frac{(n-p)MS_{\text{Res}} - e_i^2/(1-h_{ii})}{n-p-1}$$

C.9 OUTLIER TEST BASED ON *R*-STUDENT

A common way to model an outlier is the **mean shift outlier model**. Suppose we fit the model $\mathbf{y} = \mathbf{X}\boldsymbol{\beta} + \boldsymbol{\varepsilon}$ when the true model is

$$\mathbf{y} = \mathbf{X}\boldsymbol{\beta} + \boldsymbol{\delta} + \boldsymbol{\varepsilon}$$

where $\boldsymbol{\delta}$ is an $n \times 1$ vector of zeros except for the u th observation, which has a value of δ_u . Thus,

$$\boldsymbol{\delta} = \begin{bmatrix} 0 \\ \vdots \\ 0 \\ \delta_u \\ 0 \\ \vdots \\ 0 \end{bmatrix}$$

For both the model we fit and the mean shift outlier model, assume that $E(\boldsymbol{\varepsilon}) \sim N(\mathbf{0}, \sigma^2\mathbf{I})$. Our goal is to find an appropriate test statistic for the hypotheses

$$H_0: \delta_u = 0, \quad H_0: \delta_u \neq 0$$

This procedure assumes that we are specifically interested in the u th observation, that is, that we have a priori information that the u th observation may be an outlier.

The first step is to find an appropriate estimate of δ_u . A logical candidate is the u th residual. Let $\mathbf{e} = [\mathbf{I} - \mathbf{X}(\mathbf{X}'\mathbf{X})^{-1}\mathbf{X}']\mathbf{y}$ be the $n \times 1$ vector of residuals. The expected value of \mathbf{e} is

$$\begin{aligned} E(\mathbf{e}) &= E\left([\mathbf{I} - \mathbf{X}(\mathbf{X}'\mathbf{X})^{-1}\mathbf{X}']\mathbf{y}\right) \\ &= [\mathbf{I} - \mathbf{X}(\mathbf{X}'\mathbf{X})^{-1}\mathbf{X}']E(\mathbf{y}) \\ &= [\mathbf{I} - \mathbf{X}(\mathbf{X}'\mathbf{X})^{-1}\mathbf{X}'][\mathbf{X}\boldsymbol{\beta} + \boldsymbol{\delta}] \\ &= [\mathbf{I} - \mathbf{X}(\mathbf{X}'\mathbf{X})^{-1}\mathbf{X}']\mathbf{X}\boldsymbol{\beta} + [\mathbf{I} - \mathbf{X}(\mathbf{X}'\mathbf{X})^{-1}\mathbf{X}']\boldsymbol{\delta} \\ &= [\mathbf{X} - \mathbf{X}]\boldsymbol{\beta} + [\mathbf{I} - \mathbf{X}(\mathbf{X}'\mathbf{X})^{-1}\mathbf{X}']\boldsymbol{\delta} \\ &= [\mathbf{I} - \mathbf{X}(\mathbf{X}'\mathbf{X})^{-1}\mathbf{X}']\boldsymbol{\delta} \end{aligned}$$

Thus,

$$E(e_u) = (-h_{uu})\delta_u$$

where h_{uu} is the u th hat diagonal or the u th diagonal element of $\mathbf{X}(\mathbf{X}'\mathbf{X})^{-1}\mathbf{X}'$. Consequently, an unbiased estimator of δ_u is

$$\hat{\delta}_u = \frac{e_u}{1-h_{uu}}$$

In Chapter 4, we showed that $\hat{\delta}_u$ is simply the u th PRESS residual. The next step is to determine the variance of our estimator. We note that

$$\begin{aligned} \text{Var}(\mathbf{e}) &= \text{Var}\left(\left[\mathbf{I} - \mathbf{X}(\mathbf{X}'\mathbf{X})^{-1}\mathbf{X}'\right]\mathbf{y}\right) \\ &= \left[\mathbf{I} - \mathbf{X}(\mathbf{X}'\mathbf{X})^{-1}\mathbf{X}'\right]\sigma^2\mathbf{I}\left[\mathbf{I} - \mathbf{X}(\mathbf{X}'\mathbf{X})^{-1}\mathbf{X}'\right]' \\ &= \sigma^2\left[\mathbf{I} - \mathbf{X}(\mathbf{X}'\mathbf{X})^{-1}\mathbf{X}'\right]\left[\mathbf{I} - \mathbf{X}(\mathbf{X}'\mathbf{X})^{-1}\mathbf{X}'\right] \\ &= \sigma^2\left[\mathbf{I} - \mathbf{X}(\mathbf{X}'\mathbf{X})^{-1}\mathbf{X}'\right] \end{aligned}$$

Thus, $\text{Var}(e_u) = (1 - h_{uu})\sigma^2$. The variance of $\hat{\delta}_u$ then is

$$\begin{aligned} \text{Var}\left(\frac{e_u}{1-h_{uu}}\right) &= \frac{1}{(1-h_{uu})^2}\text{Var}(e_u) \\ &= \frac{(1-h_{uu})\sigma^2}{(1-h_{uu})^2} = \frac{\sigma^2}{1-h_{uu}} \end{aligned}$$

We next note that \mathbf{e} is a linear combination of \mathbf{y} . Thus, \mathbf{e} is a linear combination of normally distributed random variables. As a result, \mathbf{e} follows a normal distribution, as does $\hat{\delta}_u$. Consequently, under H_0 : $\delta_u = 0$,

$$\frac{e_u/(1-h_{uu})}{\sigma/(\sqrt{1-h_{uu}})} = \frac{e_u}{\sigma\sqrt{1-h_{uu}}}$$

follows a standard normal distribution. We note that this quantity is simply an example of a studentized residual, as we saw in Chapter 4. In general, σ^2 is unknown. We have seen that MS_{Res} is an unbiased estimator of σ^2 . Further, we have seen that

$$\frac{MS_{\text{Res}}}{\sigma^2}$$

is a χ^2 random variable divided by its degrees of freedom. As a result, a candidate test statistic is

$$\frac{e_u}{\sqrt{MS_{\text{Res}}(1-h_{uu})}}$$

which follows a t distribution if $\mathbf{e} = [\mathbf{I} - \mathbf{X}(\mathbf{X}'\mathbf{X})^{-1}\mathbf{X}']\mathbf{y}$ and $SS_{\text{Res}} = \mathbf{y}'[\mathbf{I} - \mathbf{X}(\mathbf{X}'\mathbf{X})^{-1}\mathbf{X}']\mathbf{y}$ are independent. We can show that \mathbf{e} and SS_{Res} are independent if

$$[\mathbf{I} - \mathbf{X}(\mathbf{X}'\mathbf{X})^{-1}\mathbf{X}']\sigma^2\mathbf{I}[\mathbf{I} - \mathbf{X}(\mathbf{X}'\mathbf{X})^{-1}\mathbf{X}'] = \mathbf{0}$$

Unfortunately,

$$[\mathbf{I} - \mathbf{X}(\mathbf{X}'\mathbf{X})^{-1}\mathbf{X}']\sigma^2\mathbf{I}[\mathbf{I} - \mathbf{X}(\mathbf{X}'\mathbf{X})^{-1}\mathbf{X}'] = \sigma^2[\mathbf{I} - \mathbf{X}(\mathbf{X}'\mathbf{X})^{-1}\mathbf{X}'] \neq \mathbf{0}$$

The problem is that

$$SS_{\text{Res}} = \mathbf{e}'\mathbf{e} = \sum_{i=1}^n e_i^2$$

which means that SS_{Res} is correlated with each individual residual because the square of each individual residual is a component of SS_{Res} . In Section C.8 we developed an estimate of σ^2 with the u th observation deleted. This estimate is independent of e_u by the basic independence assumption on our random errors. As a result, an appropriate test statistic for the mean shift outlier model is

$$\frac{e_u}{S_{(u)}\sqrt{1-h_{uu}}}$$

which is the externally studentized residual or R -student. Under $H_0: \delta_u = 0$, this statistic follows the central t_{n-p-1} distribution, and under $H_0: \delta_u \neq 0$, this statistic follows the $t'_{n-p-1,\gamma}$ distribution, where

$$\gamma = \frac{\delta_u}{\sigma/(\sqrt{1-h_{uu}})} = \frac{\delta_u\sqrt{1-h_{uu}}}{\sigma}$$

It is important to note that the power of this test depends on h_{uu} . Recall that if we fit an intercept to our model, then $1/n \leq h_{uu} \leq 1$. Maximum power occurs when $h_{uu} = 1/n$, which is at the center of the data cloud in terms of the \mathbf{X} 's. As $h_{uu} \rightarrow 1$, the power goes to 0. In other words, this test has less ability to detect outliers at the high-leverage data points.

C.10 INDEPENDENCE OF RESIDUALS AND FITTED VALUES

We know that $\hat{\mathbf{y}} = \mathbf{X}\hat{\boldsymbol{\beta}} = \mathbf{X}(\mathbf{X}'\mathbf{X})^{-1}\mathbf{X}'\mathbf{y} = \mathbf{H}\mathbf{y}$ and $\mathbf{e} = \mathbf{y} - \hat{\mathbf{y}} = (\mathbf{I} - \mathbf{H})\mathbf{y}$. Furthermore, we assume that $\mathbf{y} \sim \mathbf{N}(\mathbf{X}\boldsymbol{\beta}, \sigma^2\mathbf{I})$. To prove that the residuals and fitted values are independent, from the new vector

$$\begin{bmatrix} \hat{\mathbf{y}} \\ \mathbf{e} \end{bmatrix} = \begin{bmatrix} \mathbf{H} \\ \mathbf{I} - \mathbf{H} \end{bmatrix} \mathbf{y} = \mathbf{M}\mathbf{y}$$

Because \mathbf{y} is multivariate normal, the new vector $\mathbf{M}\mathbf{y}$ is also multivariate normal. The expected value of $\mathbf{M}\mathbf{y}$ is

$$E(\mathbf{M}\mathbf{y}) = \mathbf{M}E(\mathbf{y}) = \begin{bmatrix} \mathbf{H} \\ \mathbf{I} - \mathbf{H} \end{bmatrix} \mathbf{X}\boldsymbol{\beta} = \begin{bmatrix} \mathbf{X}\boldsymbol{\beta} \\ \mathbf{0} \end{bmatrix}$$

The covariance matrix of $\mathbf{M}\mathbf{y}$ is

$$\begin{aligned} \text{Var}(\mathbf{M}\mathbf{y}) &= \mathbf{M} \text{Var}(\mathbf{y}) \mathbf{M}' \\ &= \sigma^2 \begin{bmatrix} \mathbf{H} \\ \mathbf{I} - \mathbf{H} \end{bmatrix} [\mathbf{H} \mid \mathbf{I} - \mathbf{H}] \\ &= \sigma^2 \begin{bmatrix} \mathbf{H}\mathbf{H} & \mathbf{H}(\mathbf{I} - \mathbf{H}) \\ (\mathbf{I} - \mathbf{H})\mathbf{H} & (\mathbf{I} - \mathbf{H})(\mathbf{I} - \mathbf{H}) \end{bmatrix} \\ &= \sigma^2 \begin{bmatrix} \mathbf{H} & \mathbf{0} \\ \mathbf{0} & \mathbf{I} - \mathbf{H} \end{bmatrix} \end{aligned}$$

Because all of the covariances between $\hat{\mathbf{y}}$ and \mathbf{e} are zero and the random variables $\hat{\mathbf{y}}$ and \mathbf{e} are jointly normally distributed, the fitted values and the residuals are independent.

C.11 GAUSS-MARKOV THEOREM, $\text{VAR}(\varepsilon) = \mathbf{V}$

The Gauss-Markov theorem establishes that the generalized least-squares (GLS) estimator of $\boldsymbol{\beta}$, $\hat{\boldsymbol{\beta}} = (\mathbf{X}'\mathbf{V}^{-1}\mathbf{X})^{-1}\mathbf{X}'\mathbf{V}^{-1}\mathbf{y}$, is BLUE (**best linear unbiased estimator**). Once again, by best, we mean $\hat{\boldsymbol{\beta}}$ minimizes the variance for any linear combination of the estimated coefficients, $\ell'\hat{\boldsymbol{\beta}}$. We note that if the model is correct,

$$\begin{aligned} E[(\mathbf{X}'\mathbf{V}^{-1}\mathbf{X})^{-1}\mathbf{X}'\mathbf{V}^{-1}\mathbf{y}] &= (\mathbf{X}'\mathbf{V}^{-1}\mathbf{X})^{-1}\mathbf{X}'\mathbf{V}^{-1}E(\mathbf{y}) \\ &= (\mathbf{X}'\mathbf{V}^{-1}\mathbf{X})^{-1}\mathbf{X}'\mathbf{V}^{-1}\mathbf{X}\boldsymbol{\beta} = \boldsymbol{\beta} \end{aligned}$$

Thus, $(\mathbf{X}'\mathbf{V}^{-1}\mathbf{X})^{-1}\mathbf{X}'\mathbf{V}^{-1}\mathbf{y}$ is an unbiased estimator of $\boldsymbol{\beta}$. The variance of this estimator is

$$\begin{aligned} \text{Var}[(\mathbf{X}'\mathbf{V}^{-1}\mathbf{X})^{-1}\mathbf{X}'\mathbf{V}^{-1}\mathbf{y}] &= [(\mathbf{X}'\mathbf{V}^{-1}\mathbf{X})^{-1}\mathbf{X}'\mathbf{V}^{-1}] \text{Var}(\mathbf{y}) [(\mathbf{X}'\mathbf{V}^{-1}\mathbf{X})^{-1}\mathbf{X}'\mathbf{V}^{-1}]' \\ &= [(\mathbf{X}'\mathbf{V}^{-1}\mathbf{X})^{-1}\mathbf{X}'\mathbf{V}^{-1}] \mathbf{V} [(\mathbf{X}'\mathbf{V}^{-1}\mathbf{X})^{-1}\mathbf{X}'\mathbf{V}^{-1}]' \\ &= [(\mathbf{X}'\mathbf{V}^{-1}\mathbf{X})^{-1}\mathbf{X}'\mathbf{V}^{-1}] \mathbf{V} [\mathbf{V}^{-1}\mathbf{X}(\mathbf{X}'\mathbf{V}^{-1}\mathbf{X})^{-1}] \\ &= (\mathbf{X}'\mathbf{V}^{-1}\mathbf{X})^{-1} \end{aligned}$$

Thus,

$$\text{Var}(\ell'\hat{\boldsymbol{\beta}}) = \ell' \text{Var}(\hat{\boldsymbol{\beta}}) \ell = \ell' [(\mathbf{X}'\mathbf{V}^{-1}\mathbf{X})^{-1}] \ell$$

Let $\tilde{\beta}$ be another unbiased estimator of β that is a linear combination of the data. Our goal, then, is to show that $\text{Var}(\ell'\tilde{\beta}) \geq \ell'(\mathbf{X}'\mathbf{V}^{-1}\mathbf{X})^{-1}\ell$ with at least one ℓ such that $\text{Var}(\ell'\tilde{\beta}) > \ell'(\mathbf{X}'\mathbf{V}^{-1}\mathbf{X})^{-1}\ell$.

We first note that we can write any other estimator of β that is a linear combination of the data as

$$\tilde{\beta} = [(\mathbf{X}'\mathbf{V}^{-1}\mathbf{X})^{-1}\mathbf{X}'\mathbf{V}^{-1} + \mathbf{B}]\mathbf{y} + \mathbf{b}_0$$

where \mathbf{B} is an $p \times n$ matrix and \mathbf{b}_0 is a $p \times 1$ vector of constants that appropriately adjusts the GLS estimator to form the alternative estimate. We next note that if the model is correct, then

$$\begin{aligned} E(\tilde{\beta}) &= E\left\{[(\mathbf{X}'\mathbf{V}^{-1}\mathbf{X})^{-1}\mathbf{X}'\mathbf{V}^{-1} + \mathbf{B}]\mathbf{y} + \mathbf{b}_0\right\} \\ &= [(\mathbf{X}'\mathbf{V}^{-1}\mathbf{X})^{-1}\mathbf{X}'\mathbf{V}^{-1} + \mathbf{B}]E(\mathbf{y}) + \mathbf{b}_0 \\ &= [(\mathbf{X}'\mathbf{V}^{-1}\mathbf{X})^{-1}\mathbf{X}'\mathbf{V}^{-1} + \mathbf{B}]\mathbf{X}\beta + \mathbf{b}_0 \\ &= (\mathbf{X}'\mathbf{V}^{-1}\mathbf{X})^{-1}\mathbf{X}'\mathbf{V}^{-1}\mathbf{X}\beta + \mathbf{B}\mathbf{X}\beta + \mathbf{b}_0 \\ &= \beta + \mathbf{B}\mathbf{X}\beta + \mathbf{b}_0 \end{aligned}$$

Consequently, $\tilde{\beta}$ is unbiased if and only if both $\mathbf{b}_0 = \mathbf{0}$ and $\mathbf{B}\mathbf{X} = \mathbf{0}$. The variance of $\tilde{\beta}$ is

$$\begin{aligned} \text{Var}(\tilde{\beta}) &= \text{Var}\left\{[(\mathbf{X}'\mathbf{V}^{-1}\mathbf{X})^{-1}\mathbf{X}'\mathbf{V}^{-1} + \mathbf{B}]\mathbf{y}\right\} \\ &= [(\mathbf{X}'\mathbf{V}^{-1}\mathbf{X})^{-1}\mathbf{X}'\mathbf{V}^{-1} + \mathbf{B}]\text{Var}(\mathbf{y})[(\mathbf{X}'\mathbf{V}^{-1}\mathbf{X})^{-1}\mathbf{X}'\mathbf{V}^{-1} + \mathbf{B}]' \\ &= [(\mathbf{X}'\mathbf{V}^{-1}\mathbf{X})^{-1}\mathbf{X}'\mathbf{V}^{-1} + \mathbf{B}]\mathbf{V}[(\mathbf{X}'\mathbf{V}^{-1}\mathbf{X})^{-1}\mathbf{X}'\mathbf{V}^{-1} + \mathbf{B}]' \\ &= [(\mathbf{X}'\mathbf{V}^{-1}\mathbf{X})^{-1}\mathbf{X}'\mathbf{V}^{-1} + \mathbf{B}]\mathbf{V}[\mathbf{V}^{-1}\mathbf{X}(\mathbf{X}'\mathbf{V}^{-1}\mathbf{X})^{-1} + \mathbf{B}'] \\ &= [(\mathbf{X}'\mathbf{V}^{-1}\mathbf{X})^{-1} + \mathbf{B}\mathbf{V}\mathbf{B}'] \end{aligned}$$

because $\mathbf{B}\mathbf{X} = \mathbf{0}$, which in turn implies that $(\mathbf{B}\mathbf{X})' = \mathbf{X}'\mathbf{B}' = \mathbf{0}$. As a result,

$$\begin{aligned} \text{Var}(\ell'\tilde{\beta}) &= \ell'\text{Var}(\tilde{\beta})\ell \\ &= \ell'[(\mathbf{X}'\mathbf{V}^{-1}\mathbf{X})^{-1} + \mathbf{B}\mathbf{V}\mathbf{B}']\ell \\ &= \ell'(\mathbf{X}'\mathbf{V}^{-1}\mathbf{X})^{-1}\ell + \ell'\mathbf{B}\mathbf{V}\mathbf{B}'\ell \\ &= \text{Var}(\ell'\tilde{\beta}) + \ell'\mathbf{B}\mathbf{V}\mathbf{B}'\ell \end{aligned}$$

We note that \mathbf{V} is a positive definite matrix. Consequently, there exists some nonsingular matrix Γ such that $\mathbf{V} = \Gamma'\Gamma$. As a result, $\mathbf{B}\mathbf{V}\mathbf{B}' = \mathbf{B}\Gamma'\Gamma\mathbf{B}'$ is at least a positive semidefinite matrix; hence, $\ell'\mathbf{B}\mathbf{V}\mathbf{B}'\ell \geq \mathbf{0}$. Next note that we can define $\ell^* = \Gamma\mathbf{B}'\ell$. As a result,

$$\ell' \mathbf{B} \mathbf{V} \mathbf{B}' \ell = \ell^{*'} \ell^* = \sum_{i=1}^p \ell_i^{*2}$$

which must be strictly greater than zero for some $\ell \neq \mathbf{0}$ unless $\mathbf{B} = \mathbf{0}$. Thus, the GLS estimate of β is the best linear unbiased estimator.

C.12 BIAS IN MS_{Res} WHEN THE MODEL IS UNDERSPECIFIED

In Section C.3.2, we have shown that if the model is correctly specified, then $E(MS_{\text{Res}}) = \sigma^2$, and thus, MS_{Res} is an unbiased estimator of σ^2 . Now, suppose we fit the model $\mathbf{y} = \mathbf{X}_p \beta_p + \boldsymbol{\varepsilon}$, where \mathbf{X}_p is the $n \times p$ model matrix associated with β_p , the vector of parameters we fit. Suppose further that the actual model is

$$\mathbf{y} = \mathbf{X}_p \beta_p + \mathbf{X}_r \beta_r + \boldsymbol{\varepsilon} + \begin{bmatrix} \mathbf{X}_p & \mathbf{X}_r \end{bmatrix} \begin{bmatrix} \beta_p \\ \beta_r \end{bmatrix} + \boldsymbol{\varepsilon}$$

where \mathbf{X}_r is the model matrix associated with β_r , the vector of important terms we did not fit, for whatever reason. For both models we assume that $E(\boldsymbol{\varepsilon}) = \mathbf{0}$ and $\text{Var}(\boldsymbol{\varepsilon}) = \sigma^2 \mathbf{I}$. In Section 10.1.2, we showed for this situation that $\hat{\beta}_p = (\mathbf{X}_p' \mathbf{X}_p)^{-1} \mathbf{X}_p' \mathbf{y}$ is a biased estimator of β_p . Consider the expected value of SS_{Res} , which is

$$\begin{aligned} E(SS_{\text{Res}}) &= E\left(\mathbf{y}' \left[\mathbf{I} - \mathbf{X}_p (\mathbf{X}_p' \mathbf{X}_p)^{-1} \mathbf{X}_p' \right] \mathbf{y}\right) \\ &= \text{trace} \left(\left[\mathbf{I} - \mathbf{X}_p (\mathbf{X}_p' \mathbf{X}_p)^{-1} \mathbf{X}_p' \right] \sigma^2 \mathbf{I} \right) \\ &\quad + [\beta_p' \beta_r'] \begin{bmatrix} \mathbf{X}_p' \\ \mathbf{X}_r' \end{bmatrix} \left[\mathbf{I} - \mathbf{X}_p (\mathbf{X}_p' \mathbf{X}_p)^{-1} \mathbf{X}_p' \right] \begin{bmatrix} \mathbf{X}_p & \mathbf{X}_r \end{bmatrix} \begin{bmatrix} \beta_p \\ \beta_r \end{bmatrix} \\ &= \sigma^2 \text{trace} \left[\mathbf{I} - \mathbf{X}_p (\mathbf{X}_p' \mathbf{X}_p)^{-1} \mathbf{X}_p' \right] \\ &\quad + [\beta_p' \beta_r'] \begin{bmatrix} \mathbf{X}_p' - \mathbf{X}_p' \mathbf{X}_p (\mathbf{X}_p' \mathbf{X}_p)^{-1} \mathbf{X}_p' \\ \mathbf{X}_r' \mathbf{X}_r - \mathbf{X}_r' \mathbf{X}_p (\mathbf{X}_p' \mathbf{X}_p)^{-1} \mathbf{X}_p' \end{bmatrix} \begin{bmatrix} \mathbf{X}_p & \mathbf{X}_r \end{bmatrix} \begin{bmatrix} \beta_p \\ \beta_r \end{bmatrix} \\ &= (n-p)\sigma^2 + [\beta_p' \beta_r'] \begin{bmatrix} \mathbf{0}' \\ \mathbf{X}_r' \mathbf{X}_r - \mathbf{X}_r' \mathbf{X}_p (\mathbf{X}_p' \mathbf{X}_p)^{-1} \mathbf{X}_p' \end{bmatrix} \begin{bmatrix} \mathbf{X}_p & \mathbf{X}_r \end{bmatrix} \begin{bmatrix} \beta_p \\ \beta_r \end{bmatrix} \\ &= (n-p)\sigma^2 + [\beta_p' \beta_r'] \begin{bmatrix} \mathbf{0} & \mathbf{0} \\ \mathbf{0} & \mathbf{X}_r' \mathbf{X}_r - \mathbf{X}_r' \mathbf{X}_p (\mathbf{X}_p' \mathbf{X}_p)^{-1} \mathbf{X}_p' \end{bmatrix} \begin{bmatrix} \beta_p \\ \beta_r \end{bmatrix} \\ &= (n-p)\sigma^2 + \beta_r' \left[\mathbf{X}_r' \mathbf{X}_r - \mathbf{X}_r' \mathbf{X}_p (\mathbf{X}_p' \mathbf{X}_p)^{-1} \mathbf{X}_p' \mathbf{X}_r \right] \beta_r \end{aligned}$$

The expected value for MS_{Res} in this situation is

$$E(MS_{\text{Res}}) = E\left(\frac{SS_{\text{Res}}}{n-p}\right) = \sigma^2 + \frac{\beta_r' \left[\mathbf{X}_r' \mathbf{X}_r - \mathbf{X}_r' \mathbf{X}_p (\mathbf{X}_p' \mathbf{X}_p)^{-1} \mathbf{X}_p' \mathbf{X}_r \right] \beta_r}{n-p}$$

As a result, MS_{Res} is not an unbiased estimator of σ^2 when the model is underspecified. The bias is

$$\frac{\boldsymbol{\beta}'_r [\mathbf{X}'_r \mathbf{X}_r - \mathbf{X}'_r \mathbf{X}_p (\mathbf{X}'_p \mathbf{X}_p)^{-1} \mathbf{X}'_p] \boldsymbol{\beta}_r}{n-p}$$

C.13 COMPUTATION OF INFLUENCE DIAGNOSTICS

In this section we will develop the very useful computational forms of the influence diagnostics *DFFITs*, *DFBETAS*, and Cook's *D* given initially in Chapter 6.

C.13.1 *DFFITs*

Recall from Eq. (6.9) that

$$DFFITs_i = \frac{\hat{y}_i - \hat{y}_{(i)}}{\sqrt{S_{(i)}^2 h_{ii}}}, \quad i = 1, 2, \dots, n \quad (\text{C.13.1})$$

Also, from Section C.8, we have

$$\hat{\boldsymbol{\beta}}_i - \hat{\boldsymbol{\beta}}_{(i)} = \frac{(\mathbf{X}'\mathbf{X})^{-1} \mathbf{x}_i e_i}{1 - h_{ii}} \quad (\text{C.13.2})$$

Multiplying both sides of Eq. (C.13.2) by \mathbf{x}'_i produces

$$\hat{y}_i - \hat{y}_{(i)} = \frac{h_{ii} e_i}{1 - h_{ii}} \quad (\text{C.13.3})$$

Dividing both sides of Eq. (C.13.3) by $\sqrt{S_{(i)}^2 h_{ii}}$ will produce *DFFITs*_{*i*}:

$$\begin{aligned} DFFITs_i &= \frac{\hat{y}_i - \hat{y}_{(i)}}{\sqrt{S_{(i)}^2 h_{ii}}} = \frac{h_{ii} e_i}{1 - h_{ii}} \left[\frac{1}{S_{(i)}^2 h_{ii}} \right]^{1/2} \\ &= \frac{e_i}{\sqrt{S_{(i)}^2 (1 - h_{ii})}} \left(\frac{h_{ii}}{1 - h_{ii}} \right)^{1/2} \\ &= t_i \left(\frac{h_{ii}}{1 - h_{ii}} \right)^{1/2} \end{aligned} \quad (\text{C.13.4})$$

where t_i is *R*-student.

C.13.2 Cook's *D*_{*i*}

We may use Eq. (C.13.2) to develop a computational form for Cook's *D*_{*i*}. Recall that Cook's *D*_{*i*} statistic is

$$D_i = \frac{(\hat{\boldsymbol{\beta}}_i - \hat{\boldsymbol{\beta}}_{(i)})' \mathbf{X}'\mathbf{X} (\hat{\boldsymbol{\beta}}_i - \hat{\boldsymbol{\beta}}_{(i)})}{pMS_{\text{Res}}}, \quad i = 1, 2, \dots, n \quad (\text{C.13.5})$$

Using Eq. (C.13.2) in Eq. (C.13.5), we obtain

$$\begin{aligned}
 D_i &= \frac{\mathbf{x}'_i(\mathbf{X}'\mathbf{X})^{-1}(\mathbf{X}'\mathbf{X})(\mathbf{X}'\mathbf{X})^{-1}\mathbf{x}_i e_i^2}{(1-h_{ii})^2 pMS_{\text{Res}}} \\
 &= \left(\frac{e_i}{1-h_{ii}}\right)^2 \left(\frac{h_{ii}}{pMS_{\text{Res}}}\right) \\
 &= \frac{r_i^2}{p} \left(\frac{h_{ii}}{1-h_{ii}}\right)
 \end{aligned}$$

where r_i is the studentized residual.

C.13.3 $DFBETAS_{j,i}$

The $DFBETAS_{j,i}$ statistic is defined in Eq. (6.7) as

$$DFBETAS_{j,i} = \frac{\hat{\beta}_j - \hat{\beta}_{j(i)}}{\sqrt{S_{(i)}^2 C_{jj}}}$$

Thus, $DFBETAS_{j,i}$ is just the j th element of $\hat{\boldsymbol{\beta}} - \hat{\boldsymbol{\beta}}_{(i)}$ in Eq. (C.13.2) divided by a standardization factor. Now

$$\hat{\beta}_j - \hat{\beta}_{j(i)} = \frac{r_{j,i} e_i}{1-h_{ii}} \tag{C.13.6}$$

and recall that $\mathbf{R} = (\mathbf{X}'\mathbf{X})^{-1}\mathbf{X}$, so that

$$(\mathbf{R}\mathbf{R}')' = [(\mathbf{X}'\mathbf{X})^{-1}\mathbf{X}'\mathbf{X}(\mathbf{X}'\mathbf{X})^{-1}]' = (\mathbf{X}'\mathbf{X})^{-1} = \mathbf{C} = \mathbf{R}'\mathbf{R}$$

Therefore, $C_{jj} = \mathbf{r}'_j \mathbf{r}_j$, so we may write the standardization factor

$$\sqrt{S_{(i)}^2 C_{jj}} = \sqrt{S_{(i)}^2 \mathbf{r}'_j \mathbf{r}_j}$$

Finally, the computation form of $DFBETAS_{j,i}$ is

$$DFBETAS_{j,i} = \frac{\hat{\beta}_j - \hat{\beta}_{j(i)}}{\sqrt{S_{(i)}^2 C_{jj}}} = \left[\frac{r_{j,i} e_i}{1-h_{ii}} \right] \frac{1}{\sqrt{S_{(i)}^2 \mathbf{r}'_j \mathbf{r}_j}} = \frac{\mathbf{r}_{j,i}}{\sqrt{\mathbf{r}'_j \mathbf{r}_j}} \frac{t_i}{\sqrt{1-h_{ii}}}$$

where t_i is R -student.

C.14 GENERALIZED LINEAR MODELS

C.14.1 Parameter Estimation in Logistic Regression

The log-likelihood for a logistic regression model was given in Eq. (14.8) as

$$\ln L(\mathbf{y}, \boldsymbol{\beta}) = \sum_{i=1}^n y_i \mathbf{x}'_i \boldsymbol{\beta} - \sum_{i=1}^n \ln[1 + \exp(\mathbf{x}'_i \boldsymbol{\beta})]$$

In many applications of logistic regression models we have repeated observations or trials at each level of the x variables. Let y_i represent the number of 1's observed for the i th observation and n_i be the number of trials at each observation. Then the log-likelihood becomes

$$\ln L(\mathbf{y}, \boldsymbol{\beta}) = \sum_{i=1}^n y_i \pi_i - \sum_{i=1}^n n_i \ln(1 - \pi_i) - \sum_{i=1}^n y_i \ln(\pi_i)$$

The maximum-likelihood estimates (MLEs) may be computed using an iteratively reweighted least-squares (IRLS) algorithm. To see this recall that the MLEs are the solutions to

$$\frac{\partial L}{\partial \boldsymbol{\beta}} = \mathbf{0}$$

which can be expressed as

$$\frac{\partial L}{\partial \pi_i} \frac{\partial \pi_i}{\partial \boldsymbol{\beta}} = \mathbf{0}$$

Note that

$$\frac{\partial L}{\partial \pi_i} = \sum_{i=1}^n \frac{n_i}{\pi_i} - \sum_{i=1}^n \frac{n_i}{1 - \pi_i} + \sum_{i=1}^n \frac{y_i}{1 - \pi_i}$$

and

$$\frac{\partial \pi_i}{\partial \boldsymbol{\beta}} = \left\{ \frac{\exp(\mathbf{x}'_i \boldsymbol{\beta})}{1 + \exp(\mathbf{x}'_i \boldsymbol{\beta})} - \left[\frac{\exp(\mathbf{x}'_i \boldsymbol{\beta})}{1 + \exp(\mathbf{x}'_i \boldsymbol{\beta})} \right]^2 \right\} \mathbf{x}_i$$

Putting this all together gives

$$\begin{aligned} \frac{\partial L}{\partial \boldsymbol{\beta}} &= \left[\sum_{i=1}^n \frac{n_i}{\pi_i} - \sum_{i=1}^n \frac{n_i}{1 - \pi_i} + \sum_{i=1}^n \frac{y_i}{1 - \pi_i} \right] \pi_i (1 - \pi_i) \mathbf{x}_i \\ &= \sum_{i=1}^n \left[\frac{y_i}{\pi_i} - \frac{n_i}{1 - \pi_i} + \frac{y_i}{1 - \pi_i} \right] \pi_i (1 - \pi_i) \mathbf{x}_i \\ &= \sum_{i=1}^n (y_i - n_i \pi_i) \mathbf{x}_i \end{aligned}$$

Therefore, the maximum-likelihood estimator solves

$$\mathbf{X}'(\mathbf{y} - \boldsymbol{\mu}) = \mathbf{0}$$

where $\mathbf{y}' = [y_1, y_2, \dots, y_n]$ and $\boldsymbol{\mu}' = [n_1 \pi_1, n_2 \pi_2, \dots, n_n \pi_n]$. This set of equations is often called the **maximum-likelihood score equations**. They are actually the same form of

the normal equations that we have seen previously for linear least squares, because in the linear regression model, $E(\mathbf{y}) = \mathbf{X}\boldsymbol{\beta} = \boldsymbol{\mu}$ and the normal equations are

$$\mathbf{X}'\mathbf{X}\hat{\boldsymbol{\beta}} = \mathbf{X}'\mathbf{y}$$

which can be written as

$$\mathbf{X}'(\mathbf{y} - \mathbf{X}\boldsymbol{\beta}) = \mathbf{0}$$

$$\mathbf{X}'(\mathbf{y} - \boldsymbol{\mu}) = \mathbf{0}$$

The **Newton-Raphson** method is actually used to solve the score equations for the logistic regression model. This procedure observes that in the neighborhood of the solution, we can use a first-order Taylor series expansion to form the approximation

$$p_i - \pi_i \approx \left(\frac{\partial \pi_i}{\partial \boldsymbol{\beta}} \right)' (\boldsymbol{\beta}^* - \boldsymbol{\beta}) \quad (\text{C.14.1})$$

where

$$p_i = \frac{y_i}{n_i}$$

and $\boldsymbol{\beta}^*$ is the value of $\boldsymbol{\beta}$ that solves the score equations. Now $\eta_i = \mathbf{x}'_i\boldsymbol{\beta}$, and

$$\frac{\partial \eta_i}{\partial \boldsymbol{\beta}} = \mathbf{x}_i$$

We note that

$$\pi_i = \frac{\exp(\eta_i)}{1 + \exp(\eta_i)}$$

By the chain rule

$$\frac{\partial \pi_i}{\partial \boldsymbol{\beta}} = \frac{\partial \pi_i}{\partial \eta_i} \frac{\partial \eta_i}{\partial \boldsymbol{\beta}} = \frac{\partial \pi_i}{\partial \eta_i} \mathbf{x}_i$$

Therefore, we can rewrite Eq. (C.14.1) as

$$\begin{aligned} p_i - \pi_i &\approx \left(\frac{\partial \pi_i}{\partial \eta_i} \right) \mathbf{x}'_i (\boldsymbol{\beta}^* - \boldsymbol{\beta}) \\ p_i - \pi_i &\approx \left(\frac{\partial \pi_i}{\partial \eta_i} \right) (\mathbf{x}'_i \boldsymbol{\beta}^* - \mathbf{x}'_i \boldsymbol{\beta}) \\ p_i - \pi_i &\approx \left(\frac{\partial \pi_i}{\partial \eta_i} \right) (\eta_i^* - \eta_i) \end{aligned} \quad (\text{C.14.2})$$

where η_i^* is the value of η_i evaluated at β^* . We note that

$$(y_i - n_i\pi_i) = (n_i p_i - n_i\pi_i) = n_i(p_i - \pi_i)$$

and since

$$\pi_i = \frac{\exp(\eta_i)}{1 + \exp(\eta_i)}$$

we can write

$$\frac{\partial \pi_i}{\partial \beta} = \frac{\exp(\eta_i)}{1 + \exp(\eta_i)} \left[\frac{\exp(\eta_i)}{1 + \exp(\eta_i)} \right]^2$$

Consequently,

$$y_i - n_i\pi_i \approx [n_i\pi_i(1 - \pi_i)] = (\eta_i^* - \eta_i)$$

Now the variance of the linear predictor $\eta_i^* = \mathbf{x}_i' \beta^*$ is, to a first approximation,

$$\text{Var}(\eta_i^*) \approx \frac{1}{n_i\pi_i(1 - \pi_i)}$$

Thus,

$$y_i - n_i\pi_i \approx \left[\frac{1}{\text{Var}(\eta_i^*)} \right] (\eta_i^* - \eta_i) = 0$$

and we may rewrite the score equations as

$$\sum_{i=1}^n \left[\frac{1}{\text{Var}(\eta_i)} \right] (\eta_i^* - \eta_i) = 0$$

or, in matrix notation,

$$\mathbf{X}' \mathbf{V}^{-1} (\boldsymbol{\eta}^* - \boldsymbol{\eta}) = \mathbf{0}$$

where \mathbf{V} is a diagonal matrix of the weights formed from the variances of the η_i . Because $\boldsymbol{\eta} = \mathbf{X}\boldsymbol{\beta}$ we may write the score equations as

$$\mathbf{X}' \mathbf{V}^{-1} (\boldsymbol{\eta}^* - \mathbf{X}\boldsymbol{\beta}) = \mathbf{0}$$

and the maximum-likelihood estimate of $\boldsymbol{\beta}$ is

$$\hat{\boldsymbol{\beta}} = (\mathbf{X}' \mathbf{V}^{-1} \mathbf{X})^{-1} \mathbf{X}' \mathbf{V}^{-1} \boldsymbol{\eta}^*$$

However, there is a problem because we do not know η^* . Our solution to this problem uses Eq. (C.14.2):

$$p_i - \pi_i \approx \left(\frac{\partial \pi_i}{\partial \eta_i} \right) (\eta_i^* - \eta_i)$$

which we can solve for η_i^* ,

$$\eta_i^* \approx \eta_i + (p_i - \pi_i) \frac{\partial \eta_i}{\partial \pi_i}$$

Let $z_i = \eta_i + (p_i - \pi_i)(\partial \eta_i / \partial \pi_i)$ and $z' = [z_1, z_2, \dots, z_n]$. Then the Newton-Raphson estimate of β is

$$\hat{\beta} = (\mathbf{X}'\mathbf{V}^{-1}\mathbf{X})^{-1} \mathbf{X}'\mathbf{V}^{-1}\mathbf{z}$$

Note that the random portion of z_i is

$$(p_i - \pi_i) \frac{\partial \eta_i}{\partial \pi_i}$$

Thus,

$$\begin{aligned} \text{Var} \left[(p_i - \pi_i) \frac{\partial \eta_i}{\partial \pi_i} \right] &= \left[\frac{\pi_i(1 - \pi_i)}{n_i} \right] \left(\frac{\partial \eta_i}{\partial \pi_i} \right)^2 \\ &= \left[\frac{\pi_i(1 - \pi_i)}{n_i} \right] \left(\frac{1}{\pi_i(1 - \pi_i)} \right)^2 \\ &= \frac{1}{n_i \pi_i (1 - \pi_i)} \end{aligned}$$

So \mathbf{V} is the diagonal matrix of weights formed from the variances of the random part of z . Thus, the IRLS algorithm based on the Newton–Raphson method can be described as follows:

1. Use ordinary least squares to obtain an initial estimate of β , say $\hat{\beta}_0$.
2. Use $\hat{\beta}_0$ to estimate \mathbf{V} and π .
3. Let $\eta_0 = \mathbf{X}\hat{\beta}_0$.
4. Base z_1 on η_0 .
5. Obtain a new estimate $\hat{\beta}_1$, and iterate until some suitable convergence criterion is satisfied.

C.14.2 Exponential Family

It is easy to show that the normal, binomial, and Poisson distributions are members of the exponential family. Recall that the exponential family of distributions is defined by Eq. (13.48), repeated below for convenience:

$$f(y_i, \theta_i, \phi) = \exp\{[y_i\theta_i - b(\theta_i)]/a(\phi) + h(y_i, \phi)\}$$

1. The Normal Distribution

$$\begin{aligned} f(y_i, \theta_i, \phi) &= \frac{1}{2\pi\sigma^2} \exp\left(-\frac{1}{2\sigma^2}(y-\mu)^2\right) \\ &= \exp\left[-\ln(2\pi\sigma^2) - \frac{y^2}{2\sigma^2} + \frac{y\mu}{\sigma^2} - \frac{\mu^2}{2\sigma^2}\right] \\ &= \exp\left[\frac{1}{\sigma^2}\left(-\frac{y^2}{2} + y\mu - \frac{\mu^2}{2}\right) - \frac{1}{2}\ln(2\pi\sigma^2)\right] \\ &= \exp\left[\frac{1}{\sigma^2}\left(y\mu - \frac{\mu^2}{2}\right) - \frac{y^2}{2\sigma^2} - \frac{1}{2}\ln(2\pi\sigma^2)\right] \end{aligned}$$

Thus, for the normal distribution, we have

$$\begin{aligned} \theta_i &= \mu, \quad b(\theta_i) = \frac{\mu^2}{2}, \quad a(\phi) = \sigma^2 \\ h(y_i, \phi) &= -\frac{y^2}{2\sigma^2} - \frac{1}{2}\ln(2\pi\sigma^2) \\ E(y) &= \frac{db(\theta_i)}{d\theta_i} = \mu, \quad \text{Var}(y) = \frac{d^2b(\theta_i)}{d\theta_i^2} a(\phi) = \sigma^2 \end{aligned}$$

2. The Binomial Distribution

$$\begin{aligned} f(y_i, \theta_i, \phi) &= \binom{n}{m} \pi^y (1-\pi)^{n-y} \\ &= \exp\left\{\ln\binom{n}{y} + y\ln\pi + (n-y)\ln(1-\pi)\right\} \\ &= \exp\left\{\ln\binom{n}{y} + y\ln\pi + n\ln(1-\pi) - y\ln(1-\pi)\right\} \\ &= \exp\left\{y\ln\left(\frac{\pi}{1-\pi}\right) + n\ln(1-\pi) + \ln\binom{n}{y}\right\} \end{aligned}$$

Therefore, for the binomial distribution,

$$\theta_i = \ln\left[\frac{\pi}{1-\pi}\right], \quad \pi = \frac{\exp(\theta_i)}{1 + \exp(\theta_i)}$$

$$b(\theta_i) = n \ln(1 - \pi), \quad a(\phi) = 1, \quad h(y_i, \phi) = \ln \binom{n}{y}$$

$$E(y) = \frac{db(\theta_i)}{d\theta_i} = \frac{db(\theta_i)}{d\pi} \frac{d\pi}{d\theta_i}$$

We note that

$$\frac{d\pi}{d\theta_i} = \frac{\exp(\theta_i)}{1 + \exp(\theta_i)} - \left[\frac{\exp(\theta_i)}{1 + \exp(\theta_i)} \right]^2 = \pi(1 - \pi)$$

Therefore,

$$E(y) = \left(\frac{n}{1 - \pi} \right) \pi(1 - \pi) = n\pi$$

We recognize this as the mean of the binomial distribution. Also,

$$\text{Var}(y) = \frac{dE(y)}{d\theta_i} = \frac{dE(y)}{d\pi} \frac{d\pi}{d\theta_i} = n\pi(1 - \pi)$$

This last expression is just the variance of the binomial distribution.

3. *The Poisson Distribution*

$$f(y_i, \theta_i, \phi) = \frac{\lambda^y e^{-\lambda}}{y!} = \exp[y \ln \lambda - \lambda \ln(y!)]$$

Therefore, for the Poisson distribution, we have

$$\theta_i = \ln(\lambda) \quad \text{and} \quad \lambda = \exp(\theta_i)$$

$$b(\theta_i) = \lambda$$

$$a(\phi) = 1$$

$$h(y_i, \phi) = -\ln(y!)$$

Now

$$E(y) = \frac{db(\theta_i)}{d\theta_i} = \frac{db(\theta_i)}{d\lambda} \frac{d\lambda}{d\theta_i}$$

However, since

$$\frac{d\lambda}{d\theta_i} = \exp(\theta_i) = \lambda$$

the mean of the Poisson distribution is

$$E(y) = 1 \cdot \lambda = \lambda$$

The variance of the Poisson distribution is

$$\text{Var}(y) = \frac{dE(y)}{d\theta_i} = \lambda$$

C.14.3 Parameter Estimation in the Generalized Linear Model

Consider the method of maximum likelihood applied to the GLM, and suppose we use the canonical link. The log-likelihood function is

$$\ell(\mathbf{y}, \boldsymbol{\beta}) = \frac{\sum_{i=1}^n [y_i \theta_i - b(\theta_i)]}{a(\phi)} + h(y_i, \phi)$$

For the canonical link, we have $\eta_i = g[E(y_i)] = g(\mu_i) = \mathbf{x}'_i \boldsymbol{\beta}$; therefore,

$$\frac{\partial \ell}{\partial \boldsymbol{\beta}} = \frac{\partial \ell}{\partial \theta_i} \frac{\partial \theta_i}{\partial \boldsymbol{\beta}} = \frac{1}{a(\phi)} \sum_{i=1}^n \left[y_i - \frac{db(\theta_i)}{d\theta_i} \right] \mathbf{x}_i = \frac{1}{a(\phi)} \sum_{i=1}^n (y_i - \mu_i) \mathbf{x}_i$$

Consequently, we can find the maximum-likelihood estimates of the parameters by solving the system of equations

$$\frac{1}{a(\phi)} \sum_{i=1}^n (y_i - \mu_i) \mathbf{x}_i = \mathbf{0}$$

In most cases, $a(\phi)$ is a constant, so these equations become

$$\sum_{i=1}^n (y_i - \mu_i) \mathbf{x}_i = \mathbf{0}$$

This is actually a **system** of $p = k + 1$ equations, one for each model parameter. In matrix form, these equations are

$$\mathbf{X}'(\mathbf{y} - \boldsymbol{\mu}) = \mathbf{0}$$

where $\boldsymbol{\mu}' = [\mu_1, \mu_2, \dots, \mu_p]$. These are called the maximum-likelihood score equations, and they are just the same equations that we saw previously in the case of logistic regression, where $\boldsymbol{\mu}' = [n_1 \pi_1, n_2 \pi_2, \dots, n_n \pi_n]$.

To solve the score equations, we can use IRLS, just as we did in the case of logistic regression. We start by finding a first-order Taylor series approximation in the neighborhood of the solution

$$y_i - \mu_i \approx \frac{d\mu_i}{d\eta_i}(\eta_i^* - \eta_i)$$

Now for a canonical link $\eta_i = \theta_i$, and

$$y_i - \mu_i \approx \frac{d\mu_i}{d\theta_i}(\eta_i^* - \eta_i) \tag{C.14.3}$$

Therefore, we have

$$\eta_i^* - \eta_i \approx (y_i - \mu_i) \frac{d\theta_i}{d\mu_i}$$

This expression provides a basis for approximating the variance of $\hat{\eta}_i$.

In maximum-likelihood estimation, we replace η_i by its estimate, $\hat{\eta}_i$. Then we have

$$\text{Var}(\eta_i^* - \eta_i) \approx \text{Var}\left[(y_i - \mu_i) \frac{d\theta_i}{d\mu_i}\right]$$

Since η_i^* and μ_i are constants,

$$\text{Var}(\hat{\eta}_i) \approx \left[\frac{d\theta_i}{d\mu_i}\right]^2 \text{Var}(y_i)$$

But

$$\frac{d\theta_i}{d\mu_i} = \frac{1}{\text{Var}(\mu_i)}$$

where $\text{Var}(y_i) = \text{Var}(\mu_i)a(\phi)$. Consequently,

$$\begin{aligned} \text{Var}(\hat{\eta}_i) &\approx \left[\frac{1}{\text{Var}(\mu_i)}\right]^2 \text{Var}(\mu_i)a(\phi) \\ &\approx \frac{1}{\text{Var}(\mu_i)} a(\phi) \end{aligned}$$

For convenience, define $\text{Var}(\eta_i) = [\text{Var}(\mu_i)]^{-1}$, so we have

$$\text{Var}(\hat{\eta}_i) \approx \text{Var}(\hat{\eta}_i)a(\phi)$$

Substituting this into Eq. (C.14.3) results in

$$y_i - \mu_i \approx \frac{1}{\text{Var}(\eta_i)}(\eta_i^* - \eta) \tag{C.14.4}$$

If we let \mathbf{V} be an $n \times n$ diagonal matrix whose diagonal elements are the $\text{Var}(\eta_i)$, then in matrix form, Eq. (C.14.4) becomes

$$\mathbf{y} - \boldsymbol{\mu} \approx \mathbf{V}^{-1}(\boldsymbol{\eta}^* - \boldsymbol{\eta})$$

We may then rewrite the score equations as follows:

$$\begin{aligned}\mathbf{X}'(\mathbf{y} - \boldsymbol{\mu}) &= \mathbf{0} \\ \mathbf{X}'\mathbf{V}^{-1}(\boldsymbol{\eta}^* - \boldsymbol{\eta}) &= \mathbf{0} \\ \mathbf{X}'\mathbf{V}^{-1}(\boldsymbol{\eta}^* - \mathbf{X}\boldsymbol{\beta}) &= \mathbf{0}\end{aligned}$$

Thus, the maximum-likelihood estimate of $\boldsymbol{\beta}$ is

$$\hat{\boldsymbol{\beta}} = (\mathbf{X}'\mathbf{V}^{-1}\mathbf{X})^{-1}\mathbf{X}'\mathbf{V}^{-1}\boldsymbol{\eta}^*$$

Now just as we saw in the logistic regression situation, we do not know $\boldsymbol{\eta}^*$, so we pursue an iterative scheme based on

$$z_i = \hat{\eta}_i + (y_i - \hat{\mu}_i) \frac{d\eta_i}{d\mu_i}$$

Using iteratively reweighted least squares with the Newton–Raphson method, the solution is found from

$$\hat{\boldsymbol{\beta}} = (\mathbf{X}'\mathbf{V}^{-1}\mathbf{X})^{-1}\mathbf{X}'\mathbf{V}^{-1}\mathbf{z}$$

Asymptotically, the random component of \mathbf{z} comes from the observations y_i . The diagonal elements of the matrix \mathbf{V} are the variances of the z_i 's, apart from $a(\phi)$.

As an example, consider the logistic regression case:

$$\begin{aligned}\eta_i &= \ln\left(\frac{\pi_i}{1-\pi_i}\right) \\ \frac{d\eta_i}{d\mu_i} &= \frac{d\eta_i}{d\pi_i} = \frac{d \ln[\pi_i/(1-\pi_i)]}{d\pi_i} \\ &= \frac{1-\pi_i}{\pi_i} \left[\frac{\pi_i}{1-\pi_i} + \frac{\pi_i}{(1-\pi_i)^2} \right] \\ &= \frac{1-\pi_i}{\pi_i(1-\pi_i)} \left[1 + \frac{\pi_i}{1-\pi_i} \right] \\ &= \frac{1}{\pi_i} \left[\frac{1-\pi_i + \pi_i}{1-\pi_i} \right] = \frac{1}{\pi_i(1-\pi_i)}\end{aligned}$$

Thus, for logistic regression, the diagonal elements of the matrix \mathbf{V} are

$$\left(\frac{d\eta_i}{d\mu_i}\right)^2 \text{Var}(y_i) = \left[\frac{1}{\pi_i(1-\pi_i)}\right]^2 \frac{\pi_i(1-\pi_i)}{n_i} = \frac{1}{n_i\pi_i(1-\pi_i)}$$

which is exactly what we obtained previously.

Therefore, IRLS based on the Newton–Raphson method can be described as follows:

1. Use ordinary least squares to obtain an initial estimate of $\boldsymbol{\beta}$, say $\hat{\boldsymbol{\beta}}_0$.
2. Use $\hat{\boldsymbol{\beta}}_0$ to estimate \mathbf{V} and $\boldsymbol{\mu}$.
3. Let $\boldsymbol{\eta}_0 = \mathbf{X}\hat{\boldsymbol{\beta}}_0$.
4. Base \mathbf{z}_1 on $\boldsymbol{\eta}_0$.
5. Obtain a new estimate $\hat{\boldsymbol{\beta}}_1$, and iterate until some suitable convergence criterion is satisfied.

If we do not use the canonical link, then $\eta_i \neq \theta_i$, and the appropriate derivative of the log-likelihood is

$$\frac{\partial \ell}{\partial \boldsymbol{\beta}} = \frac{d\ell}{d\theta_i} \frac{d\theta_i}{d\mu_i} \frac{d\mu_i}{d\eta_i} \frac{d\eta_i}{\partial \boldsymbol{\beta}}$$

Note that:

1. $\frac{d\ell}{d\theta_i} = \frac{1}{a(\phi)} \left[y_i - \frac{db(\theta_i)}{d\theta_i} \right] = \frac{1}{a(\phi)} (y_i - \mu_i)$
2. $\frac{d\theta_i}{d\mu_i} = \frac{1}{\text{var}(\mu_i)}$
3. $\frac{d\eta_i}{\partial \boldsymbol{\beta}} = \mathbf{x}_i$

Putting this all together yields

$$\frac{\partial \ell}{\partial \boldsymbol{\beta}} = \frac{y_i - \mu_i}{a(\phi)} \frac{1}{\text{Var}(\mu_i)} \frac{d\mu_i}{d\eta_i} \mathbf{x}_i$$

Once again, we can use a Taylor series expansion to obtain

$$y_i - \mu_i \approx \frac{d\mu_i}{d\eta_i} (\eta_i^* - \eta_i)$$

Following an argument similar to that employed before,

$$\text{Var}(\hat{\eta}_i) \approx \left[\frac{d\theta_i}{d\mu_i} \right]^2 \text{Var}(y_i)$$

and eventually we can show that

$$\frac{\partial \ell}{\partial \boldsymbol{\beta}} = \sum_{i=1}^n \frac{\eta_i^* - \eta_i}{a(\phi) \text{Var}(\eta_i)} \mathbf{x}_i$$

Equating this last expression to zero and writing it in matrix form, we obtain

$$\mathbf{X}' \mathbf{V}^{-1} (\boldsymbol{\eta}^* - \boldsymbol{\eta}) = \mathbf{0}$$

or, since $\boldsymbol{\eta} = \mathbf{X}\boldsymbol{\beta}$,

$$\mathbf{X}' \mathbf{V}^{-1} (\boldsymbol{\eta}^* - \mathbf{X}\boldsymbol{\beta}) = \mathbf{0}$$

The Newton–Raphson solution is based on

$$\hat{\boldsymbol{\beta}} = (\mathbf{X}' \mathbf{V}^{-1} \mathbf{X})^{-1} \mathbf{X}' \mathbf{V}^{-1} \mathbf{z}$$

where

$$z_i = \hat{\eta}_i + (y_i - \hat{\mu}_i) \frac{d\eta_i}{d\mu_i}$$

Just as in the case of the canonical link, the matrix \mathbf{V} is a diagonal matrix formed from the variances of the estimated linear predictors, apart from $a(\phi)$.

APPENDIX D

INTRODUCTION TO SAS

- D.1 Basic Data Entry
- D.2 Creating Permanent SAS Data Sets
- D.3 Importing Data from an EXCEL File
- D.4 Output Command
- D.5 Log File
- D.6 Adding Variables to an Existing SAS Data Set

One of the hardest parts about learning SAS is creating data sets. For the most part, this appendix deals with data set creation. It is vital to note that the default data set used by SAS at any given time is the data set most recently created. We can specify the data set for any SAS procedure (PROC). Suppose we wish to do multiple regression analysis on a data set named *delivery*. The appropriate PROC REG statement is

```
proc reg data=delivery;
```

We now consider in more detail how to create SAS data sets.

D.1 BASIC DATA ENTRY

A. Using the SAS Editor Window

The easiest way to enter data into SAS is to use the SAS Editor. We will use the delivery time data, given in Table 3.2 as the example throughout this appendix.

Step 1: Open the SAS Editor Window The SAS Editor window opens automatically upon starting the Windows or UNIX versions of SAS.

Step 2: The Data Command Each SAS data set requires a name, which the data statement provides. This appendix uses a convention whereby all capital letters within a SAS command indicates a name the user must provide. The simplest form of the data statement is

```
data NAME;
```

The most painful lesson learning SAS is the use of the semicolon (;). Each SAS command must end in a semicolon. It seems like 95% of the mistakes made by SAS novices is to forget the semicolon. SAS is merciless about the use of the semicolon! For the delivery time data, an appropriate data command is

```
data delivery;
```

Later, we will discuss appropriate options for the data command.

Step 3: The Input Command The input command tells SAS the name of each variable in the data set. SAS assumes that each variable is numeric. The general form of the input command is

```
input VAR1 VAR2 ... ;
```

We first consider the command when all of the variables are numeric, as in the delivery data from Chapter 2:

```
input time cases distance;
```

We designate a variable as alphanumeric (contains some characters other than numbers) by placing a \$ after the variable name. For example, suppose we know the delivery person's name for each delivery. We could modify these names through the following input command:

```
input time cases distance person $;
```

Step 4: Give the Actual Data We alert SAS to the actual data by either the cards (which is fairly archaic), or the lines commands. The simplest way to enter the data is in space-delimited form. Each line represents a row from Table 3.2. **Do not place a semicolon (;) at the end of the data rows.** Many SAS users do place a semicolon

on a row unto itself after the data to indicate the end of the data set. This semicolon is not required, but many people consider it good practice. For the delivery data, the actual data portion of the SAS code follows:

```
cards;
16.68      7      560
11.50      3      220
12.03      3      340
14.88      4       80
13.75      6      150
18.11      7      330
 8.00      2      110
17.83      7      210
79.24     30     1460
21.50      5      605
40.33     16      688
21.00     10      215
13.50      4      255
19.75      6      462
24.00      9      448
29.00     10      776
15.35      6      200
19.00      7      132
 9.50      3       36
35.10     17      770
17.90     10      140
52.32     26      810
18.75      9      450
19.83      8      635
10.75      4      150
;
```

Step 5: Using PROC PRINT to Check Data Entry It is very easy to make mistakes in entering data. If the data set is sufficiently small, it is always wise to print it. The simplest statement to print a data set in SAS is

```
proc print;
```

which prints the most recently created data set. This statement prints the entire data set. If we wish to print a subset of the data, we can print specific variables:

```
proc print;
var VAR1 VAR2 ... ;
```

Many SAS users believe that it is good practice to specify the desired data set. In this manner, we guarantee that we print the data set we want. The modified command is

```
proc print data=NAME;
```

The following command prints the entire delivery data set:

```
proc print data=delivery;
```

The following commands print only the times from the delivery data set:

```
proc print data=delivery;
var time;
```

The run command submits the code. When submitted, SAS produces two files: the output file and the log file. The output file for the delivery data PROC PRINT command follows:

	The SAS System		
Obs	time	cases	distance
1	16.68	7	560
2	11.50	3	220
3	12.03	3	340
4	14.88	4	80
5	13.75	6	150
6	18.11	7	330
7	8.00	2	110
8	17.83	7	210
9	79.24	30	1460
10	21.50	5	605
11	40.33	16	688
12	21.00	10	215
13	13.50	4	255
14	19.75	6	462
15	24.00	9	448
16	29.00	10	776
17	15.35	6	200
18	19.00	7	132
19	9.50	3	36
20	35.10	17	770
21	17.90	10	140
22	52.32	26	810
23	18.75	9	450
24	19.83	8	635
25	10.75	4	150

The resulting log file follows:

NOTE: Copyright (c) 2002–2003 by SAS Institute Inc., Cary, NC, USA.

NOTE: SAS (r) 9.1 (TS1M2)

```

Licensed to VA POLYTECHNIC INST &
STATE UNIV-CAMPUSWIDE-IN, Site 0001798011.
NOTE: This session is executing on the WIN_PRO platform
NOTE: SAS initialization used:
      real time      19.30 seconds
      cpu time       1.56 seconds
1     data delivery;
2     input time cases distance;
3     cards;
NOTE: The data set WORK.DELIVERY has 25 observations and 3
      variables.
NOTE: DATA statement used (Total process time):
      real time      1.22 seconds
      CPU time       0.23 seconds
29    proc print data-delivery;
30    run;
NOTE: There were 25 observations read from the data set
      WORK.DELIVERY.
NOTE: PROCEDURE PRINT used (Total process time):
      real time      0.55 seconds
      cpu time       0.17 seconds

```

The log file provides a brief summary of the SAS session. It tells the analyst how many observations are in the data set, how many observations have missing data (in this case, there are no missing data), the commands executed, and any errors. The log file is almost essential for debugging SAS code. Section D.5 provides more details about this file.

B. Entering Data from a Text File

We can use the infile statement to read data from a text file. The form of this statement is

```
infile 'FULL FILE NAME';
```

The infile statement requires the full file name, including all path information (all the directories). The full file name must be enclosed by single quotes. Of course, the statement must end in a semicolon (;). The following example has the data in a text file named `delivery.txt` that is located in the directory

```
C:\My Stuff\Disk-Books\Regression 5th Ed
```

of my Windows laptop. UNIX follows a slightly different path convention. The following example illustrates how to use the infile statement for the delivery data:

```
data delivery;
  infile 'C:\My Stuff\Disk-Books\Regression 5th Ed\
delivery.txt';
  input time cases distance;
run;
```

D.2 CREATING PERMANENT SAS DATA SETS

There are many occasions where we expect to use a single data set many times. For example, many regression courses require projects that involve analyzing a single data set several times over the semester as the students learn more analytical techniques. In such a situation, it is nice to read the data only once and then create a permanent data set that is available for future use.

Step 1: Specify the Directory for the Permanent Data Set We specify the directory for our permanent data set through the libname statement, which has the form

```
libname NAME1 'FULL DIRECTORY NAME';
```

NAME-1 is the name for the directory that we use purely within the SAS code. FULL DIRECTORY NAME is the actual name of the directory, including the full path information.

Step 2: Use the Data Statement to Create the Data Set The key point is to use the appropriate permanent name for the data set in the data statement. Specifically, suppose that we wish to create a data set named setname and that we named the directory name1. The appropriate name for the permanent SAS data set is name1.setname. The following example creates a SAS data set named book.delivery in the directory; C:\ My Stuff \ Disk-Books \ Regression 5th Ed.

```
libname book 'c:\My Stuff\Disk-Books\Regression 5th Ed';
data book.delivery;
  infile 'C:\My Stuff\Disk-Books\Regression 5th Ed\
delivery.txt';
  input time cases distance;
run;
```

The following code illustrates how to use the permanent data set. The libname statement must appear somewhere in the SAS code prior to the data set's use by a procedure:

```
libname book 'c:\My Stuff\Disk-Books\Regression 5th Ed';
proc reg data=book.delivery;
  model time=cases distance;
run;
```

The output from this code follows:

```

                The REG Procedure
                Model: MODEL1
                Dependent Variable: time

Number of Observations Read      25
Number of Observations Used      25

                Analysis of Variance

Source                DF      Sum of      Mean
                   Squares      Square      F Value      Pr > F
Model                 2    5550.81092    2775.40546    261.24      <.0001
Error                 22     233.73168     10.62417
Corrected Total       24    5784.54260

Root MSE                3.25947      R- square      0.9596
Dependent Mean          22.38400      Adj R- Sq      0.9559
Coeff Var                14.56162

                Parameter Estimates

Variable                DF      Parameter      Standard
                   Estimate      Error      t Value      Pr > |t|
Intercept               1         2.34123         1.09673         2.13         0.0442
cases                   1         1.61591         0.17073         9.46         <.0001
distance                 1         0.01438         0.00361         3.98         0.0006

```

D.3 IMPORTING DATA FROM AN EXCEL FILE

The PC version of SAS has a nice wizard for importing an EXCEL spreadsheet as a SAS data set. The user has the option to bring the data in as a permanent data set or a temporary data set. A temporary data set exists purely for the duration of the SAS session. To bring the EXCEL spreadsheet as a permanent data set, we need to run an appropriate libname statement prior to using the wizard.

The first row of the EXCEL spreadsheet needs to provide the variable names associated with each column. The names provided in the first row will become the variables in the SAS data set.

It is not as easy to import an EXCEL spreadsheet into the UNIX version of SAS. The steps required follow.

Step 1: Export the EXCEL Spreadsheet We will need the EXCEL spreadsheet in dbf format (DBF III, IV, or V), which is easily done by the Save As button in EXCEL.

Step 2: Get the dbf File into UNIX Format If the dbf file was created on a Windows computer, we need to change its format for UNIX. Save the file in a UNIX directory and then execute the following UNIX command:

```
dos2unix-ascii data>newdata
```

Step 3: Import the File into SAS Let NAME.dbf be the name of the dbf file. The following command creates a temporary work file named NAME:

```
proc import dbms=dbf out=work.NAME datafile="NAME.dbf";
```

Step 4: When in Doubt, Contact Your System's Administrator! Things often seem to go wrong when crossing platforms, such as from Windows to UNIX. What works for one set of systems may not work perfectly for another.

D.4 OUTPUT COMMAND

The output command allows the user to append a previously created data set with information generated by a SAS procedure. Many SAS procedures support the output command. Its general form is

```
output out=SAS-NAME (output list) ;
```

In this case SAS-NAME is the name of the data set created by the output command. The resulting data set is the data set used by the procedure plus the variables added through (output list). Suppose we wish to add the predicted values and the raw residuals to the delivery time data set. Let delivery2 be the new data set. Suppose that we call the predicted delivery times ptime and that we call the raw residuals res. The appropriate output command is

```
output out=delivery2 p=ptime r=res;
```

The p is SAS's designation for the predicted values generated by PROC REG, and r is the designation for the raw residuals. In the output list, the SAS designation always is on the left-hand side of the = sign. The variable name within the new data set is always on the right-hand side. To create a data set with

It is very important to remember that the default data set used by a SAS procedure is the one most recently created. One of the saving graces of the output command is that it includes the data set used by the procedure to create the output data set.

D.5 LOG FILE

Every SAS session generates a "log" file that provides a brief summary. New SAS users find out very quickly (and very painfully) that SAS source code is a computer program that must be compiled. As such, the code must follow certain syntax rules. It is important to note that SAS can produce an incorrect, even nonsensical, analysis even if SAS does not reject the syntax. The log file is almost essential for debugging SAS code.

The log file provides a brief summary of the SAS session. It tells the analyst how many observations are in the data set, how many observations have missing data

(in this case, there are no missing data), the commands executed, and any errors. Below is a simple example from a correct analysis:

NOTE: Copyright (c) 2002-2003 by SAS Institute Inc., Cary, NC, USA

NOTE: SAS (r) 9.1 (TSIM2)
Licensed to VA POLYTECHNIC INST & STATE UNIV-CAMPUSWIDE-IN, Site 0001798011.

NOTE: This session is executing on the WIN_PRO platform.

NOTE: SAS initialization used:
real time 19.30 seconds
cpu time 1.56 seconds

```
1 data delivery; 2 input time cases distance;
3 cards;
```

NOTE: The data set WORK.DELIVERY has 25 observations and 3 variables.

NOTE: DATA statement used (Total process time):
real time 1.22 seconds
cpu time 0.23 seconds

```
29 proc print data=delivery; 30 run;
```

NOTE: There were 25 observations read from the data set WORK.DELIVERY

NOTE: PROCEDURE PRINT used (Total process time):
real time 0.55 seconds
cpu time 0.17 seconds

Below is an example where we give the command

```
print data=deli very
```

instead of the proper syntax

```
proc print data=delivery;
```

NOTE: Copyright (c) 2002-2003 by SAS Institute Inc., Cary, NC, USA.

NOTE: SAS (r) 9.1 (TS1M2)
Licensed to VA POLYTECHNIC INST & STATE UNIV-CAMPUSWIDE-IN, Site 0001798011.

NOTE: This session is executing on the WIN_PRO platform.

NOTE: SAS initialization used:
real time 5.03 seconds
cpu time 1.73 seconds

```

1      libname book 'c:\My Stuff\Disk-Books\Regression 5th
      Ed ' ;
NOTE: Libref BOOK was successfully assigned as follows:
      Engine 2q V9
      Physical Name: c:\My Stuff\Disk-Books\Regression 5th
      Ed
2      print data=book.delivery;
      --
      180
      ERROR 180- 322: Statement is not valid or it is
used out of
proper order.
3      run;

```

One of the most frustrating errors in SAS occurs when we forget a semicolon. SAS rarely, if ever, flags a missing semicolon directly as an error! It flags a syntax problem later in the source code that is the consequence of the missing semicolon.

Finally, for large sets it is not practical to print the entire data set. Many people use SAS to create massive data sets through “merges,” among other techniques. In these circumstances, the log file gives the first information, usually through the number of observations in the data set, of problems. As such, the log file is essential to good SAS programming.

D.6 ADDING VARIABLES TO AN EXISTING SAS DATA SET

We can add variables to a previously created SAS data set. For example, suppose that we would like to use $\text{cases2} = \text{cases}^2$ as a regressor for the delivery data, and suppose that the delivery data are in a SAS data set named delivery. We shall call the new data set delivery2. The appropriate SAS commands are

```

data delivery2;
  set delivery;
  cases2=cases*cases;
run;

```

Suppose we wish to create a new permanent SAS data set where we add cases2 to the permanent SAS data set book.delivery. Suppose further that our code already includes the appropriate libname statement. The appropriate SAS commands are

```

data book.delivery2;
  set book.delivery;
  cases2=cases*cases;
run;

```

APPENDIX E

INTRODUCTION TO R TO PERFORM LINEAR REGRESSION ANALYSIS

R is a popular statistical software package, primarily because it is freely available at www.r-project.org. As a result, many instructors as well as many of the more sophisticated statistical practitioners are switching to it. We have found that using R makes sense with graduate students who are already familiar with statistical methodology, especially those students with some experience using more sophisticated statistical software packages such as SAS. We personally recommend using less sophisticated and fully supported statistical software packages such as Minitab and SAS-JMP for undergraduates and those new to formal statistical analysis. However, we realize that some instructors prefer to use R even for these less sophisticated students. As a result, we created this appendix to introduce some of the basics of R.

E.1 BASIC BACKGROUND ON R

According to the project's webpage:

The R Foundation is a not-for-profit organization working in the public interest. It has been founded by the members of the R Development Core Team in order to

- Provide support for the R project and other innovations in statistical computing. We believe that R has become a mature and valuable tool and we would like to ensure its continued development and the development of future innovations in software for statistical and computational research.

Introduction to Linear Regression Analysis, Fifth Edition. Douglas C. Montgomery, Elizabeth A. Peck, G. Geoffrey Vining.

© 2012 John Wiley & Sons, Inc. Published 2012 by John Wiley & Sons, Inc.

- Provide a reference point for individuals, institutions or commercial enterprises that want to support or interact with the R development community.
- Hold and administer the copyright of R software and documentation.

R is an official part of the Free Software Foundation's GNU project, and the R Foundation has similar goals to other open source software foundations like the Apache Foundation or the GNOME Foundation.

Among the goals of the R Foundation are the support of continued development of R, the exploration of new methodology, teaching and training of statistical computing and the organization of meetings and conferences with a statistical computing orientation. We hope to attract sufficient funding to make these goals realities.

R is a very sophisticated statistical software environment, even though it is freely available. The contributors include many of the top researchers in statistical computing. In many ways, it reflects the very latest statistical methodologies. On the other hand, the contributors truly form a community that is quite fluid. It can take quite a bit of work to keep current with the latest features of R. The help documentation with the basic releases is really of limited value. Of course, in many ways, you get what you pay for!

R itself is a high-level programming language. Most of its commands are pre-written functions. It does have the ability to run loops and call other routines, for example, in C. Since it is primarily a programming language, it often presents challenges to novice users.

E.2 BASIC DATA ENTRY

The best way to understand R is through examples. We present here some of the R code illustrated through the text. We can illustrate many of the basic features of basic data entry and data manipulation with the vapor pressure data set in Exercise 5.2. The data are:

Temp	vp
273	4.6
283	9.2
293	17.5
303	31.8
313	55.3
323	92.5
333	149.4
343	233.7
353	355.1
363	525.8
373	760.0

The brute force way to enter the data uses the `c()` function:

```
temp <- c(273, 283, 293, 303, 313, 323, 333, 343, 353,
363, 373)
vp <- c(4.6, 9.2, 17.5, 31.8, 55.3, 92.5, 149.4, 233.7,
355.1, 525.8, 760.0)
```

To check your data entry, you can use the `print()` function. In our case,

```
print(temp)
print(vp)
```

The resulting output is:

```
> print(temp)
 [1] 273 283 293 303 313 323 333 343 353 363 373
> print(vp)
 [1] 4.6 9.2 17.5 31.8 55.3 92.5 149.4 233.7 355.1
525.8 760.0
```

For small data sets, the brute force approach works well. For larger data sets, we recommend using the `read.table()` function. You can create a text file with the data in columns. Generally, the first row is a “header” giving the variable names. The `read.table()` function works well for this type of file. Let `vapor.txt` be such a file for the vapor pressure data. The first step is to change the working directory for R to the directory that contains the data file. You can do this under the File box. The following command reads the data file and places the data into the object `vapor`.

```
vapor <- read.table("vapor.txt", header=TRUE, sep=" ")
```

To check the contents of `vapor`, we can use the `print()` function. The resulting output is:

```
> print(vapor)
      temp      vp
1      273      4.6
2      283      9.2
3      293     17.5
4      303     31.8
5      313     55.3
6      323     92.5
7      333    149.4
8      343    233.7
9      353    355.1
10     363    525.8
11     373    760.0
```

If we read the data from a file, then we cannot refer to the temperatures as `temp` even though `temp` was the name of the column in the original data file; rather, we must also specify the object that contains it. The following command prints the `temp` column of the `vapor` object.

```
> print(vapor$temp)
[1] 273 283 293 303 313 323 333 343 353 363 373
```

Basic physical chemistry suggests modeling the natural log of the vapor pressure as a linear function of the inverse of the temperature. The following commands create the inverse of the temperatures and then prints them.

```
> inv_temp <- 1/vapor$temp
> print(inv_temp)
[1] 0.003663004 0.003533569 0.003412969 0.003300330
0.003194888 0.003095975
[7] 0.003003003 0.002915452 0.002832861 0.002754821
0.002680965
```

The `log()` function generates the natural log. The following commands create the natural log of the vapor pressures and then prints them.

```
> log_vp <- log(vapor$vp)
> print(log_vp)
[1] 1.526056 2.219203 2.862201 3.459466 4.012773 4.527209
5.006627 5.454038
[9] 5.872399 6.264921 6.633318
```

Another useful command for regression analysis is the `sqrt()` function, which works exactly like the `log()` function.

`R` does generate plots, but it takes a great deal of work to make good looking plots. The basic plot function is `plot(y,x)` where `y` is the object on the y-axis and `x` is the object on the x-axis. The following command generates the scatter plot for the vapor pressure data.

```
> plot(vapor$vp, vapor$temp)
```

The `write.table()` function generates an output data file that is useful for using other plotting software. The following code appends the inverse temperatures and the natural logs of the vapor pressures to the original data to form a new object `vapor2` and then creates the output data file `vapor_output.txt`.

```
> vapor2 <- cbind(vapor, inv_temp, log_vp)
> write.table(vapor2, "vapor_output.txt")
```

E.3 BRIEF COMMENTS ON OTHER FUNCTIONALITY IN R

`R` does a very nice job manipulating matrices. This textbook, however, uses statistical software to perform the matrix calculations “under the hood,” so to speak. The text

does show the matrix formulations of the procedures we discuss. However, we do not expect students to perform these calculations directly. As a result, we consider an introduction to the matrix manipulations within R beyond our scope. As appropriate, the text does give the basic R code to perform analyses. We leave it to the course instructor to present the details of the matrix manipulations within R.

E.4 R COMMANDER

R Commander is an add-on package to R. It also is freely available. It provides an easy-to-use user interface, much like Minitab and JMP, to the parent R product. R Commander makes it much more convenient to use R; however, it does not provide much flexibility in its analysis. For example, R Commander does not allow the user to use the externally studentized residual for the residual plots. R Commander is a good way for users to get familiar with R. Ultimately, however, we recommend the use of the parent R product.

REFERENCES

- Adichie, J. N. [1967], "Estimates of regression parameters based on rank tests," *Ann. Math. Stat.*, **38**, 894–904.
- Aitkin, M. A. [1974], "Simultaneous inference and the choice of variable subsets," *Technometrics* **16**, 221–227.
- Akaike, H. [1973], "Information theory and an extension of the maximum likelihood principle," in B. N. Petrov and F. Csaki (editors), *Second International Symposium on Information Theory*. Budapest: Akademiai Kiado.
- Allen, D. M. [1971], "Mean square error of prediction as a criterion for selecting variables," *Technometrics*, **13**, 469–475.
- Allen, D. M. [1974], "The relationship between variable selection and data augmentation and a method for prediction," *Technometrics*, **16**, 125–127.
- Andrews, D. F. [1971], "Significance tests based on residuals," *Biometrika*, **58**, 139–148.
- Andrews, D. F. [1974], "A robust method for multiple linear regression," *Technometrics*, **16**, 523–531.
- Andrews, D. F. [1979], "The robustness of residual displays," in R. L. Launer and G. N. Wilkinson (Eds.), *Robustness in Statistics*, Academic Press, New York, pp. 19–32.
- Andrews, D. F., P. J. Bickel, F. R. Hampel, P. J. Huber, W. H. Rogers, and J. W. Tukey [1972], *Robust Estimates of Location*, Princeton University Press, Princeton, N.J.
- Anscombe, F. J. [1961], "Examination of residuals," in *Proceedings of the Fourth Berkeley Symposium on Mathematical Statistics and Probability*, Vol. 1, University of California, Berkeley, pp. 1–36.
- Anscombe, F. J. [1967], "Topics in the investigation of linear relations fitted by the method of least squares," *J. R. Stat. Soc. Ser. B*, **29**, 1–52.
- Anscombe, F. J. [1973], "Graphs in statistical analysis," *Am. Stat.*, **27**(1), 17–21.

- Anscombe, F. J. and J. W. Tukey [1963], "The examination and analysis of residuals," *Technometrics*, **5**, 141–160.
- Askin, R. G. and D. C. Montgomery [1980], "Augmented robust estimators," *Technometrics*, **22**, 333–341.
- Askin, R. G. and D. C. Montgomery [1984], "An analysis of constrained robust regression estimators," *Nav. Res. Logistics Q.*, **31**, 283–296.
- Atkinson, A. C. [1983], "Diagnostic regression for shifted power transformations," *Technometrics*, **25**, 23–33.
- Atkinson, A. C. [1985], *Plots, Transformations, and Regression*, Clarendon Press, Oxford.
- Atkinson, A. C. [1994], "Fast very robust methods for the detection of multiple outliers," *J. Am. Stat. Assoc.*, **89**, 1329–1339.
- Bailer, A. J. and Piegorsch, W. W. [2000], "From quanal counts to mechanisms and systems: The past present, and future of biometrics in environmental toxicology," *Biometrics*, **56**, 327–336.
- Barnett, V. and T. Lewis [1994], *Outliers in Statistical Data*, 3rd ed., Wiley, New York.
- Bates, D. M. and D. G. Watts [1988], *Nonlinear Regression Analysis and Its Applications*, Wiley, New York.
- Beaton, A. E. [1964], *The Use of Special Matrix Operators in Statistical Calculus*, Research Bulletin RB-64-51, Educational Testing Service, Princeton, N.J.
- Beaton, A. E. and J. W. Tukey [1974], "The fitting of power series, meaning polynomials, illustrated on band spectroscopic data," *Technometrics*, **16**, 147–185.
- Belsley, D. A., E. Kuh, and R. E. Welsch [1980], *Regression Diagnostics: Identifying Influential Data and Sources of Collinearity*, Wiley, New York.
- Bendel, R. B. and A. A. Afifi [1974], "Comparison of stopping rules in forward stepwise regressions," presented at the Joint Statistical Meeting, St. Louis, Mo.
- Berk, K. N. [1978], "Comparing subset regression procedures," *Technometrics*, **20**, 1–6.
- Berkson, J. [1950], "Are there two regressions?" *J. Am. Stat. Assoc.*, **45**, 164–180.
- Berkson, J. [1969], "Estimation of a linear function for a calibration line; consideration of a recent proposal," *Technometrics*, **11**, 649–660.
- Bishop, C. M. [1995], *Neural Networks for Pattern Recognition*, Clarendon Press, Oxford.
- Bloomfield, P. and W. L. Steiger [1983], *Least Absolute Deviations: Theory, Applications, and Algorithms*, Birkhuser Verlag, Boston.
- Book, D., J. Booker, H. O. Hartley, and R. I. Sielken, Jr. [1980], "Unbiased L1 estimators and their covariances," ONR THEMIS Technical Report No. 64, Institute of Statistics, Texas A & M University.
- Box, G. E. P. [1966], "Use and abuse of regression," *Technometrics*, **8**, 625–629.
- Box, G. E. P. and D. W. Behnken [1960], "Some new three level designs for the study of quantitative variables," *Technometrics*, **2**, 455–475.
- Box, G. E. P. and D. R. Cox [1964], "An analysis of transformations," *J. R. Stat. Soc. Ser. B*, **26**, 211–243.
- Box, G. E. P. and N. R. Draper [1959], "A basis for the selection of a response surface design," *J. Am. Stat. Assoc.*, **54**, 622–654.
- Box, G. E. P. and N. R. Draper [1963], "The choice of a second-order rotatable design," *Biometrika*, **50**, 335–352.
- Box, G. E. P. and N. R. Draper [1987], *Empirical Model Building and Response Surfaces*, Wiley, New York.
- Box, G. E. P. and J. S. Hunter [1957], "Multifactor experimental designs for exploring response surfaces," *Ann. Math. Stat.*, **28**, 195–242.

- Box, G. E. P., W. G. Hunter, and J. S. Hunter [1978], *Statistics for Experimenters*, Wiley, New York.
- Box, G. E. P., G. M. Jenkins, and G. C. Reinsel [1994], *Time Series Analysis, Forecasting, and Control*, 3rd ed., Prentice-Hall, Englewood Cliffs, N.J.
- Box, G. E. P. and P. W. Tidwell [1962], "Transformation of the independent variables," *Technometrics*, **4**, 531–550.
- Box, G. E. P. and J. M. Wetz [1973], "Criterion for judging the adequacy of estimation by an approximating response polynomial," Technical Report No. 9, Department of Statistics, University of Wisconsin, Madison.
- Bradley, R. A. and S. S. Srivastava [1979], "Correlation and polynomial regression," *Am. Stat.*, **33**, 11–14.
- Breiman, L., J. H. Friedman, R. A. Olshen, and C. J. Stone [1984], *Classification and Regression Trees*, Wadsworth, Belmont, Calif.
- Brown, P. J. [1977], "Centering and scaling in ridge regression," *Technometrics*, **19**, 35–36.
- Brown, R. L., J. Durbin, and J. M. Evans [1975], "Techniques for testing the constancy of regression relationships over time (with discussion)," *J. R. Stat. Soc. Ser. B*, **37**, 149–192.
- Buse, A. and L. Lim [1977], "Cubic splines as a special case of restricted least squares," *J. Am. Stat. Assoc.*, **72**, 64–68.
- Cady, F. B. and D. M. Allen [1972], "Combining experiments to predict future yield data," *Agron. J.*, **64**, 211–214.
- Carroll, R. J. and D. Ruppert [1985], "Transformation in regression: A robust analysis," *Technometrics*, **27**, 1–12.
- Carroll, R. J. and D. Ruppert [1988], *Transformation and Weighting in Regression*, Chapman & Hall, London.
- Chapman, R. E. [1997–98], "Degradation study of a photographic developer to determine shelf life," *Quality Engineering*, **10**, 137–140.
- Chatterjee, S. and B. Price [1977], *Regression Analysis by Example*, Wiley, New York.
- Coakley, C. W. and T. P. Hettmansperger [1993], "A bounded influence, high breakdown, efficient regression estimator," *J. Am. Stat. Assoc.*, **88**, 872–880.
- Cochrane, D. and G. H. Orcutt [1949], "Application of least squares regression to relationships containing autocorrelated error terms," *J. Am. Stat. Assoc.*, **44**, 32–61.
- Conniffe, D. and J. Stone [1973], "A critical view of ridge regression," *The Statistician*, **22**, 181–187.
- Conniffe, D. and J. Stone [1975], "A reply to Smith and Goldstein," *The Statistician*, **24**, 67–68.
- Cook, R. D. [1977], "Detection of influential observation in linear regression," *Technometrics*, **19**, 15–18.
- Cook, R. D. [1979], "Influential observations in linear regression," *J. Am. Stat. Assoc.*, **74**, 169–174.
- Cook, R. D. [1993], "Exploring partial residual plots," *Technometrics*, **35**, 351–362.
- Cook, R. D. and P. Prescott [1981], "On the accuracy of Bonferroni significance levels for detecting outliers in linear models," *Technometrics*, **22**, 59–63.
- Cook, R. D. and S. Weisberg [1983], "Diagnostics for heteroscedasticity in regression," *Biometrika*, **70**, 1–10.
- Cook, R. D. and S. Weisberg [1994], *An Introduction to Regression Graphics*, Wiley, New York.
- Cox, D. R. and E. J. Snell [1974], "The choice of variables in observational studies," *Appl. Stat.*, **23**, 51–59.
- Curry, H. B. and I. J. Schoenberg [1966], "On Polya frequency functions IV: The fundamental spline functions and their limits," *J. Anal. Math.*, **17**, 71–107.

- Daniel, C. [1976], *Applications of Statistics to Industrial Experimentation*, Wiley, New York.
- Daniel, C. and F. S. Wood [1980], *Fitting Equations to Data*, 2nd ed., Wiley, New York.
- Davies, R. B. and B. Hutton [1975], "The effects of errors in the independent variables in linear regression," *Biometrika*, **62**, 383–391.
- Davison, A. C. and D. V. Hinkley [1997], *Bootstrap Methods and Their Application*, Cambridge University Press, London.
- De Jong, P. J., T. De Wet, and A. H. Welsh [1988], "Mallows-type bounded-influence-regression trimmed means," *J. Am. Stat. Assoc.*, **83**, 805–810.
- DeLury, D. B. [1960], *Values and Integrals of the Orthogonal Polynomials up to $N = 26$* , University of Toronto Press, Toronto.
- Dempster, A. P., M. Schatzoff, and N. Wermuth [1977], "A simulation study of alternatives to ordinary least squares," *J. Am. Stat. Assoc.*, **72**, 77–90.
- Denby, L. and W. A. Larson [1977], "Robust regression estimators compared via Monte Carlo," *Commun. Stat.*, **A6**, 335–362.
- Dodge, Y. [1987], *Statistical Data Analysis Based on the L_1 -Norm and Related Methods*, North-Holland, Amsterdam.
- Dolby, G. R. [1976], "The ultrastructural relation: A synthesis of the functional and structural relations," *Biometrika*, **63**, 39–50.
- Dolby, J. L. [1963], "A quick method for choosing a transformation," *Technometrics*, **5**, 317–325.
- Draper, N. R., J. Guttman, and H. Kanemasa [1971], "The distribution of certain regression statistics," *Biometrika*, **58**, 295–298.
- Draper, N. R. and H. Smith [1998], *Applied Regression Analysis*, 3rd ed., Wiley, New York.
- Draper, N. R. and R. C. Van Nostrand [1977a], "Shrinkage estimators: Review and comments," Technical Report No. 500, Department of Statistics, University of Wisconsin, Madison.
- Draper, N. R. and R. C. Van Nostrand [1977b], "Ridge regression: Is it worthwhile?" Technical Report No. 501, Department of Statistics, University of Wisconsin, Madison.
- Draper, N. R. and R. C. Van Nostrand [1979], "Ridge regression and James–Stein estimators: Review and comments," *Technometrics*, **21**, 451–466.
- Durbin, J. [1970], "Testing for serial correlation in least squares regression when some of the regressors are lagged dependent variables," *Econometrica*, **38**, 410–421.
- Durbin, J. and G. S. Watson [1950], "Testing for serial correlation in least squares regression I," *Biometrika*, **37**, 409–438.
- Durbin, J. and G. S. Watson [1951], "Testing for serial correlation in least squares regression II," *Biometrika*, **38**, 159–178.
- Durbin, J. and G. S. Watson [1971], "Testing for serial correlation in least squares regression III," *Biometrika*, **58**, 1–19.
- Dutter, R. [1977], "Numerical solution of robust regression problems: Computational aspects, a comparison," *J. Stat. Comput. Simul.*, **5**, 207–238.
- Dutter, R. and P. J. Hober [1981], "Numerical methods for the robust nonlinear regression problem," *J. Stat. Comput. Simul.*, **13**, 79–114.
- Dykstra, O., Jr. [1971], "The augmentation of experimental data to maximize $(\mathbf{X}'\mathbf{X})$," *Technometrics*, **13**, 682–688.
- Edwards, J. B. [1969], "The relation between the F -test and R^2 ," *Am. Stat.*, **23**, 28.
- Efron, B. [1979], "Bootstrap methods: Another look at the jackknife," *Ann. Stat.*, **7**, 1–26.
- Efron, B. [1982], *The Jackknife, the Bootstrap and Other Resampling Plans*, Society for Industrial and Applied Mathematics, Philadelphia.

- Efron, B. [1987], "Better bootstrap confidence intervals (with discussion)," *J. Am. Stat. Assoc.*, **82**, 172–200.
- Efron, B. and R. Tibshirani [1986], "Bootstrap methods for standard errors, confidence intervals, and other measures of statistical accuracy," *Stat. Sci.*, **1**, 54–77.
- Efron, B. and R. Tibshirani [1993], *An Introduction to the Bootstrap*, Chapman & Hall, London.
- Efroymson, M. A. [1960], "Multiple regression analysis," in A. Ralston and H. S. Wilf (Eds.), *Mathematical Methods for Digital Computers*, Wiley, New York.
- Ellerton, R. R. W. [1978], "Is the regression equation adequate—A generalization," *Technometrics*, **20**, 313–316.
- Eubank, R. L. [1988], *Spline Smoothing and Nonparametric Regression*, Dekker, New York.
- Eubank, R. L. and P. Speckman [1990], "Curve fitting by polynomial-trigonometric regression," *Biometrika*, **77**, 1–9.
- Everitt, B. S. [1993], *Cluster Analysis*, 3rd ed., Halsted Press, New York.
- Farrar, D. E. and R. R. Glauber [1967], "Multicollinearity in regression analysis: The problem revisited," *Rev. Econ. Stat.*, **49**, 92–107.
- Feder, P. I. [1974], "Graphical techniques in statistical data analysis—Tools for extracting information from data," *Technometrics*, **16**, 287–299.
- Forsythe, A. B. [1972], "Robust estimation of straight-line regression coefficients by minimizing p th power deviations," *Technometrics*, **14**, 159–166.
- Forsythe, G. E. [1957], "Generation and use of orthogonal polynomials for data-fitting with a digital computer," *J. Soc. Ind. Appl. Math.*, **5**, 74–87.
- Fuller, W. A. [1976], *Introduction to Statistical Time Series*, Wiley, New York.
- Furnival, G. M. [1971], "All possible regressions with less computation," *Technometrics*, **13**, 403–408.
- Furnival, G. M. and R. W. M. Wilson, Jr. [1974], "Regression by leaps and bounds," *Technometrics*, **16**, 499–511.
- Gallant, A. R. and W. A. Fuller [1973], "Fitting segmented polynomial regression models whose join points have to be estimated," *J. Am. Stat. Assoc.*, **63**, 144–147.
- Garside, M. J. [1965], "The best subset in multiple regression analysis," *Appl. Stat.*, **14**, 196–200.
- Gartside, P. S. [1972], "A study of methods for comparing several variances," *J. Am. Stat. Assoc.*, **67**, 342–346.
- Gaylor, D. W. and J. A. Merrill [1968], "Augmenting existing data in multiple regression," *Technometrics*, **10**, 73–81.
- Geisser, S. [1975], "The predictive sample reuse method with applications," *J. Am. Stat. Assoc.*, **70**, 320–328.
- Gentle, J. M., W. J. Kennedy, and V. A. Sposito [1977], "On least absolute deviations estimators," *Commun. Stat.*, **A6**, 839–845.
- Gibbons, D. G. [1979], *A Simulation Study of Some Ridge Estimators*, General Motors Research Laboratories, Mathematics Department, GMR-2659 (rev. ed.), Warren, Mich.
- Gnanadesikan, R. [1977], *Methods for Statistical Analysis of Multivariate Data*, Wiley, New York.
- Goldberger, A. S. [1964], *Econometric Theory*, Wiley, New York.
- Goldstein, M. and A. F. M. Smith [1974], "Ridge-type estimators for regression analysis," *J. R. Stat. Soc. Ser. B*, **36**, 284–291.
- Golub, G. H. [1969], "Matrix decompositions and statistical calculations," in R. C. Milton and J. A. Welder (Eds.), *Statistical Computation*, Academic, New York.

- Gorman, J. W. and R. J. Toman [1966], "Selection of variables for fitting equations to data." *Technometrics*, **8**, 27–51.
- Graybill, F. A. [1961], *An Introduction to Linear Statistical Models*, Vol. 1, McGraw-Hill, New York.
- Graybill, F. A. [1976], *Theory and Application of the Linear Model*, Duxbury, North Scituate, Mass.
- Guilkey, D. K. and J. L. Murphy [1975], "Directed ridge regression techniques in cases of multicollinearity," *J. Am. Stat. Assoc.*, **70**, 769–775.
- Gupta, A. and A. K. Das [2000], "Improving resistivity of UF resin through setting of process parameters," *Quality Engineering*, **12**, 611–618.
- Gunst, R. F. [1979], "Similarities among least squares, principal component, and latent root regression estimators," presented at the Washington, D.C., Joint Statistical Meetings.
- Gunst, R. F. and R. L. Mason [1977], "Biased estimation in regression: An evaluation using mean squared error," *J. Am. Stat. Assoc.*, **72**, 616–628.
- Gunst, R. F. and R. L. Mason [1979], "Some considerations in the evaluation of alternative prediction equations," *Technometrics*, **21**, 55–63.
- Gunst, R. F., J. T. Webster, and R. L. Mason [1976], "A comparison of least squares and latent root regression estimators," *Technometrics*, **18**, 75–83.
- Gunter, B. [1997a], "Tree-based classification and regression. Part I: Background and fundamentals," *Qual. Prog.*, **28**, August, 159–163.
- Gunter, B. [1997b], "Tree-based classification and regression. Part II: Assessing classification performance," *Qual. Prog.*, **28**, December, 83–84.
- Gunter, B. [1998], "Tree-based classification and regression. Part III: Tree-based procedures," *Qual. Prog.*, **31**, February, 121.
- Hadi, A. S. and J. S. Simonoff [1993], "Procedures for the identification of multiple outliers in linear models," *J. Am. Stat. Assoc.*, **88**, 1264–1272.
- Hahn, G. J. [1972], "Simultaneous prediction intervals for a regression model," *Technometrics*, **14**, 203–214.
- Hahn, G. J. [1973], "The coefficient of determination exposed!" *Chem. Technol.*, **3**, 609–614.
- Hahn, G. J. [1979], "Fitting regression models with no intercept term," *J. Qual. Technol.*, **9**(2), 56–61.
- Hahn, G. J. and R. W. Hendrickson [1971], "A table of percentage points of the largest absolute value of k student t variates and its applications," *Biometrika*, **58**, 323–332.
- Haitovski, Y. [1969], "A note on the maximization of R^2 ," *Am. Stat.*, **23**(1), 20–21.
- Hald, A. [1952], *Statistical Theory with Engineering Applications*, Wiley, New York.
- Halperin, M. [1961], "Fitting of straight lines and prediction when both variables are subject to error," *J. Am. Stat. Assoc.*, **56**, 657–669.
- Halperin, M. [1970], "On inverse estimation in linear regression," *Technometrics*, **12**, 727–736.
- Hawkins, D. M. [1973], "On the investigation of alternative regressions by principal components analysis," *Appl. Stat.*, **22**, 275–286.
- Hawkins, D. M. [1994], "The feasible solution algorithm for least trimmed squares regression," *Comput. Stat. Data Anal.*, **17**, 185–196.
- Hawkins, D. M., D. Bradu, and G. V. Kass [1984], "Location of several outliers in multiple regression using elemental sets," *Technometrics*, **26**, 197–208.
- Hayes, J. G. (Ed.) [1970], *Numerical Approximations to Functions and Data*, Athlone Press, London.
- Hayes, J. G. [1974], "Numerical methods for curve and surface fitting," *J. Inst. Math. Appl.*, **10**, 144–152.

- Haykin, S. [1994], *Neural Networks: A Comprehensive Foundation*, Macmillan Co., New York.
- Hemmerle, W. J. and T. F. Brantle [1978], "Explicit and constrained generalized ridge regression," *Technometrics*, **20**, 109–120.
- Hettmansperger, T. P. and J. W. Mckean [1998], *Robust Nonparametric Statistical Methods*, Vol. 5 of Kendall's Library of Statistics, Arnold, London.
- Hill, R. C., G. G. Judge, and T. B. Fomby [1978], "On testing the adequacy of a regression model," *Technometrics*, **20**, 491–494.
- Hill, R. W. [1979], "On estimating the covariance matrix of robust regression M-estimates," *Commun. Stat.*, **A8**, 1183–1196.
- Himmelblau, D. M. [1970], *Process Analysis by Statistical Methods*, Wiley, New York.
- Hoadley, B. [1970], "A Bayesian look at inverse linear regression," *J. Am. Stat. Assoc.*, **65**, 356–369.
- Hoaglin, D. C. and R. E. Welsch [1978], "The hat matrix in regression and ANOVA," *Am. Stat.*, **32**(1), 17–22.
- Hocking, R. R. [1972], "Criteria for selection of a subset regression: Which one should be used," *Technometrics*, **14**, 967–970.
- Hocking, R. R. [1974], "Misspecification in regression," *Am. Stat.*, **28**, 39–40.
- Hocking, R. R. [1976], "The analysis and selection of variables in linear regression," *Biometrics*, **32**, 1–49.
- Hocking, R. R. and L. R. LaMotte [1973], "Using the SELECT program for choosing subset regressions," in W. O. Thompson and F. B. Cady (Eds.), *Proceedings of the University of Kentucky Conference on Regression with a Large Number of Predictor Variables*, Department of Statistics, University of Kentucky, Lexington.
- Hocking, R. R., F. M. Speed, and M. J. Lynn [1976], "A class of biased estimators in linear regression," *Technometrics*, **18**, 425–437.
- Hodges, S. D. and P. G. Moore [1972], "Data uncertainties and least squares regression," *Appl. Stat.*, **21**, 185–195.
- Hoerl, A. E. [1959], "Optimum solution of many variable equations," *Chem. Eng. Prog.*, **55**, 69.
- Hoerl, A. E. and R. W. Kennard [1970a], "Ridge regression: Biased estimation for nonorthogonal problems," *Technometrics*, **12**, 55–67.
- Hoerl, A. E. and R. W. Kennard [1970b], "Ridge regression: Applications to nonorthogonal problems," *Technometrics*, **12**, 69–82.
- Hoerl, A. E. and R. W. Kennard [1976], "Ridge regression: Iterative estimation of the biasing parameter," *Commun. Stat.*, **A5**, 77–88.
- Hoerl, A. E., R. W. Kennard, and K. F. Baldwin [1975], "Ridge regression: Some simulations," *Commun. Stat.*, **4**, 105–123.
- Hogg, R. V. [1974], "Adaptive robust procedures: A partial review and some suggestions for future applications and theory," *J. Am. Stat. Assoc.*, **69**, 909–925.
- Hogg, R. V. [1979a], "Statistical robustness: One view of its use in applications today," *Am. Stat.*, **33**(3), 108–115.
- Hogg, R. V. [1979b], "An introduction to robust estimation," in R. L. Launer and G. N. Wilkinson (Eds.), *Robustness in Statistics*, Academic, New York, pp. 1–18.
- Hogg, R. V. and R. H. Randles [1975], "Adaptive distribution-free regression methods and their applications," *Technometrics*, **17**, 399–407.
- Holland, P. W. and R. E. Welsch [1977], "Robust regression using iteratively reweighted least squares," *Commun. Stat.*, **A6**, 813–828.
- Huber, P. J. [1964], "Robust estimation of a location parameter," *Ann. Math. Stat.*, **35**, 73–101.

- Huber, P. J. [1972], "Robust statistics: A review," *Ann. Math. Stat.*, **43**, 1041–1067.
- Huber, P. J. [1973], "Robust regression: Asymptotics, conjectures, and Monte Carlo," *Ann. Stat.*, **1**, 799–821.
- Huber, P. J. [1981], *Robust Statistics*, Wiley, New York.
- Jaeckel, L. A. [1972], "Estimating regression coefficients by minimizing the dispersion of the residuals," *Ann. Math. Stat.*, **43**, 1449–1458.
- Joglekar, G., J. H. Schuenemeyer, and V. LaRiccia [1989], "Lack-of-fit testing when replicates are not available," *Am. Stat.*, **43**, 135–143.
- Johnson, R. A. and D. W. Wichern [1992], *Applied Multivariate Statistical Analysis*, Prentice-Hall, Englewood Cliffs, N.J.
- Johnston, J. [1972], *Econometric Methods*, McGraw-Hill, New York.
- Jurečková, J. [1977], "Asymptotic relations of M -estimates and R -estimates in linear regression models," *Ann. Stat.*, **5**, 464–472.
- Kalotay, A. J. [1971], "Structural solution to the linear calibration problem," *Technometrics*, **13**, 761–769.
- Kendall, M. G. and G. U. Yule [1950], *An Introduction to the Theory of Statistics*, Charles Griffin, London.
- Kennard, R. W. and L. Stone [1969], "Computer aided design of experiments," *Technometrics*, **11**, 137–148.
- Kennedy, W. J. and T. A. Bancroft [1971], "Model-building for prediction in regression using repeated significance tests," *Ann. Math. Stat.*, **42**, 1273–1284.
- Khuri, A. H. and J. A. Cornell [1996], *Response Surfaces: Designs and Analyses*, 2nd ed., Dekker, New York.
- Kiefer, J. [1959], "Optimum experimental designs," *Journal of the Royal Statistical Society, Series B*, **21**, 272–304.
- Kiefer, J. [1961], "Optimum designs in regression problems. II," *Annals of Mathematical Statistics*, **32**, 298–325.
- Kiefer, J. and J. Wolfowitz [1959], "Optimum designs in regression problems," *Annals of Mathematical Statistics*, **30**, 271–294.
- Krasker, W. S. and R. E. Welsch [1982], "Efficient bounded-influence regression estimation," *J. Am. Stat. Assoc.*, **77**, 595–604.
- Krutchkoff, R. G. [1967], "Classical and inverse regression methods of calibration," *Technometrics*, **9**, 425–439.
- Krutchkoff, R. G. [1969], "Classical and inverse regression methods of calibration in extrapolation," *Technometrics*, **11**, 605–608.
- Kunugi, T., T. Tamura, and T. Naito [1961], "New acetylene process uses hydrogen dilution," *Chem. Eng. Prog.*, **57**, 43–49.
- Land, C. E. [1974], "Confidence interval estimation for means after data transformation to normality," *J. Am. Stat. Assoc.*, **69**, 795–802 (Correction, *ibid.*, **71**, 255).
- Larsen, W. A. and S. J. McCleary [1972], "The use of partial residual plots in regression analysis," *Technometrics*, **14**, 781–790.
- Lawless, J.F. [1978], "Ridge and related estimation procedures: Theory and practice," *Commun. Stat.*, **A7**, 139–164.
- Lawless, J. F. and P. Wang [1976], "A simulation of ridge and other regression estimators," *Commun. Stat.*, **A5**, 307–323.
- Lawrence, K. D. and J. L. Arthur [1990], "Robust nonlinear regression," in K. D. Lawrence and J. L. Arthur (Eds.), *Robust Regression: Analysis and Applications*, Dekker, New York, pp. 59–86.

- Lawson, C. R. and R. J. Hanson [1974], *Solving Least Squares Problems*, Prentice-Hall, Englewood Cliffs, N.J.
- Leamer, E. E. [1973], "Multicollinearity: A Bayesian interpretation," *Rev. Econ. Stat.*, **55**, 371–380.
- Leamer, E. E. [1978], *Specification Searches: Ad Hoc Inference with Nonexperimental Data*, Wiley, New York.
- Levine, H. [1960], "Robust tests for equality of variances," in I. Olkin (Ed.), *Contributions to Probability and Statistics*, Stanford University Press, Palo Alto, Calif., pp. 278–292.
- Lieberman, G. J., R. G. Miller, Jr., and M. A. Hamilton [1967], "Unlimited simultaneous discrimination intervals in regression," *Biometrika*, **54**, 133–145.
- Lindley, D. V. [1974], "Regression lines and the linear functional relationship," *J. R. Stat. Soc. Suppl.*, **9**, 218–244.
- Lindley, D. V. and A. F. M. Smith [1972], "Bayes estimates for the linear model (with discussion)," *J. R. Stat. Soc. Ser. B*, **34**, 1–41.
- Looney, S. W. and T. R. Gullledge, Jr. [1985], "Use of the correlation coefficient with normal probability plots," *Am. Stat.*, **35**, 75–79.
- Lowerre, J. M. [1974], "On the mean square error of parameter estimates for some biased estimators," *Technometrics*, **16**, 461–464.
- McCarthy, P. J. [1976], "The use of balanced half-sample replication in cross-validation studies," *J. Am. Stat. Assoc.*, **71**, 596–604.
- McCullagh, P. and J. A. Nelder [1989], *Generalized Linear Models*, 2nd ed., Chapman & Hall, London.
- McDonald, G. C. and J. A. Ayers [1978], "Some applications of 'Chernuff faces': A technique for graphically representing multivariate data," in *Graphical Representation of Multivariate Data*, Academic Press, New York.
- McDonald, G. C. and D. I. Galarneau [1975], "A Monte Carlo evaluation of some ridge-type estimators," *J. Am. Stat. Assoc.*, **70**, 407–416.
- Mallows, C. L. [1964], "Choosing variables in a linear regression: A graphical aid," presented at the Central Regional Meeting of the Institute of Mathematical Statistics, Manhattan, Kans.
- Mallows, C. L. [1966], "Choosing a subset regression," presented at the Joint Statistical Meetings, Los Angeles.
- Mallows, C. L. [1973], "Some comments on C_p ," *Technometrics*, **15**, 661–675.
- Mallows, C. L. [1986], "Augmented partial residuals," *Technometrics*, **28**, 313–319.
- Mallows, C. L. [1995], "More comments on C_p ," *Technometrics*, **37**, 362–372. (Also see [1997], **39**, 115–116.)
- Mandansky, A. [1959], "The fitting of straight lines when both variables are subject to error," *J. Am. Stat. Assoc.*, **54**, 173–205.
- Mansfield, E. R. and M. D. Conerly [1987], "Diagnostic value of residual and partial residual plots," *Am. Stat.*, **41**, 107–116.
- Mansfield, E. R., J. T. Webster, and R. F. Gunst [1977], "An analytic variable selection procedure for principal component regression," *Appl. Stat.*, **26**, 34–40.
- Mantel, N. [1970], "Why stepdown procedures in variable selection," *Technometrics*, **12**, 621–625.
- Marazzi, A. [1993], *Algorithms, Routines and S Functions for Robust Statistics*, Wadsworth and Brooks/Cole, Pacific Grove, Calif.
- Maronna, R. A. [1976], "Robust M -estimators of multivariate location and scatter," *Ann. Stat.*, **4**, 51–67.

- Marquardt, D. W. [1963], "An algorithm for least squares estimation of nonlinear parameters," *J. Soc. Ind. Appl. Math.*, **2**, 431–441.
- Marquardt, D. W. [1970], "Generalized inverses, ridge regression, biased linear estimation, and nonlinear estimation," *Technometrics*, **12**, 591–612.
- Marquardt, D. W. and R. D. Snee [1975], "Ridge regression in practice," *Am. Stat.*, **29**(1), 3–20.
- Mason, R. L., R. F. Gunst, and J. T. Webster [1975], "Regression analysis and problems of multicollinearity," *Commun. Stat.*, **4**(3), 277–292.
- Mayer, L. S. and T. A. Willke [1973], "On biased estimation in linear models," *Technometrics*, **16**, 494–508.
- Meyer, R. K. and C. J. Nachtsheim [1995], "The coordinate exchange algorithm for constructing exact optimal designs," *Technometrics*, **37**, 60–69.
- Miller, D. M. [1984], "Reducing transformation bias in curve fitting," *Am. Stat.*, **38**, 124–126.
- Miller, R. G., Jr. [1966], *Simultaneous Statistical Inference*, McGraw-Hill, New York.
- Montgomery, D. C. [2009], *Design and Analysis of Experiments*, 7th ed., Wiley, New York.
- Montgomery, D. C., L. A. Johnson, and J. S. Gardiner [1990], *Forecasting and Time Series Analysis*, 2nd ed., McGraw-Hill, New York.
- Montgomery, D. C., C. L. Jennings, and M. Kulahci [2008], *Introduction to Time Series Analysis and Forecasting*, Wiley, Hoboken, N.J.
- Montgomery, D. C., E. W. Martin, and E. A. Peck [1980], "Interior analysis of the observations in multiple linear regression," *J. Qual. Technol.*, **12**(3), 165–173.
- Morgan, J. A. and J. F. Tatar [1972], "Calculation of the residual sum of squares for all possible regressions," *Technometrics*, **14**, 317–325.
- Mosteller, F. and J. W. Tukey [1968], "Data analysis including statistics," in G. Lindzey and E. Aronson (Eds.), *Handbook of Social Psychology*, Vol. 2, Addison-Wesley, Reading, Mass.
- Mosteller, F. and J. W. Tukey [1977], *Data Analysis and Regression: A Second Course in Statistics*, Addison-Wesley, Reading, Mass.
- Moussa-Hamouda, E. and F. C. Leone [1974], "The 0-blue estimators for complete and censored samples in linear regression," *Technometrics*, **16**, 441–446.
- Moussa-Hamouda, E. and F. C. Leone [1977a], "The robustness of efficiency of adjusted trimmed estimators in linear regression," *Technometrics*, **19**, 19–34.
- Moussa-Hamouda, E. and F. C. Leone [1977b], "Efficiency of ordinary least squares from trimmed and Winsorized samples in linear regression," *Technometrics*, **19**, 265–273.
- Mullet, G. M. [1976], "Why regression coefficients have the wrong sign," *J. Qual. Technol.*, **8**, 121–126.
- Myers, R. H. [1990], *Classical and Modern Regression with Applications*, 2nd ed., PWS-Kent Publishers, Boston.
- Myers, R. H. and D. C. Montgomery [1997], "A tutorial on generalized linear models," *Journal of Quality Technology*, **29**, 274–291.
- Myers, R. H., D. C. Montgomery, and C. M. Anderson-Cook [2009], *Response Surface Methodology: Process and Product Optimization Using Designed Experiments*, 3rd ed., Wiley, New York.
- Myers, R. H., D. C. Montgomery, G. G. Vining, and T. J. Robinson [2010], *Generalized Linear Models with Applications in Engineering and the Sciences*, Wiley, Hoboken, NJ.
- Narula, S. and J. S. Ramberg [1972], Letter to the Editor, *Am. Stat.*, **26**, 42.
- Naszódi, L. J. [1978], "Elimination of the bias in the course of calibration," *Technometrics*, **20**, 201–205.

- Nelder, J. A. and R. W. M. Wedderburn [1972], "Generalized linear models," *J. R. Stat. Soc. Ser. A*, **153**, 370–384;
- Neter, J., M. H. Kutner, C. J. Nachtsheim, and W. Wasserman [1996], *Applied Linear Statistical Models*, 4th ed., Richard D. Irwin, Homewood, Ill.
- Neyman, J. and E. L. Scott [1960], "Correction for bias introduced by a transformation of variables," *Ann. Math. Stat.*, **31**, 643–655.
- Obenchain, R. L. [1975], "Ridge analysis following a preliminary test of the shrunken hypothesis," *Technometrics*, **17**, 431–441.
- Obenchain, R. L. [1977], "Classical F -tests and confidence intervals for ridge regression," *Technometrics*, **19**, 429–439.
- Ott, R. L. and R. H. Myers [1968], "Optimal experimental designs for estimating the independent variable in regression," *Technometrics*, **10**, 811–823.
- Parker, P. A., G. G. Vining, S. A. Wilson, J. L. Szarka, III, and N. G. Johnson [2010], "Prediction properties of classical and inverse regression for the simple linear calibration problem," *J. Qual. Technol.*, **42**, 332–347.
- Pearson, E. S. and H. O. Hartley [1966], *Biometrika Tables for Statisticians*, Vol. 1, 3rd ed., Cambridge University Press, London.
- Peixoto, J. L. [1987], "Hierarchical variable selection in polynomial regression models," *Am. Stat.*, **41**, 311–313.
- Peixoto, J. L. [1990], "A property of well-formulated polynomial regression models," *Am. Stat.*, **44**, 26–30. (Also see [1991], **45**, 82.)
- Pena, D. and V. J. Yohai [1995], "The detection of influential subsets in linear regression by using an influence matrix," *J. R. Stat. Soc. Ser. B*, **57**, 145–156.
- Perng, S. K. and Y. L. Tong [1974], "A sequential solution to the inverse linear regression problem," *Ann. Stat.*, **2**, 535–539.
- Pesaran, M. H. and L. J. Slater [1980], *Dynamic Regression: Theory Algorithms*, Halsted Press, New York.
- Pfaffenberger, R. C. and T. E. Dielman [1985], "A comparison of robust ridge estimators," in *Business and Economics Section Proceedings of the American Statistical Association*, pp. 631–635.
- Poirier, D. J. [1973], "Piecewise regression using cubic splines," *J. Am. Stat. Assoc.*, **68**, 515–524.
- Poirier, D. J. [1975], "On the use of bilinear splines in economics," *J. Econ.*, **3**, 23–24.
- Pope, P. T. and J. T. Webster [1972], "The use of an F -statistic in stepwise regression procedures," *Technometrics*, **14**, 327–340.
- Pukelsheim, F. [1995], *Optimum Design of Experiments*, Chapman & Hall, London.
- Ramsay, J. O. [1977], "A comparative study of several robust estimates of slope, intercept, and scale in linear regression," *J. Am. Stat. Assoc.*, **72**, 608–615.
- Rao, P. [1971], "Some notes on misspecification in regression," *Am. Stat.*, **25**, 37–39.
- Ripley, B. D. [1994], "Statistical ideas for selecting network architectures," in B. Kappen and S. Grielen (Eds.), *Neural Networks: Artificial Intelligence Industrial Applications*, Springer-Verlag, Berlin, pp. 183–190.
- Rocke, D. M. and D. L. Woodruff [1996], "Identification of outliers in multivariate data," *J. Am. Stat. Assoc.*, **91**, 1047–1061.
- Rosenberg, S. H. and P. S. Levy [1972], "A characterization on misspecification in the general linear regression model," *Biometrics*, **28**, 1129–1132.
- Rossmann, A. J. [1994], "Televisions, physicians and life expectancy," *J. Stat. Educ.*, **2**.
- Rousseeuw, P. J. [1984], "Least median of squares regression," *J. Am. Stat. Assoc.*, **79**, 871–880.

- Rousseeuw, P. J. [1998], "Robust estimation and identifying outliers," in H. M. Wadsworth (Ed.), *Handbook of Statistical Methods for Engineers and Scientists*, McGraw-Hill, New York, Chapter 17.
- Rousseeuw, P. J. and A. M. Leroy [1987], *Robust Regression and Outlier Detection*, Wiley, New York.
- Rousseeuw, P. J. and B. L. van Zomeren [1990], "Unmasking multivariate outliers and leverage points," *J. Am. Stat. Assoc.*, **85**, 633–651.
- Rousseeuw, P. J., and V. Yohai [1984], "Robust regression by means of S-estimators," in J. Franke, W. Härdle, and R. D. Martin (Eds.), *Robust Nonlinear Time Series Analysis: Lecture Notes in Statistics*, Vol. 26, Springer, Berlin, pp. 256–272.
- Ryan, T. P. [1997], *Modern Regression Methods*, Wiley, New York.
- SAS Institute [1987], *SAS Views: SAS Principles of Regression Analysis*, SAS Institute, Cary, N.C.
- Sawa, T. [1978], "Information criteria for discriminating among alternative regression models," *Econometrica*, **46**, 1273–1282.
- Schatzoff, M., R. Tsao, and S. Fienberg [1968], "Efficient calculation of all possible regressions," *Technometrics*, **10**, 769–779.
- Scheffé, H. [1953], "A method for judging all contrasts in the analysis of variance," *Ann. Math. Stat.*, **40**, 87–104.
- Scheffé, H. [1959], *The Analysis of Variance*, Wiley, New York.
- Scheffé, H. [1973], "A statistical theory of calibration," *Ann. Stat.*, **1**, 1–37.
- Schilling, E. G. [1974a], "The relationship of analysis of variance to regression. Part I. Balanced designs," *J. Qual. Technol.*, **6**, 74–83.
- Schilling, E. G. [1974b], "The relationship of analysis of variance to regression. Part II. Unbalanced designs," *J. Qual. Technol.*, **6**, 146–153.
- Sclove, S. L. [1968], "Improved estimators for coefficients in linear regression," *J. Am. Stat. Assoc.*, **63**, 596–606.
- Searle, S. R. [1971], *Linear Models*, Wiley, New York.
- Searle, S. R. and J. G. Udell [1970], "The use of regression on dummy variables in market research," *Manage. Sci. B*, **16**, 397–409.
- Seber, G. A. F. [1977], *Linear Regression Analysis*, Wiley, New York.
- Sebert, D. M., D. C. Montgomery, and D. A. Rollier [1998], "A clustering algorithm for identifying multiple outliers in linear regression," *Comput. Stat. Data Anal.*, **27**, 461–484.
- Sielken, R. L., Jr. and H. O. Hartley [1973], "Two linear programming algorithms for unbiased estimation of linear models," *J. Am. Stat. Assoc.*, **68**, 639–641.
- Silvey, S. D. [1969], "Multicollinearity and imprecise estimation," *J. R. Stat. Soc. Ser. B*, **31**, 539–552.
- Simpson, D. G., D. Ruppert, and R. J. Carroll [1992], "On one-step GM-estimates and stability of inference in linear regression," *J. Am. Stat. Assoc.*, **87**, 439–450.
- Simpson, J. R. and D. C. Montgomery [1996], "A biased-robust regression technique for the combined-outlier multicollinearity problem," *J. Stat. Comput. Simul.*, **56**, 1–22.
- Simpson, J. R. and D. C. Montgomery [1998a], "A robust regression technique using compound estimation," *Nov. Res. Logistics*, **45**, 125–139.
- Simpson, J. R. and D. C. Montgomery [1998b], "The development and evaluation of alternative generalized M-estimation techniques," *Commun. Stat. Simul. Comput.*, **27**, 999–1018.
- Simpson, J. R. and D. C. Montgomery [1998c], "A performance-based assessment of robust regression methods," *Commun. Stat. Simul. Comput.*, **27**, 1031–1099.

- Smith, A. F. M. and M. Goldstein [1975], "Ridge regression: Some comments on a paper of Conniffe and Stone," *The Statistician*, **24**, 61–66.
- Smith, B. T., J. M. Boyle, B. S. Garbow, Y. Ikebe, V. C. Klema, and C. B. Moler [1974], *Matrix Eigensystem Routines*, Springer-Verlag, Berlin.
- Smith, G. and F. Campbell [1980], "A critique of some ridge regression methods (with discussion)," *J. Am. Stat. Assoc.*, **75**, 74–103.
- Smith, J. H. [1972], "Families of transformations for use in regression analysis," *Am. Stat.*, **26**(3), 59–61.
- Smith, P. L. [1979], "Splines as a useful and convenient statistical tool," *Am. Stat.*, **33**(2), 57–62.
- Smith, R. C. et al. [1992], "Ozone depletion: Ultraviolet radiation and phytoplankton biology in Antarctic waters," *Science*, **255**, 952–957.
- Snee, R. D. [1973], "Some aspects of nonorthogonal data analysis, Part I. Developing prediction equations," *J. Qual. Technol.*, **5**, 67–79.
- Snee, R. D. [1977], "Validation of regression models: Methods and examples," *Technometrics*, **19**, 415–428.
- Sprent, P. [1969], *Models in Regression and Related Topics*, Methuen, London.
- Sprent, P. and G. R. Dolby [1980], "The geometric mean functional relationship," *Biometrics*, **36**, 547–550.
- Staudte, R. G. and S. J. Sheather [1990], *Robust Estimation and Testing*, Wiley, New York.
- Stefanski, W. [1991], "A note on high-breakdown estimators," *Stat. Probab. Lett.*, **11**, 353–358.
- Stefansky, W. [1971], "Rejecting outliers by maximum normed residual," *Ann. Math. Stat.*, **42**, 35–45.
- Stefansky, W. [1972], "Rejecting outliers in factorial designs," *Technometrics*, **14**, 469–479.
- Stein, C. [1960], "Multiple regression," in I. Olkin (Ed.), *Contributions to Probability and Statistics: Essays in Honor of Harold Hotelling*, Stanford Press, Stanford, Calif.
- Stewart, G. W. [1973], *Introduction to Matrix Computations*, Academic, New York.
- Stone, M. [1974], "Cross-validating choice and assessment of statistical predictions (with discussion)," *J. R. Stat. Soc. Ser. B*, **36**, 111–147.
- Stromberg, A. J. [1993], "Computation of high breakdown nonlinear regression parameters," *J. Am. Stat. Assoc.*, **88**, 237–244.
- Stromberg, A. J. and D. Ruppert [1989], "Breakdown in nonlinear regression," *J. Am. Stat. Assoc.*, **83**, 991–997.
- Suich, R. and G. C. Derringer [1977], "Is the regression equation adequate—one criterion," *Technometrics*, **19**, 213–216.
- Schwartz, G. [1978], "Estimating the dimension of a model," *Ann. Stat.*, **6**, 461–464.
- Theobald, C. M. [1974], "Generalizations of mean square error applied to ridge regression," *J. R. Stat. Soc. Ser. B*, **36**, 103–106.
- Thompson, M. L. [1978a], "Selection of variables in multiple regression: Part I. A review and evaluation," *Int. Stat. Rev.*, **46**, 1–19.
- Thompson, M. L. [1978b], "Selection of variables in multiple regression: Part II. Chosen procedures, computations and examples," *Int. Stat. Rev.*, **46**, 129–146.
- Tucker, W. T. [1980], "The linear calibration problem revisited," presented at the ASQC Fall Technical Conference, Cincinnati, Ohio.
- Tufte, E. R. [1974], *Data Analysis for Politics and Policy*, Prentice-Hall, Englewood Cliffs, N.J.
- Tukey, J. W. [1957], "On the comparative anatomy of transformations," *Ann. Math. Stat.*, **28**, 602–632.

- Wagner, H. M. [1959], "Linear programming techniques for regression analysis," *J. Am. Stat. Assoc.*, **54**, 206–212.
- Wahba, G., G. H. Golub, and C. G. Health [1979], "Generalized cross-validation as a method for choosing a good ridge parameter," *Technometrics*, **21**, 215–223.
- Walker, E. [1984], *Influence, Collinearity, and Robust Estimation in Regression*, Ph.D. dissertation, Department of Statistics, Virginia Tech, Blacksburg.
- Walker, E. and J. B. Birch [1988], "Influence measures in ridge regression," *Technometrics*, **30**, 221–227.
- Walls, R. E. and D. L. Weeks [1969], "A note on the variance of a predicted response in regression," *Am. Stat.*, **23**, 24–26.
- Webster, J. T., R. F. Gunst, and R. L. Mason [1974], "Latent root regression analysis," *Technometrics*, **16**, 513–522.
- Weisberg, S. [1985], *Applied Linear Regression*, 2nd ed., Wiley, New York.
- Welsh, R. E. [1975], "Confidence regions for robust regression," in *Statistical Computing Section Proceedings of the American Statistical Association*, Washington, D.C.
- Welsh, R. E. and S. C. Peters [1978], "Finding influential subsets of data in regression models," in A. R. Gallant and T. M. Gerig (Eds.), *Proceedings of the Eleventh Interface Symposium on Computer Science and Statistics*, Institute of Statistics, North Carolina State University, pp. 240–244.
- White, J. W. and R. F. Gunst [1979], "Latent root regression: Large sample analysis," *Technometrics*, **21**, 481–488.
- Wichern, D. W., and G. A. Churchill [1978], "A comparison of ridge estimators," *Technometrics*, **20**, 301–311.
- Wilcox, R. R. [1997], *Introduction to Robust Estimation and Hypothesis Testing*, Academic, New York.
- Wilde, D. J. and C. S. Beightler [1967], *Foundations of Optimization*, Prentice-Hall, Englewood Cliffs, N.J.
- Wilkinson, J. W. [1965], *The Algebraic Eigenvalue Problem*, Oxford University Press, London.
- Willan, A. R. and D. G. Watts [1978], "Meaningful multicollinearity measures," *Technometrics*, **20**, 407–412.
- Williams, D. A. [1973], Letter to the Editor, *Appl. Stat.*, **22**, 407–408.
- Williams, E. J. [1969], "A note on regression methods in calibration," *Technometrics*, **11**, 189–192.
- Wold, S. [1974], "Spline functions in data analysis," *Technometrics*, **16**, 1–11.
- Wonnacott, R. J. and T. H. Wonnacott [1970], *Econometrics*, Wiley, New York.
- Wood, F. S. [1973], "The use of individual effects and residuals in fitting equations to data," *Technometrics*, **15**, 677–695.
- Working, H. and H. Hotelling [1929], "Application of the theory of error to the interpretation of trends," *J. Am. Stat. Assoc. Suppl. (Proc.)*, **24**, 73–85.
- Wu, C. F. J. [1986], "Jackknife, bootstrap, and other resampling methods in regression analysis (with discussion)," *Ann. Stat.*, **14**, 1261–1350.
- Yale, C. and A. B. Forsythe [1976], "Winsorized regression," *Technometrics*, **18**, 291–300.
- Yohai, V. J. [1987], "High breakdown-point and high efficiency robust estimates for regression," *Ann. Stat.*, **15**, 642–656.
- Younger, M. S. [1979], *A Handbook for Linear Regression*, Duxbury Press, North Scituate, Mass.
- Zellner, A. [1971], *An Introduction to Bayesian Inference in Econometrics*, Wiley, New York.

INDEX

- Activation function in a neural network, 527
- Adjusted R^2 , 87, 333
- Akaike information criterion (AIC), 336
- All possible regressions, 336, 342
- Allocated codes and indicator variables, 273
- Analysis of covariance, 272
- Analysis of variance (ANOVA) in regression, 25, 84
- Analysis of variance identity for regression, 26
- Analysis of variance model as a regression model, 275
- Artificial neural networks, 526
- Assumptions in regression, 129
- Asymptotic covariance matrix, 406
- Asymptotic efficiency, 511
- Asymptotic inference in nonlinear regression, 409, 411
- Asymptotically unbiased estimators, 52
- Autocorrelation function, 475
- Autocorrelation in regression data, 474
- Average prediction variance, 531

- Backpropagation, 528
- Backward elimination, 346
- Bayesian estimation, 312
- Bernoulli random variable, 432

- Best linear unbiased estimators, 19, 587
- Biassing parameter in ridge regression, 306
- BIC, 336
- Binary response variable, 422. *See also* Logistic regression
- Binomial distribution, 422, 608
- Bivariate normal distribution, 53
- Bonferroni method for confidence intervals, 102
- Bootstrap confidence intervals, 519
- Bootstrapping, 411, 517
 - cases, 518
 - residuals, 518
- Box–Behnken design, 532
- Box–Cox method, 182
- Breakdown point, 510

- Calibration problem, 513, 516
- Candidate regressors, 328
- Canonical link, 451
- Categorical variables in regression, 260
- Central composite design, 243, 532
- Central limit theorem, 575
- Chi-square distribution, definition, 575
- Classical calibration estimator, 514
- Classification and regression trees (CART), 524

- Cluster analysis to identify jointly influential points, 220
- Cochrane–Orcutt method, 482
- Coefficient of determination, 35.
See also R^2
- Collinearity, 7. *See also* Multicollinearity
- Comparing regression models, 272
- Complimentary log-log link, 442, 452
- Condition indices of $\mathbf{X}'\mathbf{X}$, 298
- Condition number of $\mathbf{X}'\mathbf{X}$, 298
- Confidence interval
 - in logistic regression, 437
 - on the mean response, 30, 46, 99
 - on model parameters, 29, 46, 98
- Consistent estimators, 52
- Cook's distance measure, 216, 600
- Correlation coefficient, 53
- Correlation matrix
 - of the parameter estimates, 80
 - of the regressors, 114, 292
 - as a multicollinearity diagnostic, 292, 294
- $COVRATIO_i$, 219
- Cubic splines, 230, 231
- Cuboidal design region, 533

- Degrees of freedom in ANOVA, 26
- Deleted residuals, 134
- Deletion diagnostic, 217
- Dependent variable, 2
- Designed experiment, 5, 8, 71, 243, 275, 529, 530
- Detecting multicollinearity, 292
- Determinant of $\mathbf{X}'\mathbf{X}$, 302
- Deviance, 431, 525
 - residuals, 440, 458
- $DFBETAS_{ij}$, 217, 601
- $DFFFITS_i$, 217, 600
- D -optimal design, 530
- Double exponential distribution, 502
- Durbin–Watson test for autocorrelation, 475, 477

- Efficiency of an estimator, 511
- Eigenvalues of $\mathbf{X}'\mathbf{X}$, 299
- Empirical model, 3, 68
- Empirical selection of a transformation, 172
- Errors in the regressor variables, 511
- Estimation of σ^2 , 21
- Exponential family, 421, 450, 605
- Externally studentized residuals, 135

- Extra sum of squares method, 89, 585
- Extrapolation in regression, 33, 42, 107, 225
- Extreme values, 130

- Factorial design, 529
- F -distribution (definition), 576
- Finite-sample efficiency, 511
- First-order autoregressive process, 475
- Forward selection, 345
- Fraction of design space plot, 536
- Fractional increments, 408

- Gauss–Markov theorem, 19, 587, 597
- Generalized least squares, 188, 189
- Generalized linear model, 421, 450
- Generalized ridge regression, 313
- Gompertz growth model, 412
- Goodness of fit tests in logistic regression, 431, 432
- G -optimal design, 531
- Growth models, 412

- Hat matrix in regression, 73, 110, 131, 212
- Hessian matrix, 437
- Hidden extrapolation in regression, 107
- Hierarchy, 226, 395, 396
- High-breakdown-point estimators, 510
- Hosmer–Lemeshow goodness-of-fit test, 433

- Idempotent matrix (definition), 577
- Identity link, 445
- Ill-conditioning, 226. *See also* Multicollinearity
- Independent variable, 2
- Indicator variables, 260, 268, 270, 173, 274, 275
- Influence function, 504
- Influential point, 132, 134, 211, 220
- Integrated variance, 531
- Interaction, 69
- Intrinsically linear model, 176, 178, 398
- Inverse estimation, 513, 516
- I -optimal design, 532
- Iteratively reweighted least squares (IRLS), 503, 605, 611

- Joint confidence region on the model parameters, 101
- Jointly influential points, 220

- Lack of fit test in regression, 156, 159, 162
- Lag one autocorrelation, 476

- Least absolute deviation (L_1 norm) regression, 502
- Least squares
 - estimators, 14, 72, 73
 - normal equations, 14, 71, 72
- Leverage point, 132, 211, 212, 213
- Likelihood function, 51
- Likelihood ratio tests in logistic regression, 430
- Linear dependence of regressors, 117
- Linear predictor, 423, 451
- Linear regression model, 2, 389
- Linearization of a nonlinear model, 400
- Linearly independent regressors, 73
- Link function, 445
- Locally weighted regression (Loess), 237, 239
- Log link, 445
- Logistic growth model, 412
- Logistic regression, 421, 423, 428, 430, 432, 433, 437, 440, 442, 444
- Logistic response function, 423

- Mallow's C_p , 334
- Marquardt's compromise, 408
- Matrix of scatter plots, 82
- Maximum likelihood estimation
 - in the generalized linear model, 452, 454, 608
 - in logistic regression, 424, 601
 - in time series regression models, 485
- Maximum likelihood estimators, 51, 83
- Maximum likelihood score equations, 602
- Mean shift outlier model, 594
- Mechanistic model, 3, 411
- M -estimators, 503, 509
- Method of least squares, 13, 70, 395
- Method of maximum likelihood, 51
- Method of steepest decent, 407
- Minimum variance estimators, 52
- Mixed model, 195, 202
- Model adequacy checking, 4, 15, 129, 130, 136, 139, 141, 142, 143, 149, 475
- Model building, 91, 225, 304, 327, 338, 345, 346, 348, 351
- Model independent estimate of error, 157, 160
- Model misspecification, 329
- Model-dependent estimate of error, 21, 81
- Multicollinearity, 7, 117, 285, 292, 396
 - effects, 288
- Multiple linear regression model, 4, 67

- Near neighbors, 160
- Neural networks, 526
- Newton–Raphson method, 603
- No-intercept regression model, 45
- Nominal logistic regression, 442
- Noncentral chi-square distribution (definition), 576
- Noncentral F distribution (definition), 576
- Noncentral t distribution (definition), 575
- Nonlinear least squares, 396
- Nonlinear regression model, 389
- Nonparametric regression, 236, 237
- Nonsense relationships in regression, 44
- Normal distribution, 22, 129, 136, 574, 606
- Normal probability plot of residuals, 136

- Observational study, 5, 8, 71
- Odds ratio, 428, 429
- Ordinal logistic regression, 444
- Orthogonal design, 530
- Orthogonal polynomials, 248
- Orthogonal regressors, 93, 118
- Orthonormal matrix (definition), 578
- Outliers, 7, 43, 139, 59
- Overdispersion, 461
- Overfitting, 88, 528

- Partial deviance, 434
- Partial F -test, 90
- Partial regression
 - coefficients, 68, 115
 - plots, 143, 144
- Partial residual plots, 143, 146
- Pearson chi-square goodness-of-fit test, 432
- Pearson residuals, 440
- Piecewise polynomial models, 229, 234
- Poisson distribution, 444, 607
- Poisson regression, 444
- Polynomial regression models, 223, 242
- Polynomial and trigonometric terms, 235
- Population regression model, 13
- Positive definite and positive semidefinite matrix, definition, 578
- Power family link, 452
- Power family transformations, 182
- Prediction, 9, 33, 45, 104, 488
 - in time series regression models, 488
- Prediction interval on a new observation, 33, 46, 104, 488, 491
- Predictor variable, 2. *See also* Regressor variable
- PRESS residuals, 134

- PRESS statistic, 151, 152, 337, 591
 Principal component regression, 313, 315
 Principal components, 314
 Probit analysis, 442
 Probit link, 452
 Properties of ridge regression, 309
 Pure error, 157
- Quasi-likelihood, 462
- R^2 , 35, 36, 46, 87, 332
 for prediction, 151
 Random regressor variable, 52
 Rank of a matrix, definition, 577
 Regression analysis, 1
 Regression coefficients, 13
 Regression models
 with concurrent lines, 27
 with parallel lines, 272
 with random effects, 194
 Regression or model sum of squares, 26, 84, 86
 Regressor variable, 2, 52, 68, 73, 93, 118, 184, 260, 273, 274, 275, 285, 292, 328, 511
 REML, 196, 200, 201
 Residual analysis, 22, 130, 328
 Residual mean square, 21, 80, 333
 Residual plotting, 130, 136, 139, 141, 142, 143, 149, 475
 Residual sum of squares, 20, 84, 86
 Residuals, 73, 130
 Response surface, 242
 methodology, 242, 532
 Response variable, 2, 68, 422, 444
 Retrospective study, 5, 6
 Ridge regression, 304, 307, 309, 312, 319
 Ridge trace, 307
 Robust estimation of parameters, 221. *See also* Robust regression
 Robust regression, 500, 502, 503, 504, 510
 Rotatability, 248, 533
R-student, 135
- Sample correlation coefficient, 53
 Sample regression model, 13
 Scaled residuals, 130
 Scatter diagram, 1, 82
 Second-order model, 69, 242
 Sherman–Morrison–Woodbury theorem, 590
 Shrinkage estimators, 310
 Significance of regression, 24, 25, 28, 84
 Simple linear regression model, 2, 12
- Simultaneous inference, 33, 100, 102, 103
 Singular value decomposition, 299
 Sources of multicollinearity in regression, 286
 Spherical design region, 533
 Splines, 229
 Standard error of parameter estimates, 23
 Standard error of regression, 21
 Standardized Pearson residuals, 437
 Standardized regression coefficients, 111, 115
 Standardized residuals, 130
 Starting values in nonlinear regression, 408
 Statistical tests on residuals, 150
 Stepwise regression, 345, 348, 350
 Strength of a transformation, 172
 Studentized residuals, 131
 Sufficient statistics, 52
- t*-distribution (definition), 576
 Testing the equality of regression coefficients, 96
 Testing the general linear hypothesis, 95
 Tests based on deviance, 433
 Time series data, 474
 Trace of a matrix (definition), 578
 Transformation of the regressor variables, 184, 187
 Transformations, 139, 171, 176, 182, 184, 224, 397
 to linearize a model, 397
t-tests on model parameters, 22, 28, 55, 88, 585
- Unbiased estimators, 18, 52, 79, 81
 Unit length scaling, 114, 117
 Unit normal scaling, 113
- Variable selection in regression, 88, 327, 338, 342, 346, 348, 351
 Variance decomposition proportions, 300
 Variance inflation factors, 118, 296
 Variance stabilizing transformations, 172
 Vector of increments, 401
V-optimal design, 531
- Wald inference, 436
 Weibull growth model, 412
 Weighted least squares, 188, 190
 estimator, 190, 191
 Woodbury matrix identity, 590
 Wrong signs for regression coefficients, 119

WILEY SERIES IN PROBABILITY AND STATISTICS

ESTABLISHED BY WALTER A. SHEWHART AND SAMUEL S. WILKS

Editors: *David J. Balding, Noel A. C. Cressie, Garrett M. Fitzmaurice, Harvey Goldstein, Iain M. Johnstone, Geert Molenberghs, David W. Scott, Adrian F. M. Smith, Ruey S. Tsay, Sanford Weisberg*

Editors Emeriti: *Vic Barnett, J. Stuart Hunter, Joseph B. Kadane, Jozef L. Teugels*

The *Wiley Series in Probability and Statistics* is well established and authoritative. It covers many topics of current research interest in both pure and applied statistics and probability theory. Written by leading statisticians and institutions, the titles span both state-of-the-art developments in the field and classical methods.

Reflecting the wide range of current research in statistics, the series encompasses applied, methodological and theoretical statistics, ranging from applications and new techniques made possible by advances in computerized practice to rigorous treatment of theoretical approaches.

This series provides essential and invaluable reading for all statisticians, whether in academia, industry, government, or research.

- † ABRAHAM and LEDOLTER · Statistical Methods for Forecasting
AGRESTI · Analysis of Ordinal Categorical Data, *Second Edition*
AGRESTI · An Introduction to Categorical Data Analysis, *Second Edition*
AGRESTI · Categorical Data Analysis, *Second Edition*
ALTMAN, GILL, and McDONALD · Numerical Issues in Statistical Computing
for the Social Scientist
AMARATUNGA and CABRERA · Exploration and Analysis of DNA
Microarray and Protein Array Data
ANDĚL · Mathematics of Chance
ANDERSON · An Introduction to Multivariate Statistical Analysis, *Third
Edition*
* ANDERSON · The Statistical Analysis of Time Series
ANDERSON, AUQUIER, HAUCK, OAKES, VANDAELE, and WEISBERG ·
Statistical Methods for Comparative Studies
ANDERSON and LOYNES · The Teaching of Practical Statistics
ARMITAGE and DAVID (editors) · Advances in Biometry
ARNOLD, BALAKRISHNAN, and NAGARAJA · Records
* ARTHANARI and DODGE · Mathematical Programming in Statistics
* BAILEY · The Elements of Stochastic Processes with Applications to the
Natural Sciences
BAJORSKI · Statistics for Imaging, Optics, and Photonics
BALAKRISHNAN and KOUTRAS · Runs and Scans with Applications

* Now available in a lower priced paperback edition in the Wiley Classics Library.

† Now available in a lower priced paperback edition in the Wiley-Interscience Paperback Series.

BALAKRISHNAN and NG · Precedence-Type Tests and Applications

BARNETT · Comparative Statistical Inference, *Third Edition*

BARNETT · Environmental Statistics

BARNETT and LEWIS · Outliers in Statistical Data, *Third Edition*

BARTOSZYNSKI and NIEWIADOMSKA-BUGAJ · Probability and Statistical Inference

BASILEVSKY · Statistical Factor Analysis and Related Methods: Theory and Applications

BASU and RIGDON · Statistical Methods for the Reliability of Repairable Systems

BATES and WATTS · Nonlinear Regression Analysis and Its Applications

BECHHOFFER, SANTNER, and GOLDSMAN · Design and Analysis of Experiments for Statistical Selection, Screening, and Multiple Comparisons

BEIRLANT, GOEGEBEUR, SEGERS, TEUGELS, and DE WAAL · Statistics of Extremes: Theory and Applications

BELSLEY · Conditioning Diagnostics: Collinearity and Weak Data in Regression

† BELSLEY, KUH, and WELSCH · Regression Diagnostics: Identifying Influential Data and Sources of Collinearity

BENDAT and PIERSOL · Random Data: Analysis and Measurement Procedures, *Fourth Edition*

BERNARDO and SMITH · Bayesian Theory

BERRY, CHALONER, and GEWEKE · Bayesian Analysis in Statistics and Econometrics: Essays in Honor of Arnold Zellner

BHAT and MILLER · Elements of Applied Stochastic Processes, *Third Edition*

BHATTACHARYA and WAYMIRE · Stochastic Processes with Applications

BIEMER, GROVES, LYBERG, MATHIOWETZ, and SUDMAN · Measurement Errors in Surveys

BILLINGSLEY · Convergence of Probability Measures, *Second Edition*

BILLINGSLEY · Probability and Measure, *Anniversary Edition*

BIRKES and DODGE · Alternative Methods of Regression

BISGAARD and KULAHCI · Time Series Analysis and Forecasting by Example

BISWAS, DATTA, FINE, and SEGAL · Statistical Advances in the Biomedical Sciences: Clinical Trials, Epidemiology, Survival Analysis, and Bioinformatics

BLISCHKE AND MURTHY (editors) · Case Studies in Reliability and Maintenance

BLISCHKE AND MURTHY · Reliability: Modeling, Prediction, and Optimization

BLOOMFIELD · Fourier Analysis of Time Series: An Introduction, *Second Edition*

BOLLEN · Structural Equations with Latent Variables

†Now available in a lower priced paperback edition in the Wiley–Interscience Paperback Series.

BOLLEN and CURRAN · Latent Curve Models: A Structural Equation Perspective

BOROVKOV · Ergodicity and Stability of Stochastic Processes

BOSQ and BLANKE · Inference and Prediction in Large Dimensions

BOULEAU · Numerical Methods for Stochastic Processes

BOX · Bayesian Inference in Statistical Analysis

BOX · Improving Almost Anything, *Revised Edition*

BOX · R. A. Fisher, the Life of a Scientist

BOX and DRAPER · Empirical Model-Building and Response Surfaces

* BOX and DRAPER · Evolutionary Operation: A Statistical Method for Process Improvement

BOX and DRAPER · Response Surfaces, Mixtures, and Ridge Analyses, *Second Edition*

BOX, HUNTER, and HUNTER · Statistics for Experimenters: Design, Innovation, and Discovery, *Second Edition*

BOX, JENKINS, and REINSEL · Time Series Analysis: Forecasting and Control, *Fourth Edition*

BOX, LUCEÑO, and PANIAGUA-QUIÑONES · Statistical Control by Monitoring and Adjustment, *Second Edition*

BRANDIMARTE · Numerical Methods in Finance: A MATLAB-Based Introduction

† BROWN and HOLLANDER · Statistics: A Biomedical Introduction

BRUNNER, DOMHOF, and LANGER · Nonparametric Analysis of Longitudinal Data in Factorial Experiments

BUCKLEW · Large Deviation Techniques in Decision, Simulation, and Estimation

CAIROLI and DALANG · Sequential Stochastic Optimization

CASTILLO, HADI, BALAKRISHNAN, and SARABIA · Extreme Value and Related Models with Applications in Engineering and Science

CHAN · Time Series: Applications to Finance with R and S-Plus®, *Second Edition*

CHARALAMBIDES · Combinatorial Methods in Discrete Distributions

CHATTERJEE and HADI · Regression Analysis by Example, *Fourth Edition*

CHATTERJEE and HADI · Sensitivity Analysis in Linear Regression

CHERNICK · Bootstrap Methods: A Guide for Practitioners and Researchers, *Second Edition*

CHERNICK and FRIIS · Introductory Biostatistics for the Health Sciences

CHILÈS and DELFINER · Geostatistics: Modeling Spatial Uncertainty, *Second Edition*

CHOW and LIU · Design and Analysis of Clinical Trials: Concepts and Methodologies, *Second Edition*

CLARKE · Linear Models: The Theory and Application of Analysis of Variance

* Now available in a lower priced paperback edition in the Wiley Classics Library.

† Now available in a lower priced paperback edition in the Wiley-Interscience Paperback Series.

CLARKE and DISNEY · Probability and Random Processes: A First Course with Applications, *Second Edition*

* COCHRAN and COX · Experimental Designs, *Second Edition*

COLLINS and LANZA · Latent Class and Latent Transition Analysis: With Applications in the Social, Behavioral, and Health Sciences

CONGDON · Applied Bayesian Modelling

CONGDON · Bayesian Models for Categorical Data

CONGDON · Bayesian Statistical Modelling, *Second Edition*

CONOVER · Practical Nonparametric Statistics, *Third Edition*

COOK · Regression Graphics

COOK and WEISBERG · An Introduction to Regression Graphics

COOK and WEISBERG · Applied Regression Including Computing and Graphics

CORNELL · A Primer on Experiments with Mixtures

CORNELL · Experiments with Mixtures, Designs, Models, and the Analysis of Mixture Data, *Third Edition*

COVER and THOMAS · Elements of Information Theory

COX · A Handbook of Introductory Statistical Methods

* COX · Planning of Experiments

CRESSIE · Statistics for Spatial Data, *Revised Edition*

CRESSIE and WIKLE · Statistics for Spatio-Temporal Data

CSÖRGŐ and HORVÁTH · Limit Theorems in Change Point Analysis

DANIEL · Applications of Statistics to Industrial Experimentation

DANIEL · Biostatistics: A Foundation for Analysis in the Health Sciences, *Eighth Edition*

* DANIEL · Fitting Equations to Data: Computer Analysis of Multifactor Data, *Second Edition*

DASU and JOHNSON · Exploratory Data Mining and Data Cleaning

DAVID and NAGARAJA · Order Statistics, *Third Edition*

* DEGROOT, FIENBERG, and KADANE · Statistics and the Law

DEL CASTILLO · Statistical Process Adjustment for Quality Control

DEMARIS · Regression with Social Data: Modeling Continuous and Limited Response Variables

DEMIDENKO · Mixed Models: Theory and Applications

DENISON, HOLMES, MALLICK and SMITH · Bayesian Methods for Nonlinear Classification and Regression

DETTE and STUDDEN · The Theory of Canonical Moments with Applications in Statistics, Probability, and Analysis

DEY and MUKERJEE · Fractional Factorial Plans

DILLON and GOLDSTEIN · Multivariate Analysis: Methods and Applications

DODGE · Alternative Methods of Regression

*Now available in a lower priced paperback edition in the Wiley Classics Library.

* DODGE and ROMIG · Sampling Inspection Tables, *Second Edition*

* DOOB · Stochastic Processes

DOWDY, WEARDEN, and CHILKO · Statistics for Research, *Third Edition*

DRAPER and SMITH · Applied Regression Analysis, *Third Edition*

DRYDEN and MARDIA · Statistical Shape Analysis

DUDEWICZ and MISHRA · Modern Mathematical Statistics

DUNN and CLARK · Basic Statistics: A Primer for the Biomedical Sciences, *Third Edition*

DUPUIS and ELLIS · A Weak Convergence Approach to the Theory of Large Deviations

EDLER and KITSOS · Recent Advances in Quantitative Methods in Cancer and Human Health Risk Assessment

* ELANDT-JOHNSON and JOHNSON · Survival Models and Data Analysis

ENDERS · Applied Econometric Time Series

† ETHIER and KURTZ · Markov Processes: Characterization and Convergence

EVANS, HASTINGS, and PEACOCK · Statistical Distributions, *Third Edition*

EVERITT · Cluster Analysis, *Fifth Edition*

FELLER · An Introduction to Probability Theory and Its Applications, Volume I, *Third Edition*, Revised; Volume II, *Second Edition*

FISHER and VAN BELLE · Biostatistics: A Methodology for the Health Sciences

FITZMAURICE, LAIRD, and WARE · Applied Longitudinal Analysis, *Second Edition*

* FLEISS · The Design and Analysis of Clinical Experiments

FLEISS · Statistical Methods for Rates and Proportions, *Third Edition*

† FLEMING and HARRINGTON · Counting Processes and Survival Analysis

FUJIKOSHI, ULYANOV, and SHIMIZU · Multivariate Statistics: High-Dimensional and Large-Sample Approximations

FULLER · Introduction to Statistical Time Series, *Second Edition*

† FULLER · Measurement Error Models

GALLANT · Nonlinear Statistical Models

GEISSER · Modes of Parametric Statistical Inference

GELMAN and MENG · Applied Bayesian Modeling and Causal Inference from Incomplete-Data Perspectives

GEWEKE · Contemporary Bayesian Econometrics and Statistics

GHOSH, MUKHOPADHYAY, and SEN · Sequential Estimation

GIESBRECHT and GUMPERTZ · Planning, Construction, and Statistical Analysis of Comparative Experiments

GIFI · Nonlinear Multivariate Analysis

GIVENS and HOETING · Computational Statistics

* Now available in a lower priced paperback edition in the Wiley Classics Library.

† Now available in a lower priced paperback edition in the Wiley-Interscience Paperback Series.

GLASSERMAN and YAO · Monotone Structure in Discrete-Event Systems

GNANADESIKAN · Methods for Statistical Data Analysis of Multivariate Observations, *Second Edition*

GOLDSTEIN · Multilevel Statistical Models, *Fourth Edition*

GOLDSTEIN and LEWIS · Assessment: Problems, Development, and Statistical Issues

GOLDSTEIN and WOOFF · Bayes Linear Statistics

GREENWOOD and NIKULIN · A Guide to Chi-Squared Testing

GROSS, SHORTLE, THOMPSON, and HARRIS · Fundamentals of Queueing Theory, *Fourth Edition*

GROSS, SHORTLE, THOMPSON, and HARRIS · Solutions Manual to Accompany Fundamentals of Queueing Theory, *Fourth Edition*

* HAHN and SHAPIRO · Statistical Models in Engineering

HAHN and MEEKER · Statistical Intervals: A Guide for Practitioners

HALD · A History of Probability and Statistics and their Applications Before 1750

HALD · A History of Mathematical Statistics from 1750 to 1930

† HAMPEL · Robust Statistics: The Approach Based on Influence Functions

HANNAN and DEISTLER · The Statistical Theory of Linear Systems

HARMAN and KULKARNI · An Elementary Introduction to Statistical Learning Theory

HARTUNG, KNAPP, and SINHA · Statistical Meta-Analysis with Applications

HEIBERGER · Computation for the Analysis of Designed Experiments

HEDAYAT and SINHA · Design and Inference in Finite Population Sampling

HEDEKER and GIBBONS · Longitudinal Data Analysis

HELLER · MACSYMA for Statisticians

HERITIER, CANTONI, COPT, and VICTORIA-FESER · Robust Methods in Biostatistics

HINKELMANN and KEMPTHORNE · Design and Analysis of Experiments, Volume 1: Introduction to Experimental Design, *Second Edition*

HINKELMANN and KEMPTHORNE · Design and Analysis of Experiments, Volume 2: Advanced Experimental Design

HINKELMANN (editor) · Design and Analysis of Experiments, Volume 3: Special Designs and Applications

HOAGLIN, MOSTELLER, and TUKEY · Fundamentals of Exploratory Analysis of Variance

* HOAGLIN, MOSTELLER, and TUKEY · Exploring Data Tables, Trends and Shapes

* HOAGLIN, MOSTELLER, and TUKEY · Understanding Robust and Exploratory Data Analysis

* Now available in a lower priced paperback edition in the Wiley Classics Library.

† Now available in a lower priced paperback edition in the Wiley-Interscience Paperback Series.

HOCHBERG and TAMHANE · Multiple Comparison Procedures

HOCKING · Methods and Applications of Linear Models: Regression and the Analysis of Variance, *Second Edition*

HOEL · Introduction to Mathematical Statistics, *Fifth Edition*

HOGG and KLUGMAN · Loss Distributions

HOLLANDER and WOLFE · Nonparametric Statistical Methods, *Second Edition*

HOSMER and LEMESHOW · Applied Logistic Regression, *Second Edition*

HOSMER, LEMESHOW, and MAY · Applied Survival Analysis: Regression Modeling of Time-to-Event Data, *Second Edition*

HUBER · Data Analysis: What Can Be Learned From the Past 50 Years

HUBER · Robust Statistics

† HUBER and RONCHETTI · Robust Statistics, *Second Edition*

HUBERTY · Applied Discriminant Analysis, *Second Edition*

HUBERTY and OLEJNIK · Applied MANOVA and Discriminant Analysis, *Second Edition*

HUITEMA · The Analysis of Covariance and Alternatives: Statistical Methods for Experiments, Quasi-Experiments, and Single-Case Studies, *Second Edition*

HUNT and KENNEDY · Financial Derivatives in Theory and Practice, *Revised Edition*

HURD and MIAMEE · Periodically Correlated Random Sequences: Spectral Theory and Practice

HUSKOVA, BERAN, and DUPAC · Collected Works of Jaroslav Hajek—with Commentary

HUZURBAZAR · Flowgraph Models for Multistate Time-to-Event Data

IMAN and CONOVER · A Modern Approach to Statistics

JACKMAN · Bayesian Analysis for the Social Sciences

† JACKSON · A User's Guide to Principle Components

JOHN · Statistical Methods in Engineering and Quality Assurance

JOHNSON · Multivariate Statistical Simulation

JOHNSON and BALAKRISHNAN · Advances in the Theory and Practice of Statistics: A Volume in Honor of Samuel Kotz

JOHNSON and BHATTACHARYYA · Statistics: Principles and Methods, *Fifth Edition*

JOHNSON, KEMP, and KOTZ · Univariate Discrete Distributions, *Third Edition*

JOHNSON and KOTZ · Distributions in Statistics

JOHNSON and KOTZ (editors) · Leading Personalities in Statistical Sciences: From the Seventeenth Century to the Present

JOHNSON, KOTZ, and BALAKRISHNAN · Continuous Univariate Distributions, Volume 1, *Second Edition*

†Now available in a lower priced paperback edition in the Wiley–Interscience Paperback Series.

JOHNSON, KOTZ, and BALAKRISHNAN · Continuous Univariate Distributions, Volume 2, *Second Edition*

JOHNSON, KOTZ, and BALAKRISHNAN · Discrete Multivariate Distributions

JUDGE, GRIFFITHS, HILL, LÜTKEPOHL, and LEE · The Theory and Practice of Econometrics, *Second Edition*

JUREČ KOVÁ and SEN · Robust Statistical Procedures: Aymptotics and Interrelations

JUREK and MASON · Operator-Limit Distributions in Probability Theory

KADANE · Bayesian Methods and Ethics in a Clinical Trial Design

KADANE AND SCHUM · A Probabilistic Analysis of the Sacco and Vanzetti Evidence

KALBFLEISCH and PRENTICE · The Statistical Analysis of Failure Time Data, *Second Edition*

KARIYA and KURATA · Generalized Least Squares

KASS and VOS · Geometrical Foundations of Asymptotic Inference

† KAUFMAN and ROUSSEEUW · Finding Groups in Data: An Introduction to Cluster Analysis

KEDEM and FOKIANOS · Regression Models for Time Series Analysis

KENDALL, BARDEN, CARNE, and LE · Shape and Shape Theory

KHURI · Advanced Calculus with Applications in Statistics, *Second Edition*

KHURI, MATHEW, and SINHA · Statistical Tests for Mixed Linear Models

* KISH · Statistical Design for Research

KLEIBER and KOTZ · Statistical Size Distributions in Economics and Actuarial Sciences

KLEMELÄ · Smoothing of Multivariate Data: Density Estimation and Visualization

KLUGMAN, PANJER, and WILLMOT · Loss Models: From Data to Decisions, *Third Edition*

KLUGMAN, PANJER, and WILLMOT · Solutions Manual to Accompany Loss Models: From Data to Decisions, *Third Edition*

KOSKI and NOBLE · Bayesian Networks: An Introduction

KOTZ, BALAKRISHNAN, and JOHNSON · Continuous Multivariate Distributions, Volume 1, *Second Edition*

KOTZ and JOHNSON (editors) · Encyclopedia of Statistical Sciences: Volumes 1 to 9 with Index

KOTZ and JOHNSON (editors) · Encyclopedia of Statistical Sciences: Supplement Volume

KOTZ, READ, and BANKS (editors) · Encyclopedia of Statistical Sciences: Update Volume 1

*Now available in a lower priced paperback edition in the Wiley Classics Library.

†Now available in a lower priced paperback edition in the Wiley-Interscience Paperback Series.

KOTZ, READ, and BANKS (editors) · Encyclopedia of Statistical Sciences:
Update Volume 2

KOVALENKO, KUZNETZOV, and PEGG · Mathematical Theory of Reliability
of Time-Dependent Systems with Practical Applications

KOWALSKI and TU · Modern Applied U-Statistics

KRISHNAMOORTHY and MATHEW · Statistical Tolerance Regions: Theory,
Applications, and Computation

KROESE, TAIMRE, and BOTEV · Handbook of Monte Carlo Methods

KROONENBERG · Applied Multiway Data Analysis

KULINSKAYA, MORGENTHALER, and STAUDTE · Meta Analysis: A
Guide to Calibrating and Combining Statistical Evidence

KUROWICKA and COOKE · Uncertainty Analysis with High Dimensional
Dependence Modelling

KVAM and VIDAKOVIC · Nonparametric Statistics with Applications to
Science and Engineering

LACHIN · Biostatistical Methods: The Assessment of Relative Risks, *Second
Edition*

LAD · Operational Subjective Statistical Methods: A Mathematical,
Philosophical, and Historical Introduction

LAMPERTI · Probability: A Survey of the Mathematical Theory, *Second Edition*

LANGE, RYAN, BILLARD, BRILLINGER, CONQUEST, and
GREENHOUSE · Case Studies in Biometry

LARSON · Introduction to Probability Theory and Statistical Inference, *Third
Edition*

LAWLESS · Statistical Models and Methods for Lifetime Data, *Second Edition*

LAWSON · Statistical Methods in Spatial Epidemiology, *Second Edition*

LE · Applied Categorical Data Analysis

LE · Applied Survival Analysis

LEE · Structural Equation Modeling: A Bayesian Approach

LEE and WANG · Statistical Methods for Survival Data Analysis, *Third Edition*

LEPAGE and BILLARD · Exploring the Limits of Bootstrap

LEYLAND and GOLDSTEIN (editors) · Multilevel Modelling of Health
Statistics

LIAO · Statistical Group Comparison

LINDVALL · Lectures on the Coupling Method

LIN · Introductory Stochastic Analysis for Finance and Insurance

LINHART and ZUCCHINI · Model Selection

LITTLE and RUBIN · Statistical Analysis with Missing Data, *Second Edition*

LLOYD · The Statistical Analysis of Categorical Data

LOWEN and TEICH · Fractal-Based Point Processes

MAGNUS and NEUDECKER · Matrix Differential Calculus with Applications
in Statistics and Econometrics, *Revised Edition*

MALLER and ZHOU · Survival Analysis with Long Term Survivors

MALLOWS · Design, Data, and Analysis by Some Friends of Cuthbert Daniel
MANN, SCHAFER, and SINGPURWALLA · Methods for Statistical Analysis
of Reliability and Life Data

MANTON, WOODBURY, and TOLLEY · Statistical Applications Using Fuzzy
Sets

MARCHETTE · Random Graphs for Statistical Pattern Recognition

MARDIA and JUPP · Directional Statistics

MARKOVICH · Nonparametric Analysis of Univariate Heavy-Tailed Data:
Research and Practice

MARONNA, MARTIN and YOHAI · Robust Statistics: Theory and Methods

MASON, GUNST, and HESS · Statistical Design and Analysis of Experiments
with Applications to Engineering and Science, *Second Edition*

McCULLOCH, SEARLE, and NEUHAUS · Generalized, Linear, and Mixed
Models, *Second Edition*

McFADDEN · Management of Data in Clinical Trials, *Second Edition*

* McLACHLAN · Discriminant Analysis and Statistical Pattern Recognition

McLACHLAN, DO, and AMBROISE · Analyzing Microarray Gene Expression
Data

McLACHLAN and KRISHNAN · The EM Algorithm and Extensions, *Second
Edition*

McLACHLAN and PEEL · Finite Mixture Models

McNEIL · Epidemiological Research Methods

MEEKER and ESCOBAR · Statistical Methods for Reliability Data

MEERSCHAERT and SCHEFFLER · Limit Distributions for Sums of
Independent Random Vectors: Heavy Tails in Theory and Practice

MENGERSEN, ROBERT, and TITTERINGTON · Mixtures: Estimation and
Applications

MICKEY, DUNN, and CLARK · Applied Statistics: Analysis of Variance and
Regression, *Third Edition*

* MILLER · Survival Analysis, *Second Edition*

MONTGOMERY, JENNINGS, and KULAHCI · Introduction to Time Series
Analysis and Forecasting

MONTGOMERY, PECK, and VINING · Introduction to Linear Regression
Analysis, *Fifth Edition*

MORGENTHALER and TUKEY · Configural Polysampling: A Route to
Practical Robustness

MUIRHEAD · Aspects of Multivariate Statistical Theory

MULLER and STOYAN · Comparison Methods for Stochastic Models and
Risks

*Now available in a lower priced paperback edition in the Wiley Classics Library.

MURRAY · X-STAT 2.0 Statistical Experimentation, Design Data Analysis, and Nonlinear Optimization

MURTHY, XIE, and JIANG · Weibull Models

MYERS, MONTGOMERY, and ANDERSON-COOK · Response Surface Methodology: Process and Product Optimization Using Designed Experiments, *Third Edition*

MYERS, MONTGOMERY, VINING, and ROBINSON · Generalized Linear Models. With Applications in Engineering and the Sciences, *Second Edition*

† NELSON · Accelerated Testing, Statistical Models, Test Plans, and Data Analyses

† NELSON · Applied Life Data Analysis

NEWMAN · Biostatistical Methods in Epidemiology

OCHI · Applied Probability and Stochastic Processes in Engineering and Physical Sciences

OKABE, BOOTS, SUGIHARA, and CHIU · Spatial Tessellations: Concepts and Applications of Voronoi Diagrams, *Second Edition*

OLIVER and SMITH · Influence Diagrams, Belief Nets and Decision Analysis

PALTA · Quantitative Methods in Population Health: Extensions of Ordinary Regressions

PANJER · Operational Risk: Modeling and Analytics

PANKRATZ · Forecasting with Dynamic Regression Models

PANKRATZ · Forecasting with Univariate Box-Jenkins Models: Concepts and Cases

PARDOUX · Markov Processes and Applications: Algorithms, Networks, Genome and Finance

* PARZEN · Modern Probability Theory and Its Applications

PEÑA, TIAO, and TSAY · A Course in Time Series Analysis

PIANTADOSI · Clinical Trials: A Methodologic Perspective

PORT · Theoretical Probability for Applications

POURAHMADI · Foundations of Time Series Analysis and Prediction Theory

POWELL · Approximate Dynamic Programming: Solving the Curses of Dimensionality, *Second Edition*

POWELL and RYZHOV · Optimal Learning

PRESS · Bayesian Statistics: Principles, Models, and Applications

PRESS · Subjective and Objective Bayesian Statistics, *Second Edition*

PRESS and TANUR · The Subjectivity of Scientists and the Bayesian Approach

PUKELSHEIM · Optimal Experimental Design

PURI, VILAPLANA, and WERTZ · New Perspectives in Theoretical and Applied Statistics

† PUTERMAN · Markov Decision Processes: Discrete Stochastic Dynamic Programming

* Now available in a lower priced paperback edition in the Wiley Classics Library.

† Now available in a lower priced paperback edition in the Wiley-Interscience Paperback Series.

QIU · Image Processing and Jump Regression Analysis
 * RAO · Linear Statistical Inference and Its Applications, *Second Edition*
 RAO · Statistical Inference for Fractional Diffusion Processes
 RAUSAND and HØYLAND · System Reliability Theory: Models, Statistical
 Methods, and Applications, *Second Edition*
 RAYNER · Smooth Tests of Goodnes of Fit: Using R, *Second Edition*
 RENCHER · Linear Models in Statistics
 RENCHER · Methods of Multivariate Analysis, *Second Edition*
 RENCHER · Multivariate Statistical Inference with Applications
 * RIPLEY · Spatial Statistics
 * RIPLEY · Stochastic Simulation
 ROBINSON · Practical Strategies for Experimenting
 ROHATGI and SALEH · An Introduction to Probability and Statistics, *Second
 Edition*
 ROLSKI, SCHMIDLI, SCHMIDT, and TEUGELS · Stochastic Processes for
 Insurance and Finance
 ROSENBERGER and LACHIN · Randomization in Clinical Trials: Theory and
 Practice
 ROSS · Introduction to Probability and Statistics for Engineers and Scientists
 ROSSI, ALLENBY, and MCCULLOCH · Bayesian Statistics and Marketing
 † ROUSSEEUW and LEROY · Robust Regression and Outlier Detection
 ROYSTON and SAUERBREI · Multivariate Model Building: A Pragmatic
 Approach to Regression Analysis Based on Fractional Polynomials for
 Modeling Continuous Variables
 * RUBIN · Multiple Imputation for Nonresponse in Surveys
 RUBINSTEIN and KROESE · Simulation and the Monte Carlo Method, *Second
 Edition*
 RUBINSTEIN and MELAMED · Modern Simulation and Modeling
 RYAN · Modern Engineering Statistics
 RYAN · Modern Experimental Design
 RYAN · Modern Regression Methods, *Second Edition*
 RYAN · Statistical Methods for Quality Improvement, *Third Edition*
 SALEH · Theory of Preliminary Test and Stein-Type Estimation with
 Applications
 SALTELLI, CHAN, and SCOTT (editors) · Sensitivity Analysis
 * SCHEFFE · The Analysis of Variance
 SCHIMEK · Smoothing and Regression: Approaches, Computation, and
 Application
 SCHOTT · Matrix Analysis for Statistics, *Second Edition*

* Now available in a lower priced paperback edition in the Wiley Classics Library.

† Now available in a lower priced paperback edition in the Wiley-Interscience Paperback Series.

SCHOUTENS · Levy Processes in Finance: Pricing Financial Derivatives
SCHUSS · Theory and Applications of Stochastic Differential Equations
SCOTT · Multivariate Density Estimation: Theory, Practice, and Visualization
* SEARLE · Linear Models
† SEARLE · Linear Models for Unbalanced Data
† SEARLE · Matrix Algebra Useful for Statistics
† SEARLE, CASELLA, and McCULLOCH · Variance Components
SEARLE and WILLETT · Matrix Algebra for Applied Economics
SEBER · A Matrix Handbook For Statisticians
† SEBER · Multivariate Observations
SEBER and LEE · Linear Regression Analysis, *Second Edition*
† SEBER and WILD · Nonlinear Regression
SENNOTT · Stochastic Dynamic Programming and the Control of Queueing
Systems
* SERFLING · Approximation Theorems of Mathematical Statistics
SHAFER and VOVK · Probability and Finance: It's Only a Game!
SHERMAN · Spatial Statistics and Spatio-Temporal Data: Covariance Functions
and Directional Properties
SILVAPULLE and SEN · Constrained Statistical Inference: Inequality, Order,
and Shape Restrictions
SINGPURWALLA · Reliability and Risk: A Bayesian Perspective
SMALL and MCLEISH · Hilbert Space Methods in Probability and Statistical
Inference
SRIVASTAVA · Methods of Multivariate Statistics
STAPLETON · Linear Statistical Models, *Second Edition*
STAPLETON · Models for Probability and Statistical Inference: Theory and
Applications
STAUDTE and SHEATHER · Robust Estimation and Testing
STOYAN, KENDALL, and MECKE · Stochastic Geometry and Its Applications,
Second Edition
STOYAN and STOYAN · Fractals, Random Shapes and Point Fields: Methods of
Geometrical Statistics
STREET and BURGESS · The Construction of Optimal Stated Choice
Experiments: Theory and Methods
STYAN · The Collected Papers of T. W. Anderson: 1943–1985
SUTTON, ABRAMS, JONES, SHELDON, and SONG · Methods for Meta-
Analysis in Medical Research
TAKEZAWA · Introduction to Nonparametric Regression
TAMHANE · Statistical Analysis of Designed Experiments: Theory and
Applications

* Now available in a lower priced paperback edition in the Wiley Classics Library.

† Now available in a lower priced paperback edition in the Wiley–Interscience Paperback Series.

TANAKA · Time Series Analysis: Nonstationary and Noninvertible Distribution Theory

THOMPSON · Empirical Model Building: Data, Models, and Reality, *Second Edition*

THOMPSON · Sampling, *Third Edition*

THOMPSON · Simulation: A Modeler's Approach

THOMPSON and SEBER · Adaptive Sampling

THOMPSON, WILLIAMS, and FINDLAY · Models for Investors in Real World Markets

TIAO, BISGAARD, HILL, PEÑA, and STIGLER (editors) · Box on Quality and Discovery: with Design, Control, and Robustness

TIERNEY · LISP-STAT: An Object-Oriented Environment for Statistical Computing and Dynamic Graphics

TSAY · Analysis of Financial Time Series, *Third Edition*

UPTON and FINGLETON · Spatial Data Analysis by Example, Volume II: Categorical and Directional Data

† VAN BELLE · Statistical Rules of Thumb, *Second Edition*

VAN BELLE, FISHER, HEAGERTY, and LUMLEY · Biostatistics: A Methodology for the Health Sciences, *Second Edition*

VESTRUP · The Theory of Measures and Integration

VIDAKOVIC · Statistical Modeling by Wavelets

VINOD and REAGLE · Preparing for the Worst: Incorporating Downside Risk in Stock Market Investments

WALLER and GOTWAY · Applied Spatial Statistics for Public Health Data

WEERAHANDI · Generalized Inference in Repeated Measures: Exact Methods in MANOVA and Mixed Models

WEISBERG · Applied Linear Regression, *Third Edition*

WEISBERG · Bias and Causation: Models and Judgment for Valid Comparisons

WELSH · Aspects of Statistical Inference

WESTFALL and YOUNG · Resampling-Based Multiple Testing: Examples and Methods for p -Value Adjustment

* WHITTAKER · Graphical Models in Applied Multivariate Statistics

WINKER · Optimization Heuristics in Economics: Applications of Threshold Accepting

WONNACOTT and WONNACOTT · Econometrics, *Second Edition*

WOODING · Planning Pharmaceutical Clinical Trials: Basic Statistical Principles

WOODWORTH · Biostatistics: A Bayesian Introduction

WOOLSON and CLARKE · Statistical Methods for the Analysis of Biomedical Data, *Second Edition*

* Now available in a lower priced paperback edition in the Wiley Classics Library.

† Now available in a lower priced paperback edition in the Wiley-Interscience Paperback Series.

WU and HAMADA · Experiments: Planning, Analysis, and Parameter Design Optimization, *Second Edition*

WU and ZHANG · Nonparametric Regression Methods for Longitudinal Data Analysis

YANG · The Construction Theory of Denumerable Markov Processes

YIN · Clinical Trial Design: Bayesian and Frequentist Adaptive Methods

YOUNG, VALERO-MORA, and FRIENDLY · Visual Statistics: Seeing Data with Dynamic Interactive Graphics

ZACKS · Stage-Wise Adaptive Designs

* ZELLNER · An Introduction to Bayesian Inference in Econometrics

ZELTERMAN · Discrete Distributions—Applications in the Health Sciences

ZHOU, OBUCHOWSKI, and MCCLISH · Statistical Methods in Diagnostic Medicine, *Second Edition*

*Now available in a lower priced paperback edition in the Wiley Classics Library.